

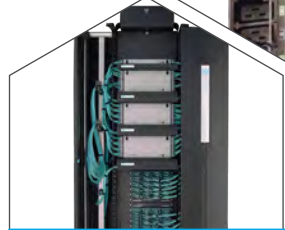

CHATSWORTH
PRODUCTS

PRODUCT CATALOG

v.28



CPI WEBSITE

Visit Chatsworth Products' (CPI) website at [chatsworth.com](https://www.chatsworth.com) to find, filter and compare thousands of products, as well as view documentation, create a shopping cart and purchase from an authorized CPI partner. You will also find product configurators, selectors, estimators and downloadable design tools.



Online Chat

The CPI website now offers online chat for customers who need assistance while using our website. You will benefit from one-on-one, real-time interaction with CPI's helpful employees.



CPI Product Designer

Many of our enclosures can be configured online using the CPI Product Designer. CPI Product Designer will generate bills of material, drawings, 3D models and sales documents automatically. Once the design is finished, you will receive a confirmation email with the product's description, part number, and bill of material with pricing and related documents. Visit [chatsworth.com/product-designer](https://www.chatsworth.com/product-designer).



Power Selector

Visit [selectapdu.com](https://www.selectapdu.com) to select the best power product for your application by narrowing down options based on your requirements. You can compare several products at one time and then email or print the results.



CPI Video Library

Take advantage of the many videos on [video.chatsworth.com](https://www.video.chatsworth.com). You'll find helpful how-to videos, product feature videos and solution overviews.



On-Demand Courses

CPI offers courses that have been approved by BICSI and the American Institute of Architects (AIA) for continuing education credits (CECs). These courses are presented by CPI's highly-trained and experienced professionals. Visit [chatsworth.com/training-center/cec-courses](https://www.chatsworth.com/training-center/cec-courses).

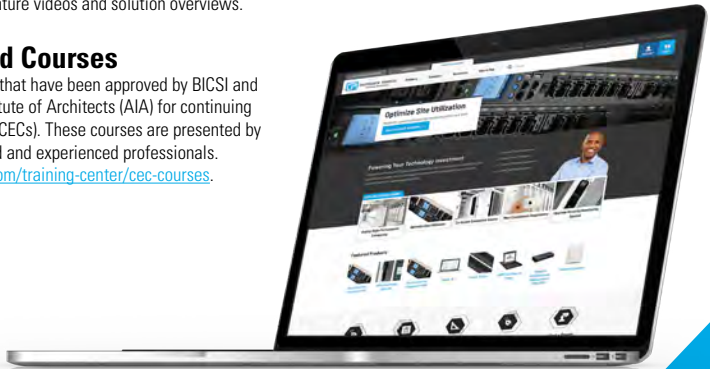

| | |
|--|-----------------------|
| Introduction | Pages i - viii |
| Cabinet & Aisle Containment Systems | Section 1 |
| Cable Management Products | Section 2 |
| Cable Runway & Tray Products | Section 3 |
| Environmental Monitoring & Security Systems | Section 4 |
| Bonding & Grounding Products | Section 5 |
| Industrial Enclosure Systems | Section 6 |
| Power Management Products | Section 7 |
| Rack Systems | Section 8 |
| Seismic Protection Systems | Section 9 |
| Wall-Mount Systems | Section 10 |
| Zone Cabling & Wireless Enclosures | Section 11 |
| Index: Part Number & Product | Section 12 |

To know Chatsworth Products (CPI) is to know our motto – “Delight the Customer.” As an employee-owned company, it is important for us to work with you on an individual basis to deliver quality products and services that protect your technology investment. Whether you are placing an order through customer service or clarifying a project through technical support, CPI’s team of experienced professionals will help find a solution that works best for you and your business. This dedication to solving the needs of customers led to providing our most popular products for IT infrastructure solutions in this catalog. If there is something you cannot find, give us a call at 800-834-4969, and we will be happy to delight you too!

What We Do

Chatsworth Products (CPI) is a global manufacturer of products and solutions that protect your ever-growing investment in information and communications technology for IT and industrial automation applications. We act as your business partner and are uniquely prepared to respond to your requirements with global availability and rapid product customization, giving you a competitive advantage. With decades of experience engineering thermal, power and cable management solutions for the data center, enterprise networking and industrial enclosure markets, CPI is well positioned to provide you with unequalled application expertise, customer service and technical support, and a global network of industry-leading distributors.

Headquartered in the United States, CPI operates from multiple sites worldwide, including offices in Mexico, Canada, China, Qatar, the United Arab Emirates and the United Kingdom. CPI’s manufacturing facilities are located in the United States, Asia and Europe.



WHY CHOOSE CPI?

History

CPI began in 1991 when 90 employees joined together and purchased the Dracon Division of Harris Corp. using an Employee Stock Ownership Plan (ESOP). With deregulation in the telecommunications industry and technological innovation in voice and data equipment, CPI focused on the explosive needs of the information technology market to manage IT infrastructure equipment. Today, CPI is a leading global supplier of integrated solutions that optimize information and communications technology (ICT) equipment, including power management solutions and industrial enclosures.

Who We Serve

Whether it is supporting a small network or a large colocation data center, CPI has the experience and know-how to provide the right solution at the right time.

Some of the markets we have served include:

- Banking & Financial Services
- Education
- Electronics
- Government (Federal, State and Local)
- Health Care & Medical
- Hyperscale and Multitenant Data Centers
- Industrial
- Information Technology
- Insurance
- Manufacturing & Automation
- Media & Entertainment
- Pharmaceutical & Biotech
- Real Estate
- Retail
- Security
- Telecommunications
- Transportation

CPI is committed to being a company of the highest quality in every aspect of its business, providing Quality Products, Quality Services and most of all—Quality People.

Customized Solutions

A great deal of thought and precision goes into the design of today's enterprise networks, but plans can change in an instant. Each step comes with its own set of obstacles, from a need to maintain energy costs through thermal management solutions, to the deployment of quality-built cabinets that can withstand high-density loads and earthquakes. As the environment within data centers continually changes, infrastructure systems must be able to change too. That is why CPI provides the marketplace with high-quality, scalable solutions that allow for future technology and evolving standards.

Leading The Way in Research, Development & Training

With the financial strength to reinvest in the company and continually improve manufacturing and logistical processes, CPI has become an industry leader in product innovation and excellence. Complementing our numerous active patents for groundbreaking product designs, CPI has its own Research Development and Training (RD&T) Center in Georgetown, Texas. Designed with customers in mind, the RD&T Center is a comprehensive facility complete with a Product Showroom, Customer Meeting Center and state-of-the-art training facilities.

Additionally, CPI product showrooms are located around the globe to provide our customers the opportunity to inspect our products, and see the functionality and quality firsthand. For more information or to schedule a visit to one of our showrooms, visit chatsworth.com.

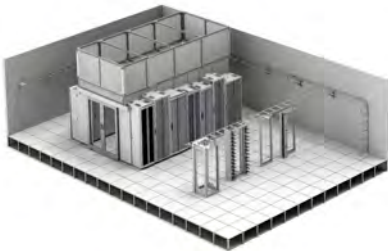

Value-Added Online Tools

CPI considers every aspect of project planning, providing the tools and resources our customers need to get the job done. CPI provides a robust set of design tools on our website at chatsworth.com to help you plan designs and solutions for any IT infrastructure need. These tools include the CPI Product Designer, Building Information Modeling (BIM) drawings, CAD Blocks, Visio® Shapes, and much more.

Thought Leadership

CPI supports the thought leadership, standards development and knowledge sharing activities of the following industry associations:

- American Society of Heating, Refrigeration and Air Conditioning Engineers (ASHRAE)
- Armed Forces Communications and Electronics Assoc. (AFCEA)
- Association for Computer Operations Management (AFCOM)
- Building Industries Consulting Service International (BICSI)
- Electronic Industries Alliance (EIA)
- Employee-Ownership (ESOP) Association
- International Society of Automation (ISA)
- International Organization for Standardization (ISO)
- National Electrical Contractors Association (NECA)
- National Electrical Manufacturers Association (NEMA)
- Community Member of the Open Compute Project™
- Society of Telecommunications Consultants (STC)
- Telecommunications Industry Association (TIA)
- The Green Grid
- Underwriters Laboratories, Inc.
- Uptime Institute
- US Green Building Council



Expert Service and Support

CPI understands that the high-speed world of data management is constantly changing and for this reason, we offer highly trained Technical Support Specialists and Customer Service Representatives who are ready to assist quickly and accurately to keep your project on track. To further assist with your IT infrastructure needs, CPI Sales Managers and Field Application Engineers are available to meet with you onsite, discuss your business needs, assess your current infrastructure and recommend solutions that will gain you the best return on your investment.

CPI GLOBAL OFFICES:

Corporate Office - Agoura Hills, CA

818-735-6100 • 818-735-6199 FAX

Chatsworth, CA Operations

818-882-8595 • 818-718-0473 FAX

New Bern, NC Operations

252-514-2779 • 252-514-2977 FAX

Georgetown, TX Operations

512-863-7800 • 512-869-1374 FAX

Round Rock, TX Technology Center

737-808-9200

Asia Pacific

Jing'an District, Shanghai, China

+86-21-6880-0266

chatsworth.com.cn

Latin America

Mexico City, Mexico

+52-55-5203-7525, toll free: 01-800-201-7592

chatsworth.com.co

Europe

Buckinghamshire, England, United Kingdom

+44-01628-524-834

chatsworth.com

Middle East & Africa

Dubai, UAE +971-4-2602125

Qatar +974-4-267422

chatsworth.com

Canada

Vaughan, Ontario, Canada

+905-850-7770

chatsworth.com

For answers to your questions or for custom solutions, please call

Customer Service or Technical Support at:

1-800-834-4969 (toll free in the U.S. & Canada)

Monday - Friday, 5 a.m. - 5 p.m., Pacific Time

1-818-739-3400 (outside of the U.S. & Canada),

or email Technical Support at techsupport@chatsworth.com



HOW TO ORDER

CPI sales are conducted in partnership with a global network of distributors, contractors and resellers. Whether visiting your local distribution center, or ordering online, you will find a high level of stock availability. This availability, along with CPI's consistently short factory lead times, assures that CPI solutions will be accessible to meet your project scheduling needs. To obtain a purchase price quote and product availability, please locate the CPI partner nearest you by calling 800-834-4969.

This catalog has been developed according to comprehensive product groups. Each group is presented as a convenient section within the catalog and contains part numbers, ordering information and detailed illustrations or photographs.

To Order, Follow These Simple Steps:

1. Locate desired product(s) within the appropriate section.
2. Use the complete part number. Pay close attention to the digits indicating product variations such as size, finish (refer to Color Finishes information) and hole pattern.
3. Check "Kit includes" information of each product for a listing of all components and hardware included with the part number.
4. Check to see if product descriptions include "Order Separately." These components are not included with the product; however, most of these items are contained in the catalog and may be ordered. Please see part number references where indicated.
5. Indicate quantity and full part numbers in your purchase orders (POs). The description is not essential but should be included when ordering. The product description will appear on your acknowledgment, invoice and packing list.
6. Locate a distributor by calling 800-834-4969 or visiting chatsworth.com. If you are an authorized CPI distributor, send POs via email or fax to one of our Customer Service Department locations listed to the right.
7. Questions? Call CPI toll free at 800-834-4969 within the United States and Canada, or visit chatsworth.com.

Note: Prices and quantity breakdowns are not listed in this product guide. For product pricing, please contact our Customer Service Department at 800-834-4969.

All orders received are subject to acceptance by CPI and are subject to a minimum charge of \$200.00. CPI must receive written confirmation for all orders prior to shipment.

Products listed do not include export packaging, insurance, taxes, tariffs or duties.

All pricing is subject to change. CPI reserves the right to make adjustments to pricing and product offerings for reasons including, but not limited to, changing market conditions, product discontinuations, product unavailability and price changes.



Federal, State and Local Government Business GSA Contract No. GS-35F-0184N

CPI is listed with the General Services Administration (GSA) under Federal Supply Schedule 70 for General Purpose Commercial Information Technology Equipment, Software and Services, is a Small Business manufacturer (SB) and is available through GSA Advantage, NETCENTS, SEWP III, NITAAC-ECSIII, GSA Connections, as well as other channels. For more information, visit chatsworth.com/gov.

Color Finishes

CPI utilizes a powder-coating finishing process to produce a durable, long-lasting finish that is aesthetically superior to other techniques. The majority of CPI Products are available in three colors (white, black and gray) and a grained metal finish referred to as "clear." CPI's powder-coating and curing techniques provide a more consistent, uniform finish. Therefore, the color is evenly applied (even on angles, die cuts or unique shapes) and does not vary among different products. CPI's "White" or "Computer White" is distinguished as "Computer Beige." These are the same colors and indicate an off-white color designed to coordinate with typical computer-white products. CPI's bright white cabinet color is designated as "Glacier White."

Customer Service Departments

Chatsworth, CA Operations

Ph: 818-882-8595 • Fax: 818-718-0473

Georgetown, TX Operations

Ph: 512-863-7800 • Fax: 512-869-1374

New Bern, NC Operations

Ph: 252-514-2779 • Fax: 252-514-2977

Buckinghamshire, England Office

Ph: +44-1628-524-834

Toronto, Canada Office

Ph: +905-850-7770

Shanghai, Asia Pacific Office

Ph: +86 21 6880-0266

Mexico City, Mexico Office

Ph: +50-55-5203-7525

Dubai, UAE Office

Ph: +971-4-2602125

Qatar Office

Ph: +974-4-4267422

1-800-834-4969 (toll free in the U.S. & Canada)

1-818-739-3400 (outside of the U.S. & Canada)

TERMS & CONDITIONS

CPI maintains a policy of continuous product improvement; therefore, we reserve the right to make changes without notice.

Products listed are F.O.B. Destination, prepaid and add to locations within the 48 contiguous states and do not include export packaging, insurance, taxes, tariffs or duties. For complete freight program details and information regarding export shipments, contact our Customer Service Department at 800-834-4969 in U.S. and Canada or 818-739-3400 outside U.S. and Canada.

All orders received are subject to acceptance by CPI. All orders are subject to a minimum charge of \$200 USD net per shipment. CPI must receive written confirmation for all orders prior to shipment. Payment Terms are Net 30 days or otherwise confirmed on orders.

WARRANTY

CPI-Branded Hardware Products

CPI warrants all CPI-branded hardware products to be free from defects in material and/or workmanship (CPI's Standard Limited Warranty) for a period of three (3) years following the date of purchase (the Original Warranty Period). The customer must contact CPI in writing or by oral communication confirmed in writing within the Original Warranty Period to report a product that the customer claims is defective. CPI reserves the sole and absolute right to determine whether or not the product or any part thereof is defective. In the event a product (or any part thereof) is determined by CPI to be defective (an Accepted Claim), CPI will provide a remanufactured or replacement product or part (the Replacement Product) at no cost to the customer and issue a Return Material Authorization (RMA) number.

In the case of an Accepted Claim, the customer shall be responsible for shipping back the defective product to CPI under the provided RMA number within 30 days following receipt of the Replacement Product. If the customer fails to do so, CPI has the right to invoice the customer for the price of the Replacement Product. Any exceptions to this return policy must be authorized by CPI in writing in advance. Freight charges for the return shipment of the defective product for an Accepted Claim shall be borne by the customer, unless the defect is reported by the customer to CPI in writing within the first 30 days following the customer's receipt of the original product. Any Replacement Product that has been provided under an Accepted Claim will be subject to CPI's Standard Limited Warranty for the remaining Warranty Period applicable to the original product or 90 days following the date of replacement, whichever occurs later.

CPI's Standard Limited Warranty and Extended Limited Warranty do not extend to CPI-branded hardware products that have been subjected to abuse, misuse, neglect, accident, improper use, or improper installation, operation, repair and maintenance (except to the extent provided by CPI authorized personnel), nor to products that have been altered or modified in any way by anyone other than CPI authorized personnel, in which case CPI's Standard Limited Warranty or Extended Limited Warranty shall be null and void. In no event will CPI will be liable for consequential damages, for loss, damage or expense directly or indirectly arising from the use of any of its branded products, for any inability to use materials or from any other cause.

All non-CPI branded products that are resold through CPI carry the original manufacturer's warranty, if any. All such warranty claims must be submitted directly to the original manufacturer in accordance with the terms of such warranty, if any.

Returns and Repairs

No products or part thereof shall be returned to CPI unless the customer first obtains a Return Material Authorization (RMA) number from a CPI customer service representative. This number must appear clearly and prominently on all shipping containers. Containers without labels will not be accepted. The customer can choose to have the product sent back "as is" or scrapped by CPI.



Extended Limited Warranty CPI-Branded Hardware Products

CPI allows customers to purchase an extended limited warranty (CPI's Extended Limited Warranty) on CPI-branded hardware products for two (2) additional years beyond the expiration of the Original Warranty Period. CPI's Extended Limited Warranty can be purchased concurrently with or separately from the initial purchase of the product until the expiration of the Original Warranty Period for that product. Please consult your CPI representative for the cost, terms and conditions of CPI's Extended Limited Warranty.

These limited warranty provisions are the exclusive warranties for any CPI-branded hardware products and set forth the exclusive remedies and procedures for claims under CPI's standard limited warranty and extended limited warranty.

CPI's standard limited warranty and extended limited warranty apply to CPI-branded hardware products only.

Disclaimer of warranty: except as expressly set forth herein, CPI makes no other warranties, express or implied, including, without limitation, any warranties of fitness for a particular use or purpose, merchantability, or non-infringement of any intellectual property rights.



CPI-Branded Electronic Products (Environmental Monitoring & Security; KVM Systems; Power Management)

| Part Number | Type | Manufacturer Suggested Retail Price of the Product Being Covered |
|----------------------------|----------------------------|--|
| L1-2YEXTWAR-ELECTRONICS-C | Electronic, Concurrent | Up to \$1700 |
| L1-2YEXTWAR-ELECTRONICS-NC | Electronic, Non-Concurrent | Up to \$1700 |
| L2-2YEXTWAR-ELECTRONICS-C | Electronic, Concurrent | \$1701 - \$3400 |
| L2-2YEXTWAR-ELECTRONICS-NC | Electronic, Non-Concurrent | \$1701 - \$3400 |
| L3-2YEXTWAR-ELECTRONICS-C | Electronic, Concurrent | \$3401 and above |
| L3-2YEXTWAR-ELECTRONICS-NC | Electronic, Non-Concurrent | \$3401 and above |

CPI-Branded Non-Electronic Products (Cabinet, Containment & Enclosure Systems; Cable Management; Cable Runway & Tray Products; Bonding & Grounding; Rack Systems; Seismic Protection Systems; Wall-Mount Systems; Zone & Wireless Enclosures)

| Part Number | Type | Manufacturer Suggested Retail Price of the Product Being Covered |
|-----------------------|--------------------------------|--|
| L1-2YEXTWAR-OTHER-C | Non-Electronic, Concurrent | Up to \$1700 |
| L1-2YEXTWAR-OTHER-NC | Non-Electronic, Non-Concurrent | Up to \$1700 |
| L2-2YEXTWAR-OTHERS-C | Non-Electronic, Concurrent | \$1701 - \$3400 |
| L2-2YEXTWAR-OTHERS-NC | Non-Electronic, Non-Concurrent | \$1701 - \$3400 |
| L3-2YEXTWAR-OTHER-C | Non-Electronic, Concurrent | \$3401 and above |
| L3-2YEXTWAR-OTHER-NC | Non-Electronic, Non-Concurrent | \$3401 and above |

Note: If the warranty needs to cover a CP or TS part number, which combines the CPI-Branded Electronic and Non-Electronic Hardware, then select warranty L3-2YEXTWAR-OTHER-NC.



ISO 9001 REGISTRATION

DQS Inc.
Chatsworth Products

| Operation | Certificate Registration No. |
|----------------|--------------------------------|
| Chatsworth, CA | 10002325 QM15 Ref. 10002325 |
| New Bern, NC | 10002325 QM15 Ref. 10004453 |
| Georgetown, TX | 10002325 QM15 Ref. 10004454 |
| Round Rock, TX | 10002325 QM15 Ref. 10017461 |

The UL® Registered Firm symbol indicates that the facility has passed UL's evaluation to the international quality standards of the International Organization for Standardization. This means the facility has been thoroughly monitored and has participated in an audit to determine compliance with a strict and comprehensive set of quality specifications. An appropriate quality system must be demonstrated to meet these specifications for quality in the relevant areas of design, development, production, assembly, final inspection and testing.

Non-CPI Registration Marks

- AT&T® is a registered trademark of AT&T Intellectual Property, Inc.
- AutoCAD® is a registered trademark of Autodesk, Inc.
- Cisco® is a registered trademark of Cisco Systems, Inc.
- Dell® is a registered trademark of Dell Inc.
- HP® is a registered trademark of Hewlett-Packard Development Company, L.P.
- IBM® is a registered trademark of IBM Corporation.
- Slip-on® is a registered trademark of Slip-on Lock Nut Company Corporation.
- Velcro® is a registered trademark of Velcro Industries B.V.
- Visio® is a registered trademark of Microsoft Corporation.
- Power IQ® is a registered trademark of Sunbird.
- Rejiband® is a registered trademark of Pemsas®.

All other trademarks belong to their respective companies.



The UL Classified symbol indicates that Underwriters Laboratories Inc. classifies the product as an equipment bonding conductor only.



The UL Listed symbol indicates the product is Listed to applicable UL Standards and requirements by Underwriters Laboratories Inc.



The cULus symbol indicates compliance with both Canadian and U.S. requirements by Underwriters Laboratories Inc.



The UL Component Recognition symbol is used on components that are part of a larger product or system.



The CE Marking is a European marking of conformity, indicating a product complies with the requirements of the applicable European laws with respect to safety, health environment and consumer protection.



Environmentally Safe

CPI is committed to recycling as the solution to environmental and landfill concerns and continues to pursue packaging solutions that are cost effective and environmentally friendly.

CUSTOMER SERVICE & TECHNICAL SUPPORT

Based on your specific requirements, our Technical Support Specialists can help design the precise layout for your data center, and provide a detailed bill of material (BOM) complete with layout and assembly drawings. Furthermore, our Customer Service Representatives work closely with distributors to maintain product availability, ultimately helping preserve your project's scheduling requirements.

Contact Customer Service or Technical Support in the U.S. & Canada at 800-834-4969, or outside the U.S. & Canada, at +818-739-3400 (Monday - Friday, 5 a.m. - 5 p.m., Pacific Time).

You can also chat with a Customer Service Representative using our website chat tool or email Technical Support at techsupport@chatsworth.com.

Design Tools

CPI provides a robust set of design tools at chatsworth.com to help you plan designs and solutions for most IT infrastructure needs.

These tools include:

- Building Information Modeling (BIM) Library
- Cable Fill Tables
- CAD Blocks
- CPI Product Designer
- eConnect® Secure Array® Cost Savings Estimator
- MasterFormat® Division 27 Specifications
- OSHPD Pre-Approved Products
- Power Selector
- Video Library
- Visio® Shapes

The CPI Mobile App Suite, for both Apple and Google devices, is a collection of tools developed by CPI to help IT and telecommunications professionals determine cable fill, select server cabinets, identify the best power distribution unit (PDU), and create bills of material (BOM) for cable pathway, while on the go. Quickly find a CPI distributor near you at chatsworth.com/en-us/how-to-buy/find-a-distributor.

CPI Product Designer

CPI Product Designer allows you to create enclosures quickly and easily by allowing you to select the size, features and accessories needed for a specific application. CPI Product Designer will generate bills of material, drawings, 3D models and sales documents automatically. Once the design is finished, you will receive a confirmation email with the product's description, part number, and bill of material with pricing and related documents. To access, go to chatsworth.com/en-us/resources/configurators-and-estimators/product-designer.



CPI Website

Visit chatsworth.com to use our design tools, estimators and configurators to determine the best solution for your business. You can locate, select and compare products on our website, add to a cart, then send to your local distributor for purchase. Use the website to find your nearest CPI Sales Manager, authorized distributor, or value-added reseller.

CPI Newsletter and Blog

Stay up to date with the latest news from CPI. Read our weekly blog Cross-Connect, at chatsworth.com/blog and take advantage of our monthly newsletter, "The Source" at chatsworth.com/subscribe.

Buy American

Upon request, CPI is pleased to provide interested parties with a Certificate of Origin and Buy American Act and Buy America Act Compliance Certificate for all applicable part numbers. CPI Manufactured in American with globally sourced components.





SECTION 1

CABINET & AISLE CONTAINMENT SYSTEMS

| | | | |
|---|------|--|------|
| Cabinet Comparison Chart..... | 1-3 | Z4-Series SeismicFrame® Cabinet..... | 1-35 |
| ZetaFrame™ Cabinet..... | 1-4 | Cabinet Accessories & Shelves..... | 1-41 |
| F-Series TeraFrame® Gen 3 Cabinet..... | 1-14 | Aisle Containment Solutions..... | 1-48 |
| GF-Series GlobalFrame® Gen 2 Cabinet..... | 1-16 | Build To Spec (BTS) Containment (HAC)..... | 1-52 |
| N-Series TeraFrame® Gen 3 Cabinet..... | 1-28 | Wire Cage Enclosures..... | 1-53 |

CABINET & AISLE CONTAINMENT SYSTEMS

Section Update:

Zetaframe™ Cabinet System

Page 1-4

Where Can I Learn More?

To learn more about CPI's Cabinet & Aisle Containment Systems, or to find additional part numbers not listed in this catalog, please visit our website, chatsworth.com

Related Tools:

Use these tools, under the Resources tab on chatsworth.com, to simplify your planning, selection, order and purchase of CPI Cabinet & Aisle Containment Systems.

- Visio Shapes
- CAD Blocks
- BIM Drawings
- Cable Fill
- MasterFormat Specs
- OSHPD Products
- CPI Product Designer
- CPI Power Selector
- eConnect® Secure Array® Savings Estimator

Your Notes Here:



Cabinet Systems

CPI continuously provides flexibility in meeting the challenges of changing data and telecommunications technology. To meet these changes, CPI develops cabinets that are well-designed, forward-thinking and versatile.

The chart below lists the main style differences between CPI's cabinet families. Cabinets are available in several styles and sizes with a choice of included equipment mounting rails, side panels and doors.

When selecting a CPI Cabinet consider:

- Overall and usable width and depth
- Rack-mount units (U) required
- Aluminum or steel construction
- Style of equipment mounting rail (five to choose from)
- Door style (five styles including double doors)
- Cabinets are available without doors, sides or tops
- Color
- Fully or partially assembled

CPI Cabinet Comparison Chart

| Product | Key Attribute | Overall/Width (Rack-Mount) in (mm) | Material & Construction | Load Rating lb (kg) | Available Partially Assembled |
|---|--|--|---|---------------------------------------|-------------------------------|
| Zetaframe™ Cabinet System Page 1-4 | 80 industry standard sizes. Custom solutions available | 23.6 (600)/19" EIA 27.6 (700)/19" EIA 29.5 (750)/19" EIA 31.5 (800)/19" EIA | Roll-formed, tubular and welded steel | 5000 (2268) static 4000 lb dynamic | No |
| F-Series TeraFrame® Gen 3 Cabinet System Page 1-14 | Select from 561 standard frame sizes to exactly match site requirements. | 23.6 (600)/19" EIA 27.6 (700)/19" EIA 31.5 (800)/19" EIA | Steel and Aluminum, Welded and Bolted | 3000 (1360) 2500 (1134) | No |
| GF-Series GlobalFrame® Gen 2 Cabinet System Page 1-16 | Available in 60 industry standard sizes. | 23.6 (600)/19" EIA 27.6 (700)/19" EIA 29.5 (750)/19" EIA 31.5 (800)/19" EIA | Steel and Aluminum, Welded and Bolted | 3000 (1360) 2500 (1134) | No |
| N-Series TeraFrame® Network Cabinet Page 1-28 | Control side exhaust airflow from network and storage switches. | 31.5 (800)/19" EIA 40.0 (1016)/19" EIA | Steel and Aluminum, Welded and Bolted | 2500 (1134) | No |
| Z4-Series SeismicFrame Cabinet System Page 1-35 | Engineered to meet Zone 4 testing requirements in active seismic areas. | 23.6 (600)/19" EIA 31.5 (800)/19" EIA | Steel, Welded and Bolted | 1500 (680) | No |



For the full line of cabinet configurations, use the complete Product matrix or log on to the CPI Product Designer on our website at chatsworth.com. For additional assistance, contact Technical Support at 800-843-4969.



ZetaFrame Cabinet System

A highly engineered data center cabinet solution that delivers fast built-to-order configurability, industry-leading strength and scalability, regardless of the application. ZetaFrame Cabinet is a total, turnkey solution that integrates with power, cable and thermal management accessories to support next-generation compute.

ZetaFrame Cabinet features:

Speedy Deployment. Customer-specified, factory-assembled solution reduces component count, packaging and on-site assembly, saving time and delivery cost.

Fast Selection and Customization. Order a cabinet integrated with power, cable and thermal management preinstalled under a unique, project-specific part number

Future-Proof Strength. Roll-formed, tubular and fully welded steel frame architecture supports 5,000 lb (2268 kg) static and 4,000 lb (1814 kg) dynamic loads.

Integrated Bonding. Doors and panels automatically bond to the frame through door hinges and contact points, eliminating the need for attaching separate grounding straps to cabinet components.

Enhanced Cable Management. Simple and versatile cable management accessories can be used independently or in combinations to accommodate a wide variety of applications.

Integrated Airflow Management. Seamless integration with optional airflow management accessories ensures effective conditioned/exhaust air separation and maximum equipment cooling.

Cabinet Specifications:

- Available in 4 heights, 4 widths and 5 depths
- Roll-formed, tubular and fully welded steel four-post frame
- For indoor use only, in environmentally controlled areas
- (2) pairs of square-punched mounting rails bolt to frame. Front-to-back adjustable depth
- 19"W, EIA-310 Universal 5/8"-5/8"-1/2" (15.9 mm – 15.9 mm – 12.7 mm) vertical hole spacing
- Shock Pallet option meets requirements per the International Safe Transit Association (ISTA) 2B
- Load capacity:
 - 5000 lb (2268 kg), static load on leveling feet per UL 2416
 - 4000 lb (1814 kg), rolling load on casters per UL 2416 for depths of 1000 mm or greater
 - 4000 lb (1814 kg), shipping load on shock pallet

Frame Includes:

- Integrated track at the top of the frame supports attachment of cable pathway and airflow containment accessories
- Equipment mounting rails, (2) pairs
- Leveling feet and load-bearing casters
- Floor attachment brackets
- Baying kit
- PDU bracket, (1) pair, for mounting (2) vertical CPI PDUs side-by-side in one corner of the cabinet
- Equipment mounting hardware, (50) M6 Klik-Nut® cage nuts and screws
- T25 Torx Bit to secure ground block and other accessories to cabinet frame

Certifications:

- EIA-310-E compliant
- UL Listed 2416, NWIN, File #E227626

Use the part number configurator below to select a standard ZetaFrame Cabinet.

Choose the Height, Width, Depth, Panels, Thermal Configuration and Color. Example part number: **ZB45-A120A-E1**

Ships on Standard Pallet or Shock Pallet:

| | | | | | | | | | | | | |
|----------|----------|----------|----------|----------|----------|----------|----------|----------|----------|----------|----------|-----------|
| Z | 1 | 2 | 3 | - | 4 | 5 | 6 | 7 | 8 | - | 9 | 10 |
|----------|----------|----------|----------|----------|----------|----------|----------|----------|----------|----------|----------|-----------|

| 1. Height | | | |
|-----------|------|------|----------|
| U | in | mm | |
| 42 | 79.4 | 2017 | A |
| 45 | 84.6 | 2149 | B |
| 48 | 89.9 | 2283 | C |
| 52 | 96.9 | 2461 | D |

Height includes casters.

| 2. Width | | |
|----------|-----|----------|
| in | mm | |
| 23.6 | 600 | 1 |
| 27.6 | 700 | 2 |
| 29.5 | 750 | 3 |
| 31.5 | 800 | 4 |

| 3. Depth | | |
|----------|------|----------|
| in | mm | |
| 31.5 | 800 | 1 |
| 39.4 | 1000 | 2 |
| 41.3 | 1050 | 3 |
| 43.3 | 1100 | 4 |
| 47.2 | 1200 | 5 |

Frame depth does not include doors. See detailed dimensions

| 4. Doors | |
|--|----------|
| None | 0 |
| Single Perforated Front / Double Perforated Rear | A |
| No Front / Double Perforated Rear | B |

| 10. Shipping | |
|--------------|-----------------|
| 1 | Standard Pallet |
| 2 | Shock Pallet |

Shock Pallet is available for 42U, 45U, 48U cabinet heights and 43.3"D (1100 mm) and 47.2"D (1200 mm) cabinet depths.cabinets.

| 9. Color | |
|----------|---------------|
| 7 | Black |
| E | Glacier White |

| 8. Thermal Management | |
|-----------------------|----------------------------------|
| 0 | None |
| A | Air Dam |
| B | Air Dam, Brush-Sealed Front Rail |

Brush-Sealed Front Rails are not available for 23.6"W (600 mm) cabinets.

| 7. Bottom Panel | |
|-----------------|----------------|
| 0 | None |
| 1 | Grommet-Sealed |
| 2 | Brush-Sealed |

| 6. Side Panel | |
|---------------|---------|
| 0 | None |
| 1 | 1 Side |
| 2 | 2 Sides |

| 5. Top Panel | |
|--------------|----------------|
| 0 | None |
| 1 | Grommet-Sealed |
| 2 | Brush-Sealed |

Notes: All cabinets ship with two pairs of square-punched equipment mounting rails. Rails for 27.6"W (700 mm) and wider cabinets include four grommet-sealed cable openings (per rail). See detailed dimensions. Other sizes and configurations are available. Contact Technical support at techsupport@chatsworth.com for more information.



Configure It!

Take advantage of CPI's expertise and configure a complete solution, including eConnect® PDUs, RFID Electronic Locks and environmental sensors under a single part number. Custom solutions are also available through CPI's design engineering services. Email us at: techsupport@chatsworth.com

Use the part number configurator below to select a standard ZetaFrame Cabinet.
 Choose the Height, Width, Depth, Panels, Thermal Configuration and Color. Example part number: **ZB45-DB22B-71**

Vertical Exhaust Duct Configuration for Front-to-Top Airflow:

| | | | | | | | | | | | | |
|---|---|---|---|---|---|---|---|---|---|---|---|----|
| Z | 1 | 2 | 3 | - | 4 | 5 | 6 | 7 | 8 | - | 9 | 10 |
|---|---|---|---|---|---|---|---|---|---|---|---|----|

| 1. Height | | | |
|-----------|------|------|----------|
| U | in | mm | A |
| 42 | 79.4 | 2017 | A |
| 45 | 84.6 | 2149 | B |
| 48 | 89.9 | 2283 | C |
| 52 | 96.9 | 2461 | D |

Height includes casters.

| 2. Width | | | |
|----------|------|-----|----------|
| | in | mm | 1 |
| | 23.6 | 600 | 1 |
| | 27.6 | 700 | 2 |
| | 29.5 | 750 | 3 |
| | 31.5 | 800 | 4 |

| 3. Depth | | | |
|----------|------|------|----------|
| | in | mm | 3 |
| | 41.3 | 1050 | 3 |
| | 43.3 | 1100 | 4 |
| | 47.2 | 1200 | 5 |

Frame depth does not include doors. See detailed dimensions

| 4. Doors | | |
|---|--|----------|
| Single Perforated Front / Single Solid Rear | | D |
| No Front / Single Solid Rear | | E |

| 5. Top Panel | |
|--------------|--|
| A | 15-20" H (381 - 508 mm) Vertical Exhaust Duct |
| B | 20-34" H (508 - 863 mm) Vertical Exhaust Duct |
| C | 34-60" H (863 - 1524 mm) Vertical Exhaust Duct |
| D | 15-20" H (381 - 508 mm) Vertical Exhaust Duct, Air Director |
| E | 20-34" H (508 - 863 mm) Vertical Exhaust Duct, Air Director |
| F | 34-60" H (863 - 1524 mm) Vertical Exhaust Duct, Air Director |

A half brush seal is included at the lower rear of the duct.

| 10. Shipping | |
|--------------|-----------------|
| 1 | Standard Pallet |

| 9. Color | |
|----------|---------------|
| 7 | Black |
| E | Glacier White |

| 8. Thermal Management | |
|-----------------------|----------------------------------|
| A | Air Dam |
| B | Air Dam, Brush-Sealed Front Rail |

Brush-Sealed Front Rails are not available for 23.6"W (600 mm) cabinets.

| 7. Bottom Panel | |
|-----------------|----------------|
| 0 | None |
| 1 | Grommet-Sealed |
| 2 | Brush-Sealed |

| 6. Side Panel | |
|---------------|---------|
| 0 | None |
| 1 | 1 Side |
| 2 | 2 Sides |

At least one side panel between adjacent cabinets and bottom panel are recommended for optimal thermal performance.

Notes: All cabinets ship with two pairs of square-punched equipment mounting rails. Rails for 27.6"W (700 mm) and wider cabinets include four grommet-sealed cable openings (per rail). See detailed dimensions. Other sizes and configurations are available. Contact Technical support at techsupport@chatsworth.com for more information.



Configure It!

Take advantage of CPI's expertise and configure a complete solution, including eConnect® PDUs, RFID Electronic Locks and environmental sensors under a single part number. Custom solutions are also available through CPI's design engineering services. Email us at: techsupport@chatsworth.com

Dimension Tables:

Heights, Widths, Depths: See tables below for detailed dimensions.

| Height Dimensions - in (mm) | | | |
|-----------------------------|----------------------|-----------------------|---------------|
| Rack Mount Spaces (U) | Overall with Casters | Frame Only No Casters | Front Opening |
| 42 | 79.4 (2016) | 77.4 (1965) | 73.7 (1873) |
| 45 | 84.6 (2149) | 82.6 (2099) | 79.0 (2006) |
| 48 | 89.9 (2282) | 87.9 (2232) | 84.2 (2139) |
| 52 | 96.9 (2460) | 94.9 (2410) | 91.2 (2317) |

Casters add approximately 2" (51 mm) to frame and are factory-installed on the cabinet. Brush-sealed grommets in the top panel add approximately 3/8" (9 mm) to the height of the cabinet.

| Depth Dimensions - in (mm) | | | |
|----------------------------|--------------------|---------------------|--------------------|
| Nominal Depth | Overall with Doors | Frame Only No Doors | Maximum Rail Depth |
| 31.5 (800) | 34.6 (879) | 31.5 (800) | 28.5 (723) |
| 39.4 (1000) | 42.5 (1080) | 39.4 (1000) | 36.4 (923) |
| 41.3 (1050) | 44.4 (1128) | 41.3 (1050) | 38.3 (973) |
| 43.3 (1100) | 46.4 (1179) | 43.3 (1100) | 40.3 (1023) |
| 47.2 (1200) | 50.3 (1278) | 47.2 (1200) | 44.2 (1123) |

Front Door is approximately 1.6"D (41 mm) and Rear Door is approximately 1.5"D (38 mm). Minimum rail depth is 7" (178 mm), each rail is 3.5"D (89 mm). Rail depth is reduced when vertical accessories are placed in corners.

| Width Dimensions - in (mm) | | | |
|----------------------------|--------------------------|---------------|------------------------|
| Nominal Depth | Overall with Side Panels | Front Opening | Rack-Mount Panel Width |
| 23.6 (600) | 23.6 (600) | 19.9 (506) | 19 (482.6) |
| 27.6 (700) | 27.6 (700) | 23.9 (607) | 19 (482.6) |
| 29.5 (750) | 29.5 (750) | 25.8 (655) | 19 (482.6) |
| 31.5 (800) | 31.5 (800) | 27.8 (707) | 19 (482.6) |

Mounting Rail clearance is 17.8" (452 mm), mounting hole spacing is 18.3" (465 mm).

Installation Products

| Part Number | Description | Shipping Weight lb (kg) |
|-------------|---|-------------------------|
| 39150-001 | Leveling Feet Height Adjustment Tool, 5 mm Hex Ball Driver, 12"L (300 mm) | 1 (0.5) |
| 39207-701 | Ramp Kit for Shock Pallet Cabinets, Black | 26 (11.8) |
| 76543-001* | Clik-Nut Hardware Kit, Cage Nuts, Screws, M6, 25 Pack, Zinc | 1 (0.5) |

*Note: Baying Kits and Floor Mounting Brackets are included with each cabinet.
* Additional thread size and quantities available.*



Leveling Feet Height Adjustment Tool



Clik-Nut Hardware Kit

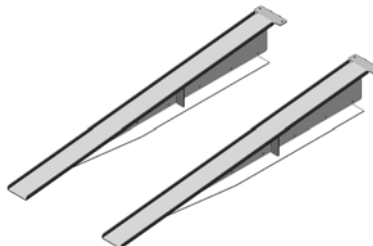

Ramp Kit for Shock Pallet Cabinets.

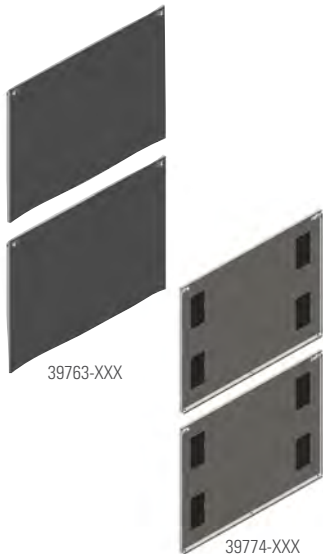

Side Panels

- Available in Solid or with Grommets
- Includes: Side panel (two halves, solid or with grommets), set of keys
- Two-piece design with top and bottom halves for easier handling
- Tool-less removal, drop-in design with integrated locking spring latch secures the side panel to the cabinet frame
- Features integral bonding, no bonding strap required
- Side Panel with Grommets feature multiple grommet-sealed cable openings, allowing cables to enter the side of the cabinet while containing exhaust air within each cabinet
- Side Panel with Grommets feature (8) cable openings per side, (4) per half-height panel, (1) per corner; Cable opening size without grommet is 4.5"W x 9"D (114 mm x 228 mm), sized for large power plugs
- Grommets are plastic, snap-on and can be cut to pass cables

| Part Number | | | | | Cabinet Frame Depth in (mm) | Shipping Weight lb (kg) | |
|-------------|---------|------------|------|------|-----------------------------|-------------------------|-----------|
| Solid | Grommet | Height (U) | | | | | |
| | | 42 | 45 | 48 | 52 | | |
| 39763 | 39774 | -X00 | -X51 | -XAC | -XDL | 31.5 (800) | 34 (15.5) |
| | | -X08 | -X59 | -XAL | -XDW | 39.4 (1000) | 41 (18.6) |
| | | -X10 | -X61 | -XAN | -XEA | 41.3 (1050) | 43 (19.1) |
| | | -X12 | -X63 | -XAR | -XEC | 43.3 (1100) | 45 (20.2) |
| | | -X16 | -X67 | -XAW | -XEG | 47.2 (1200) | 48 (21.7) |

Note: X=color: 7=Black, E=Glacier White. Shipping weights are for 52U configurations

Cable Port Brush Kits

- Use to replace grommets in top, bottom, or side panels
- Cable opening is 3.9"W x 8.8"D (99 mm x 224 mm)
- Configure with cabinet or available separately as an accessory.

| Part Number | Description | Shipping Weight lb (kg) |
|-------------|--|-------------------------|
| 25190-001 | Cable Port Brush Kit, Pack of 2, Black | 2 (0.9) |

Air Director

Air Director is an angled panel used at the back of cabinets for higher heat load applications with Vertical Exhaust Duct top panels to guide exhaust air toward the top of the cabinet. Configure with cabinet or available separately as an accessory

- Attaches to the bottom slide on the cabinet, adjusts in depth
- Select part number to match width and color of the cabinet
- Material: Steel
- Finish: Black or Glacier White

| Part Number | Description | Shipping Weight lb (kg) |
|-------------|------------------------------|-------------------------|
| 39802-X00 | For 23.6"W (600 mm) Cabinets | 12 (5.2) |
| 39802-X01 | For 27.6"W (700 mm) Cabinets | 13 (5.9) |
| 39802-X02 | For 29.5"W (750 mm) Cabinets | 14 (6.2) |
| 39802-X03 | For 31.5"W (800 mm) Cabinets | 15 (6.5) |

Note: X=color: 7=Black, E=Glacier White.

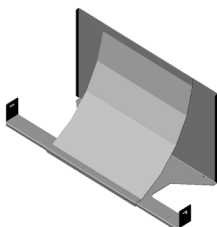



Air Dam Kit

Air Dam blocks airflow around the sides and top of the equipment mounting space, so conditioned air passes through equipment and exhaust air does not recirculate around equipment. Configure with cabinet or available separately as an accessory.

- Use with Equipment Mounting Rail Grommet Brush Kit and Bottom Panel
- Includes: Top, bottom and side baffles; installation hardware
- 600 mm attaches by wrapping around flange, 700, 750 & 800 mm attaches by snapping onto half lance
- Requires a minimum rail setback of 1.4" (36 mm) from the front of the cabinet frame; maximum rail setback is 13.7" (348 mm)
- Flexible seal against top and side panels
- Select part number to match the frame style, width, usable height and color
- Material: Steel, sheet metal, plastic seals
- Finish: Black or Glacier White; seals are black

| Part Number - Cabinet Width | | | | Height (U) | Shipping Weight lb (kg) |
|-----------------------------|-----------------|-----------------|-----------------|------------|-------------------------|
| 23.6"W (600 mm) | 27.6"W (700 mm) | 29.5"W (750 mm) | 31.5"W (800 mm) | | |
| 38649-X44 | 38649-X55 | 38649-X66 | 38649-X77 | 42 | 11 (5.0) |
| 38649-X47 | 38649-X58 | 38649-X69 | 38649-X80 | 45 | 11 (5.0) |
| 38649-X50 | 38649-X61 | 38649-X72 | 38649-X83 | 48 | 11 (5.0) |
| 38649-X54 | 38649-X65 | 38649-X76 | 38649-X87 | 52 | 12 (5.1) |

Note: X=color: 7=Black, E=Glacier White. Shipping weights are for 800 mm configurations



39731-XXX

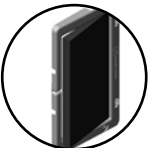

39716-XXX

Equipment Mounting Rail Grommet Kit

Set of (8) flexible plastic grommets that cover cable openings in the equipment mounting rails to block airflow around equipment. Configure with cabinet or available separately as an accessory.

- Grommets are plastic. Trim as needed to form seal around cables
- Not compatible with 23.6"W (600 mm) cabinet
- UL 94-V0 flammability rating

Equipment Mounting Rail Brush Kit

Set of (8) brush covers that conceal cable openings in the equipment mounting rails to block airflow around equipment. Configure with cabinet or available separately as an accessory.

- Allows for quick cable installation through mounting rails while maintaining a seal
- Suited for high cable density applications
- Split bezel design does not capture cables and allows for retrofitting around existing cables
- Not compatible with 23.6"W (600 mm) cabinets, UL 94-V0 flammability rating
- Material: Plastic housing, nylon brushes

| Part Number | Description | Shipping Weight lb (kg) |
|-------------|---|-------------------------|
| 39731-001 | Grommet Kit, for 27.6"W (700 mm) and 29.5"W (750 mm) Cabinets; Pack of 8; Black | 2 (0.9) |
| 39731-002 | Grommet Kit, for 31.5"W (800 mm) Cabinet; Pack of 8; Black | 2 (0.9) |
| 39716-001 | Brush Kit, for 27.6"W (700 mm) and 29.5"W (750 mm) Cabinets; Pack of 8; Black | 2 (0.9) |
| 39716-002 | Brush Kit, for 31.5"W (800 mm) Cabinet; Pack of 8; Black | 3 (1.4) |



Seal Kit Installation

Cabinet To Floor Seal Kits

Place at the bottom of cabinets to seal the space between the bottom of the cabinet and the floor when leveling feet or casters are in use. Ideal for aisle containment applications.

| Part Number | Description | Shipping Weight lb (kg) |
|---------------------------------------|------------------------------|-------------------------|
| Floor Seal Kit, Front and Rear | | |
| 39996-X00 | For 23.6"W (600 mm) Cabinet | 4.0 (1.8) |
| 39996-X01 | For 27.6"W (700 mm) Cabinet | 4.2 (1.9) |
| 39996-X02 | For 29.5"W (750 mm) Cabinet | 4.3 (2.0) |
| 39996-X03 | For 31.5"W (800 mm) Cabinet | 4.4 (2.0) |
| Floor Seal Kit, Sides | | |
| 39997-X00 | For 31.5"D (800 mm) Cabinet | 4.4 (2.0) |
| 39997-X08 | For 39.4"D (1000 mm) Cabinet | 5.8 (2.6) |
| 39997-X10 | For 41.3"D (1050 mm) Cabinet | 6.3 (2.9) |
| 39997-X12 | For 43.3"D (1100 mm) Cabinet | 6.9 (3.1) |
| 39997-X16 | For 47.2"D (1200 mm) Cabinet | 7.9 (3.6) |

Note: X=Color: 7=Black, E=Glacier White.



Snap-In Filler Panel

Snap-In Filler Panel blocks airflow in between equipment by sealing unused rack-mount spaces (U) in the cabinet. Use with Air Dam Kit and Bottom Panel to separate cold and hot air within the cabinet.

| Part Number | Description | Shipping Weight lb (kg) |
|-------------|--|-------------------------|
| 34537-X00 | Snap-In Filler Panel, 1U x 19"W (482.6 mm), Single | 14 (6.4) |
| 34537-X01 | Snap-In Filler Panel, 1U x 19"W (482.6 mm), 6 Pack | 14 (6.4) |
| 34538-X00 | Snap-In Filler Panel, 2U x 19"W (482.6 mm), Single | 21 (9.5) |
| 34538-X01 | Snap-In Filler Panel, 2U x 19"W (482.6 mm), 6 Pack | 21 (9.5) |

Note: X=Color: 0=Black, E=Glacier White.



4" Round Grommet

Raised Floor Grommets

Raised Floor Grommets provide a reliable seal around cable bundles. Split design allows for retrofitting over existing cable bundles in access floor tiles.

| Part Number | Description | Shipping Weight lb (kg) |
|-------------|---|-------------------------|
| 13671-001 | Floor Grommet, with Hardware, Single, Black | 2 (1.4) |
| 13671-002 | Floor Grommet, with Hardware, 10 Pack, Black | 18 (8.2) |
| 13874-001 | 4" (102 mm) Round Raised Floor Grommet, with Hardware, Single, Black | 1 (0.5) |
| 13874-002 | 4" (102 mm) Round Raised Floor Grommet, with Hardware, 10 Pack, Black | 6 (2.7) |

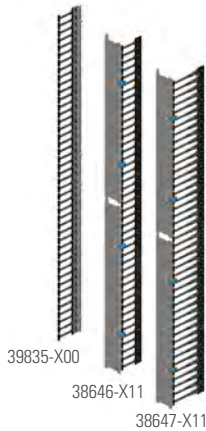

Vertical Cable Manager

- Fully compatible with Air Dam Kit and Cable Lashing Panel
- Openings between fingers align with each U on the mounting rail
- Short or long plastic T-shaped finger options
- Rail setback:
 - 7-1/4" (184 mm) for Managers with long fingers
 - 4-3/4" (121 mm) for Managers with short fingers
- Long fingers pass up to (48) cables per U space through openings
- Short fingers pass up to (24) cables per U space through openings
- Hinged cover included with managers in cabinets wider than 600 mm
- Material: aluminum panels, fingers are black, hinges/latches are blue
- Finish: Black or Glacier White; fingers and latches are plastic
- Select part number to match cabinet usable height, width and color cabinet

| Part Number - Cabinet Width | | | | Height (U) | Shipping Weight lb (kg) |
|--|-----------------|-----------------|-----------------|------------|-------------------------|
| 23.6"W (600 mm) | 27.6"W (700 mm) | 29.5"W (750 mm) | 31.5"W (800 mm) | | |
| Vertical Cable Manager with Long Fingers | | | | | |
| N/A | 38647-X11 | 38647-X22 | 38647-X33 | 42 | 9 (4.1) |
| N/A | 38647-X14 | 38647-X25 | 38647-X36 | 45 | 10 (4.5) |
| N/A | 38647-X17 | 38647-X28 | 38647-X39 | 48 | 10 (4.5) |
| N/A | 38647-X21 | 38647-X32 | 38647-X43 | 52 | 10 (4.5) |
| Vertical Cable Manager with Short Fingers | | | | | |
| 39835-X00 | 38646-X11 | 38646-X22 | 38646-X33 | 42 | 9 (4.1) |
| 39835-X03 | 38646-X14 | 38646-X25 | 38646-X36 | 45 | 10 (4.5) |
| 39835-X06 | 38646-X17 | 38646-X28 | 38646-X39 | 48 | 10 (4.5) |
| 39835-X10 | 38646-X21 | 38646-X32 | 38646-X43 | 52 | 10 (4.5) |

Note: X=Color: 7=Black, E=Glacier White. Shipping weights are for 800 mm configurations

| Inside Dimensions, Usable Internal Area, Rail Setback, U Opening | | | | | |
|--|---------------|---------------|---|----------------------|--|
| Cabinet Width | Width in (mm) | Depth in (mm) | Cable Area in ² (mm ²) | Rail Setback in (mm) | U Opening in ² (mm ²) |
| Vertical Cable Manager with Long Fingers | | | | | |
| 27.6 (700) | 2.2 (56) | 7.5 (191) | 17.0 (10 967) | 10.1 (257) | 6.6 (460) |
| 29.5 (750) | 3.2 (81) | 7.5 (191) | 24.5 (15 806) | 10.1 (257) | 6.6 (460) |
| 31.5 (800) | 4.2 (107) | 7.5 (191) | 31.9 (20 580) | 10.1 (257) | 6.6 (460) |
| Vertical Cable Manager with Short Fingers | | | | | |
| 23.6 (600) | 0.4 (10) | 5 (127) | 1.8 (1161) | 7.6 (193) | 3.5 (2260) |
| 27.6 (700) | 2.2 (56) | 5 (127) | 11.2 (7225) | 7.6 (193) | 3.5 (2260) |
| 29.5 (750) | 3.2 (81) | 5 (127) | 16.2 (10 451) | 7.6 (193) | 3.5 (2260) |
| 31.5 (800) | 4.2 (107) | 5 (127) | 21.2 (13 677) | 7.6 (193) | 3.5 (2260) |

Rail setback is the minimum distance required between the front edge of the cabinet frame and the front edge of the equipment mounting rail. U opening is the size of the side opening at each U space between T-shaped fingers.

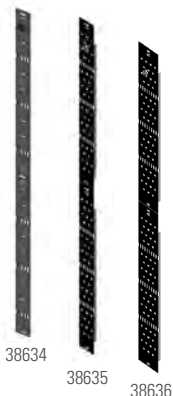

Cable Bundle Swivel, installed

Cable Lashing Panel

- Creates simple, vertical pathways for small cable bundles
- Attaches to cabinet frame, adjusts in depth independent of the mounting rails; Can be installed adjacent to Vertical Cable Manager
- Includes: Brackets, Cable Bundle Swivels and installation hardware
- Available in 3 widths: 2-3/4" W (70 mm), 4.5" W (115 mm) and 7" W (178 mm)
- 2-3/4" W (70 mm) includes (6) Cable Bundle Swivels, 4.5" W (115 mm) and 7" W (178 mm) include (12) Cable Bundle Swivels
- Patented Cable Bundle Swivels provide quick attachment, removal and adjustment of cable bundles
- Select part number per cabinet height and color
- Material: Steel; Cable Bundle Swivels are plastic
- Finish: Black or Glacier White; Cable Bundle Swivels are blue

| Part Number - Panel Width | | | Height (U) | Shipping Weight lb (kg) |
|---------------------------|---------------------------------|-----------------|------------|-------------------------|
| 2-3/4" (70 mm) | 4.5" W (115 mm) | 7.0" W (178 mm) | | |
| 38634-X00 | 38635-X00 | 38636-X00 | 42 | 13 (5.9) |
| 38634-X03 | 38635-X03 | 38636-X03 | 45 | 14 (6.4) |
| 38634-X06 | 38635-X06 | 38636-X06 | 48 | 15 (6.8) |
| 38634-X10 | 38635-X10 | 38636-X10 | 52 | 16 (7.3) |
| 32657-001 | Cable Bundle Swivel, Pack of 12 | | | 1 (0.5) |

Note: X=Color: 7=Black, E=Glacier White. Shipping weights are for 7" W (178 mm) Lashing Panels.

Front-to-Rear Cable Manager

Front-to-Rear Cable Manager attaches to the back of equipment mounting rails wherever there are cable openings, creating a cable pathway between front and rear rails.

- Hooks into front and rear mounting rails, and secures to cabinet frame using supplied hardware
- Adjustable to match various front-to-rear rail depths ranging from 20" (508 mm) to 32" (812 mm)
- Sold each, order to match cabinet width and color
- Material: Steel
- Finish: Black or Glacier White



| Part Number - Cabinet Width | | | | Rail Depth Range | Shipping Weight lb (kg) |
|-----------------------------|------------------|------------------|------------------|-------------------|-------------------------|
| 23.6" W (600 mm) | 27.6" W (700 mm) | 29.5" W (750 mm) | 31.5" W (800 mm) | | |
| N/A | 38648-X01 | 38648-X02 | 38648-X03 | 20-32 (508 - 812) | 7 (3.2) |

Note: X=Color: 7=Black, E=Glacier White. Shipping weight is for 800 mm configuration



Full Height PDU Bracket

- Available in Single or Dual options
- Order per PDU chassis width and PDU bracket capacity (1 or 2 PDUs)
- Bracket attaches to cabinet frame and is adjustable along the cabinet depth
- Use Dual bracket to mount (2) PDUs side-by-side or (1) PDU high outlet density 4" (102 mm) PDU chassis
- Tool-less mounting features at 12-1/4" increments up to 61-1/4" and 64-3/4"
- Select Brackets to match PDU width
- Consider a full height PDU bracket for cabinets 48U and taller for optimum PDU outlet placement

| Part Number - PDU Chassis Width | | | Cabinet Height (U) | PDU Bracket Capacity |
|---------------------------------|-----------------------|---------------|--------------------|----------------------|
| 2.2" (56 mm) | 2.4-2.7" (51 - 69 mm) | 4.0" (102 mm) | | |
| 38637-X00 | 38637-X11 | 38638-X00 | 42 | Single |
| 38637-X03 | 38637-X14 | 38638-X03 | 45 | Single |
| 38637-X06 | 38637-X17 | 38638-X06 | 48 | Single |
| 38637-X10 | 38637-X21 | 38638-X10 | 52 | Single |
| 38638-X00 | 38638-X11 | N/A | 42 | Double |
| 38638-X03 | 38638-X14 | N/A | 45 | Double |
| 38638-X06 | 38638-X17 | N/A | 48 | Double |
| 38638-X10 | 38638-X21 | N/A | 52 | Double |

Note: X=Color: 7=Black, E=Glacier White. Shipping weights are for Dual PDU Brackets



Standard PDU Bracket

- Includes (1) pair of brackets and installation hardware for use with CPI eConnect PDUs or vertical Power Strips. Configure with cabinet or available separately as an accessory.
- Supports (2) 2.7"W (69 mm) or narrower PDUs side-by-side or one PDU up to 4"W (101.6 mm)
- Attaches to the frame in either back corner
- Provides tool-less attachment points spaced 61-1/4" (1556 mm) apart on all cabinets
- Provides alternate tool-less attachment points spaced 64-3/4" (1645 mm) on cabinets 45U or taller

| Part Number | Description | Shipping Weight lb (kg) |
|-------------|----------------|-------------------------|
| 38645-700 | 2-Piece, Black | 2 (0.9) |



PATENTED
Vertical
Exhaust Duct

F-Series TeraFrame Gen 3 Cabinet System

The F-Series TeraFrame Gen 3 Cabinet System optimizes, stores and secures computer, data storage and network equipment in the data center, computer room or network environment. Every cabinet is available in a wide range of standard sizes and configurations to match your equipment and facility requirements.

The third generation F-Series TeraFrame features an enhanced frame design, new sizes and panels, easier equipment rail adjustment and smarter airflow management. A new six-slide frame style increases the cabinet's equipment load bearing capacity and is also available in a standard 52U height to maximize space. Side panels are half height, so they are easier to handle, and the cable openings in the top and bottom panels are wider to accommodate large power distribution unit (PDU) power plugs. Equipment mounting rails are now Z-shaped with a solid front surface, use no standoff brackets, adjust quickly using less hardware and help block bypass airflow around equipment. There are grommet-sealed cable openings in the rails in wider cabinets that allow a dedicated front-to-rear pathway for cabling, while blocking unwanted bypass airflow. Every cabinet also includes casters to ease placement, and leveling feet can be adjusted quickly using a ball hex driver.

Airflow management is an integral part of every cabinet, so brush seals cover all of the cable openings in the top and bottom panels. A new two-piece server top panel design provides an upgrade path to Vertical Exhaust Duct as thermal loads increase. When ordered with a duct, a bottom panel, airflow director and rear door seal are included with the cabinet to channel hot exhaust air to the duct. For best performance, use with the improved Air Dam and Snap-In Filler Panels to form a complete seal around the sides, top of the cabinet and in between rack-mount equipment.

Combine the F-Series TeraFrame with thermal and cable management accessories to create a solution that fits your exact needs.

Cabinet Specifications:

- Available in 11 heights, 3 widths and 17 depths
- Provides front and rear support for 19"W (482.6 mm) EIA rack-mount equipment and shelves
- Adjustable depth, rails slide front-to-back
- Marks on frame for easy vertical alignment
- 1-3/4"H (44.45 mm) U spacing, marked and numbered
- 19"W, EIA-310-E Universal vertical hole spacing
- Load capacity for 6-slide frame (per UL2416):
 - 3000 lb (1360 kg), static load on leveling feet
 - 2250 lb (1020 kg), rolling load on casters
- Load capacity for 4-slide frame (per UL2416):
 - 2500 lb (1134 kg), static load on leveling feet
 - 2000 lb (907.2 kg), rolling load on casters

Cabinet Includes:

- Welded steel and bolted aluminum four-post frame
- Equipment mounting rails, 2 pairs
- Equipment rail grommet kit
- Grounding/bonding system and ground lug
- Leveling feet and casters
- Floor attachment brackets
- Baying kit, for 600 mm or 24" spacing
- PDU brackets, 1 pair, for (2) 2.2"W (56 mm) vertical CPI PDUs
- Equipment mounting hardware, 50 M6 Click-Nut cage nuts and screws (square-punched rails)

Certifications:

- EIA-310-E compliant
- UL Listed 2416, NWIN, File #E227626

Use the part number configurator below to personalize your F-Series TeraFrame. Choose the **Height**, **Width**, **Depth**, **Rail Style**, **Front Door**, **Rear Door**, **Latch**, **Color**, **Top Panel Style**, **Side Panel Style** and **Frame Style**. **Example Cabinet Part Number: FC1U-113B-C42-B**

Complete Product Matrix:

The complete product matrix includes all options available. The Industry Standard Models that offer affordable pricing and shorter lead times are highlighted.

F H W D - R F R L - C T S - F

| 1. Height | | | |
|-----------|------|------|----------|
| U | in | mm | C |
| 42 | 79.4 | 2016 | C |
| 43 | 81.1 | 2060 | D |
| 44 | 82.9 | 2105 | E |
| 45 | 84.6 | 2149 | F |
| 46 | 86.4 | 2193 | G |
| 47 | 88.1 | 2238 | H |
| 48 | 89.9 | 2282 | J |
| 49 | 91.6 | 2327 | K |
| 50 | 93.4 | 2371 | L |
| 51 | 95.1 | 2416 | M |
| 52 | 96.9 | 2460 | N |

Height includes casters.

| 2. Width | | |
|----------|-----|----------|
| in | mm | C |
| 23.6 | 600 | 1 |
| 27.6 | 700 | 2 |
| 31.5 | 800 | 3 |

| 3. Depth | | |
|----------|------|----------|
| in | mm | C |
| 31.5 | 800 | A |
| 32.5 | 825 | B |
| 33.5 | 850 | C |
| 34.4 | 875 | D |
| 35.4 | 900 | E |
| 36.4 | 925 | F |
| 37.4 | 950 | G |
| 38.4 | 975 | H |
| 39.4 | 1000 | J |
| 40.4 | 1025 | K |
| 41.3 | 1050 | L |
| 42.3 | 1075 | M |
| 43.3 | 1100 | N |
| 44.3 | 1125 | P |
| 45.3 | 1150 | R |
| 46.3 | 1175 | T |
| 47.2 | 1200 | U |

Depth does not include doors. Front door adds 2.4" (61 mm) Rear door adds 1.5" (38 mm).

= Industry Standard

| 11. Frame Style | |
|-----------------|---------|
| A | 4-Slide |
| B | 6-Slide |

| 10. Side Panel Style | |
|----------------------|---------------|
| 0 | None |
| 1 | Solid, 1 each |
| 2 | Solid, 2 each |

| 9. Top Panel Style | |
|--------------------|---|
| 0 | None |
| 2 | Network, One-Piece, 4 Cable Openings |
| 4 | Server, Two-Piece, 4 Cable Openings |
| 5 | Vertical Exhaust Duct, 20"-34"H (508-863 mm) |
| 6 | Vertical Exhaust Duct, 34"-60"H (863-1523 mm) |

Options 4, 5, & 6 are for cabinets that are 41.3"D (1050 mm) or deeper. Use solid rear door with Vertical Exhaust Duct. Vertical Exhaust Duct includes Bottom Panel and Air Director.

| 8. Color | |
|----------|---------------|
| C | Black |
| E | Glacier White |

| 7. Latch/Locks Kits | |
|---------------------|--------------------------------------|
| B | Single-Point, Keyed Lock |
| C | Two-Point, Keyed Lock |
| D | Single-Point, Keyed/Combination Lock |
| E | Two-Point, Keyed/Combination Lock |
| N | None |

| 6. Rear Door | |
|--------------|--------------------------|
| 0 | None |
| 1 | Single, Solid Metal |
| 3 | Double, Perforated Metal |

Double Rear Door will include a two-point latch

| 5. Front Door | |
|---------------|--------------------|
| 0 | None |
| 1 | Single, Perforated |

| 4. Rail Style | |
|---------------|------------------------|
| 1 | Square-Punched, 2-Pair |



For the full line of cabinet configurations, use the complete Product matrix or log on to the CPI Product Designer on our website at chatsworth.com. For additional assistance, contact Technical Support at 800-843-4969.



PATENTED
Vertical
Exhaust Duct

GF-Series GlobalFrame Gen 2 Cabinet System

The GF-Series GlobalFrame Gen 2 Cabinet System is an industry-standard server and network equipment storage solution for data centers, computer rooms or network facilities.

Available in a select set of industry-standard sizes, GF-Series GlobalFrame features two specific configurations that meet most application requirements. Standard cabinets with perforated front and rear doors support front-to-rear airflow for hot aisle/cold aisle or aisle containment applications. High-density cabinets with perforated front and solid rear doors and a top-mount Vertical Exhaust Duct guide hot exhaust air away from the cabinet to support a closed return application. Both configurations cover the basics with adjustable depth Z-shaped mounting rails that help block bypass airflow around equipment. Cable openings in the top panels are large enough for high-amperage PDU power plugs, casters easily position the cabinet and locking doors and side panels secure equipment.

Additionally, CPI's second generation GF-Series GlobalFrame features new size and finish options, enhanced panels and doors, and smarter airflow management. The frame is now available in a standard 52U height, 700 mm width and 1100 mm depth to maximize space utilization, and a Glacier White finish that reflects more light. Maximum front-to-rear rail depths are increased to support deeper equipment. Top and bottom panels include snap-on plastic grommets to seal cable openings. Perforated areas on the doors are 78% open to maximize airflow, and the improved Air Dam accessory (ordered separately), which creates an airflow barrier around the rails to block bypass air inside the cabinet, allows rails to be adjusted to any depth.

Combine the GF-Series GlobalFrame with thermal and cable management accessories to create a solution that fits your exact needs.

Cabinet Specifications:

- Available in 4 heights, 4 widths and 5 depths
- Provides front and rear support for 19"W (482.6 mm) EIA rack-mount equipment and shelves
- Adjustable depth, rails slide front-to-back
- Marks on frame for easy vertical alignment
- 1-3/4"H (44.45 mm) U spacing, marked and numbered
- 19"W, EIA-310-E Universal vertical hole spacing
- Load capacity for 6-slide frame (per UL2416):
 - 3000 lb (1360 kg), static load on leveling feet
 - 2250 lb (1020 kg), rolling load on casters
 - 2000 lb (907.2 kg), shipping on shock pallet
- Load capacity for 4-slide frame (per UL2416):
 - 2500 lb (1134 kg), static load on leveling feet
 - 2000 lb (907.2 kg), rolling load on casters

Cabinet Includes:

- Welded steel and bolted aluminum four-post frame
- Equipment mounting rails, (2) pairs
- Grounding/bonding system and ground lug
- Leveling feet and casters
- Floor attachment brackets
- Baying kit, for 600 mm or 24" spacing
- PDU brackets, (1) pair, for (2) 2.2"W (56 mm) vertical CPI PDUs
- Equipment mounting hardware, 50 M6 Click-Nut cage nuts and screws (square-punched rails)

Certifications:

- EIA-310-E compliant
- UL Listed 2416, NWWIN, File #E227626

Use the part number configurator below to personalize your F-Series TeraFrame. Choose the **Height**, **Width**, **Depth**, **Rail Style**, **Front Door**, **Rear Door**, **Latch**, **Color**, **Top Panel Style**, **Side Panel Style** and **Frame Style**. **Example Cabinet Part Number: GF-1A100-CB**.

Complete Product Matrix:

The complete product matrix includes all options available.

| | | | | | | | | | |
|----|---|---|---|---|---|---|---|---|---|
| GF | - | H | W | D | S | C | - | C | F |
|----|---|---|---|---|---|---|---|---|---|

600 mm, 700 mm, 800mm Standard Cabinets

| GF- | 1. Height | | | 2. Width | | | 3. Depth | | | 4. Side Panels | | 5. Configuration | | 6. Color | | 7. Frame | |
|-----|-----------|------|------|----------|------|-----|----------|-------------|-------------|----------------|-------------|------------------|-------------------------------------|----------|---------------|----------|---------|
| | U | in | mm | in | mm | in | mm | Description | Description | Description | Description | | | | | | |
| 1 | 42 | 79.4 | 2016 | A | 23.6 | 600 | 1 | 31.5 | 800 | 0 | No Sides | 0 | Standard Top Panel/ Standard Pallet | C | Black | B | 6-Slide |
| 2 | 45 | 84.6 | 2149 | D | 27.6 | 700 | 2 | 39.4 | 1000 | 1 | One Side | | | E | Glacier White | A | 4-Slide |
| 3 | 48 | 89.9 | 2282 | C | 31.5 | 800 | 3 | 41.3 | 1050 | 2 | Two Sides | | | | | | |
| 4 | 52 | 96.9 | 2460 | | | | 5 | 43.3 | 1100 | | | | | | | | |
| | | | | | | | 4 | 47.2 | 1200 | | | | | | | | |

Notes: Height includes casters.

Frame depth does not include doors. Doors add approximately 4" (102 mm). See page 1-29 for detailed dimensions.

Includes Perforated Front and Rear Doors.

600 mm, 700 mm, 800mm Vertical Exhaust Duct Cabinets

| GF- | 1. Height | | | 2. Width | | | 3. Depth | | | 4. Side Panels | | 5. Configuration | | 6. Color | | 7. Frame | |
|-----|-----------|------|------|----------|------|-----|----------|-------------|-------------|----------------|-------------|------------------|---|----------|---------------|----------|---------|
| | U | in | mm | in | mm | in | mm | Description | Description | Description | Description | | | | | | |
| 1 | 42 | 79.4 | 2016 | A | 23.6 | 600 | 3 | 41.3 | 1050 | 0 | No Sides | 1 | Duct 20-34"H (508-863 mm)/ Standard Pallet | C | Black | B | 6-Slide |
| 2 | 45 | 84.6 | 2149 | D | 27.6 | 700 | 5 | 43.3 | 1100 | 1 | One Side | | | E | Glacier White | A | 4-Slide |
| 3 | 48 | 89.9 | 2282 | C | 31.5 | 800 | 4 | 47.2 | 1200 | 2 | Two Sides | | | | | | |
| 4 | 52 | 96.9 | 2460 | | | | | | | | | 2 | Duct 34-60"H (863-1523 mm)/ Standard Pallet | | | | |

Notes: Height includes casters. Height does not include Vertical Exhaust Duct. Frame depth does not include doors. Doors add approximately 4" (102 mm). See page 1-29 for detailed dimensions. Includes Perforated Front Door, Solid Rear Door, Vertical Exhaust Duct and Bottom Panel.

750 mm Standard and Vertical Exhaust Duct Cabinets

| GF- | 1. Height | | | 2. Width | | | 3. Depth | | | 4. Side Panels | | 5. Configuration | | 6. Color | | 7. Frame | |
|-----|-----------|------|------|----------|------|-----|----------|-------------|-------------|----------------|-------------|------------------|--|----------|---------------|----------|---------|
| | U | in | mm | in | mm | in | mm | Description | Description | Description | Description | | | | | | |
| 1 | 42 | 79.4 | 2016 | B | 29.5 | 750 | 3 | 41.3 | 1050 | 0 | No Sides | 0 | Standard Top Panel/ Standard Pallet | C | Black | B | 6-Slide |
| 2 | 45 | 84.6 | 2149 | | | | 5 | 43.3 | 1100 | 1 | One Side | | | E | Glacier White | | |
| 3 | 48 | 89.9 | 2282 | | | | 4 | 47.2 | 1200 | 2 | Two Sides | | | | | | |
| | | | | | | | | | | | | 1 | Duct 20-34"H (508-863 mm)/ Standard Pallet | | | | |
| | | | | | | | | | | | | 2 | Duct 34-60"H (863-1523 mm) Standard Pallet | | | | |

Notes: Height includes casters. Height does not include Vertical Exhaust Duct. Frame depth does not include doors. Doors add approximately 4" (102 mm). See page 1-29 for detailed dimensions. Includes Perforated Front Door, Solid Rear Door, Vertical Exhaust Duct and Bottom Panel.

600 mm, 700 mm, 750 mm & 800 mm Shock Pallet Combinations

| GF- | 1. Height | | | 2. Width | | | 3. Depth | | | 4. Side Panels | | 5. Configuration | | 6. Color | | 7. Frame | |
|-----|-----------|------|------|----------|------|-----|----------|-------------|-------------|----------------|-------------|------------------|----------------------------------|----------|---------------|----------|---------|
| | U | in | mm | in | mm | in | mm | Description | Description | Description | Description | | | | | | |
| 1 | 42 | 79.4 | 2016 | A | 23.6 | 600 | 3 | 41.3 | 1050 | 0 | No Sides | 3 | Standard Top Panel/ Shock Pallet | C | Black | B | 6-Slide |
| 2 | 45 | 84.6 | 2149 | D | 27.6 | 700 | 5 | 43.3 | 1100 | 1 | One Side | | | E | Glacier White | | |
| | | | | B | 29.5 | 750 | 4 | 47.2 | 1200 | 2 | Two Sides | | | | | | |
| | | | | C | 31.5 | 800 | | | | | | | | | | | |

Notes: Height includes casters. Frame depth does not include doors. Doors add approximately 4" (102 mm). See page 1-29 for detailed dimensions. Includes Perforated Front and Rear Doors. Reusable Packaging.

Specifications/Ordering Notes:

1. Heights, Widths, Depths: See tables below for detailed dimensions.

| Height Dimensions - in (mm) | | | |
|-----------------------------|----------------------|-----------------------|---------------|
| Rack Mount Spaces (U) | Overall with Casters | Frame Only No Casters | Front Opening |
| 42 | 79.4 (2016) | 77.4 (1965) | 73.9 (1876) |
| 43 | 81.1 (2060) | 79.1 (2010) | 75.6 (1921) |
| 44 | 82.9 (2105) | 80.9 (2054) | 77.4 (1965) |
| 45 | 84.6 (2149) | 82.6 (2099) | 79.1 (2010) |
| 46 | 86.4 (2193) | 84.4 (2143) | 80.9 (2054) |
| 47 | 88.1 (2238) | 86.1 (2187) | 82.6 (2099) |
| 48 | 89.9 (2282) | 87.9 (2232) | 84.4 (2143) |
| 49 | 91.6 (2327) | 89.6 (2276) | 86.1 (2187) |
| 50 | 93.4 (2371) | 91.4 (2321) | 87.9 (2232) |
| 51 | 95.1 (2416) | 93.1 (2365) | 89.6 (2276) |
| 52 | 96.9 (2460) | 94.9 (2410) | 91.4 (2321) |

Castors add approximately 2" (51 mm) to frame and are factory installed on the cabinet.

| Width Dimensions - in (mm) | | | |
|----------------------------|--------------------------|---------------|------------------------|
| Nominal Depth | Overall with Side Panels | Front Opening | Rack-Mount Panel Width |
| 600 | 23.6 (600) | 19.6 (498) | 19 (482.6) |
| 700 | 27.6 (700) | 23.5 (598) | 19 (482.6) |
| 800 | 31.5 (800) | 27.5 (698) | 19 (482.6) |

Mounting Rail clearance is 17.8" (452 mm). Mounting hole spacing is 18.3" (465 mm).

| Depth Dimensions - in (mm) | | | |
|----------------------------|--------------------|---------------------|--------------------|
| Nominal Depth | Overall with Doors | Frame Only No Doors | Maximum Rail Depth |
| 800 | 35.4 (900) | 31.5 (800) | 29.3 (745) |
| 825 | 36.4 (925) | 32.5 (825) | 30.3 (770) |
| 850 | 37.4 (950) | 33.5 (850) | 31.3 (795) |
| 875 | 38.4 (975) | 34.4 (875) | 32.3 (820) |
| 900 | 39.4 (1000) | 35.4 (900) | 33.2 (843) |
| 925 | 40.4 (1025) | 36.4 (925) | 34.2 (870) |
| 950 | 41.4 (1050) | 37.4 (950) | 35.2 (895) |
| 975 | 42.3 (1075) | 38.4 (975) | 36.2 (920) |
| 1000 | 43.3 (1100) | 39.4 (1000) | 37.2 (945) |
| 1025 | 44.3 (1125) | 40.4 (1025) | 38.2 (970) |
| 1050 | 45.3 (1150) | 41.3 (1050) | 39.2 (995) |
| 1075 | 46.3 (1175) | 42.3 (1075) | 40.1 (1020) |
| 1100 | 47.3 (1200) | 43.3 (1100) | 41.1 (1045) |
| 1125 | 48.2 (1225) | 44.3 (1125) | 42.1 (1070) |
| 1150 | 49.2 (1250) | 45.3 (1150) | 43.1 (1095) |
| 1175 | 50.2 (1275) | 46.3 (1175) | 44.1 (1120) |
| 1200 | 51.2 (1300) | 47.2 (1200) | 45.1 (1145) |

Front Door is approximately 2.4"D (61 mm), and Rear Door is approximately 1.5"D (38 mm) with hinges/latches. Minimum rail depth is 7" (178 mm), and each rail is 3.5"D (89 mm). Rail depth is reduced when vertical accessories are placed in corners.

- Use the perforated doors with Aisle Containment Solutions or traditional hot aisle/cold aisle applications. Use the solid rear door with Vertical Exhaust Duct top panels.
- Select a single-point or two-point latch and a keyed or combination lock. Double doors require a two-point latch. If you select a single-point latch and a double rear door, the front door will have a single-point latch, and the rear door will have a two-point latch. All doors must have a latch. The (N) option should only be selected if the cabinet has NO doors. Doors have a swing handle on the exterior. The combination lock uses a three-digit combination entered on three-dials that are integrated into the swing handle or a key. The combination lock can be reprogrammed in the field.
- There are three styles of top panel. Network top panels are a one-piece panel with four brush-sealed cable openings, one per corner. Server top panels are for cabinets that are 1050 mm deep or deeper that may be upgraded with Vertical Exhaust Duct at a future date. Server top panels are two-piece panels with four brush-sealed cable openings, one per corner. The rear piece of the panel is removed to add a Vertical Exhaust Duct. Vertical Exhaust Duct top panels have two brush-sealed cable openings in the front corners, and the duct at the rear of the cabinet. Choose the duct height range that fits the distance between the top of the cabinet and the drop ceiling. Cabinets with Vertical Exhaust Duct top panels include a bottom panel and airflow director, and must be used with a solid rear door.



For the full line of cabinet configurations, use the complete Product matrix or log on to the CPI Product Designer on our website at chatsworth.com. For additional assistance, contact Technical Support at 800-843-4969.



eConnect® RFID Electronic Lock Kit

Integrate cabinet access control along with power management and environmental monitoring under a single network connection, one user interface and one user database for dramatically reduced deploymentsavings. Fully compatible with DCIM software. Available on vertical Monitored, Monitored Pro, Switched and Switched Pro eConnect PDUs.

| Part Number | Description | Shipping Weight lb (kg) |
|-------------|--|-------------------------|
| 14666-001 | eConnect® RFID Electronic Lock Kit For GlobalFrame and TeraFrame cabinet systems | 3 (1.4) |



USB Temperature and Humidity Sensor

Attaches to the USB port in the PDUs.

| Part Number | Description | Shipping Weight lb (kg) |
|-------------|-------------------------------------|-------------------------|
| 14665-001 | USB Temperature and Humidity Sensor | 3 (1.4) |



Simplify ordering, shipping and installation by requesting eConnect PDUs and eConnect RFID Electronic Lock Kit to be installed in CPI's GF-Series GlobalFrame or F-Series TeraFrame cabinets before they leave the factory. Request Redundancy Pack for easy identification of primary and secondary units.

Add power. Make it easy.

Full Height PDU Brackets, Dual and Wide Widths

Full Height PDU Bracket supports two vertical PDUs side-by-side and has multiple slots for CPI Saf-T-Grip® Straps or tie wraps to secure cords to the bracket. Two sizes available, Dual and Wide.

- Attaches to the frame, adjusts in depth independent of the mounting rails
- Dual is 4.8"W (121 mm) and supports (2) 2.2"W (56 mm) PDUs side-by-side
- Wide is 5.8"W (147 mm) and supports (2) 2.7"W (69 mm) PDUs side-by-side.
Use wide for all 6-breaker PDUs and International Power Strips
- Tool-less mounting on 61.25" (1556 mm) or 64.75" (1645 mm) centers



| Part Number | | Height (U) | Shipping Weight lb (kg) |
|-------------|-----------|------------|-------------------------|
| Dual | Wide | | |
| 39086-X00 | 39221-X00 | 42 | 9 (4.1) |
| 39086-X01 | 39221-X01 | 43 | 9 (4.1) |
| 39086-X02 | 39221-X02 | 44 | 9 (4.1) |
| 39086-X03 | 39221-X03 | 45 | 10 (4.5) |
| 39086-X04 | 39221-X04 | 46 | 10 (4.5) |
| 39086-X05 | 39221-X05 | 47 | 10 (4.5) |
| 39086-X06 | 39221-X06 | 48 | 10 (4.5) |
| 39086-X07 | 39221-X07 | 49 | 11 (5.0) |
| 39086-X08 | 39221-X08 | 50 | 11 (5.0) |
| 39086-X09 | 39221-X09 | 51 | 11 (5.0) |
| 39086-X10 | 39221-X10 | 52 | 11 (5.0) |

X=color: C=Black, E=Glacier White.

Cable Lashing Bracket

Cable Lashing Bracket creates a simple, separate vertical pathway for a small bundle of cables and has multiple slots for CPI Saf-T-Grip® Straps or tie wraps to secure cables to the bracket.

- Attaches to the frame, adjusts in depth independent of the mounting rails
- Bracket is 1.6"W (41 mm), order Saf-T-Grips or cable ties separately



| Part Number - Frame Style | | Height (U) | Shipping Weight lb (kg) |
|---------------------------|-----------|------------|-------------------------|
| 6-Slide | 4-Slide | | |
| 39124-X00 | 39131-X00 | 42 | 4 (1.8) |
| 39124-X01 | 39131-X01 | 43 | 4 (1.8) |
| 39124-X02 | 39131-X02 | 44 | 4 (1.8) |
| 39124-X03 | 39131-X03 | 45 | 5 (2.3) |
| 39124-X04 | 39131-X04 | 46 | 5 (2.3) |
| 39124-X05 | 39131-X05 | 47 | 5 (2.3) |
| 39124-X06 | 39131-X06 | 48 | 5 (2.3) |
| 39124-X07 | 39131-X07 | 49 | 5 (2.3) |
| 39124-X08 | 39131-X08 | 50 | 5 (2.3) |
| 39124-X09 | 39131-X09 | 51 | 5 (2.3) |
| 39124-X10 | 39131-X10 | 52 | 5 (2.3) |

X=color: C=Black, E=Glacier White.

Finger Cable Manager

Finger Cable Manager attaches to the equipment mounting rail, creating a pathway for cables next to the rail and includes plastic T-shaped cable guides (fingers) that organize cables by rack-mount space (U).

- Attaches to and adjusts with mounting rails, fully compatible with Air Dam
- Plastic, T-shaped cable guides organize cables by rack-mount space (U)
- Openings between cable guides (fingers) align with each rack-mount space on the mounting rail
- Pass up to 48 cables per U space through openings on the Finger Cable Manager. Pass up to 24 cables per U space through openings on the Short Finger Cable Manager
- Hinged cover included with managers in wider cabinets, cover snaps closed to secure cables
- Includes: finger cable manager, cover (wider cabinets only), installation hardware. Material: Steel panels, plastic guides and latches
- Select part number to match the width, usable height and color of the cabinet



| Inside Dimensions, Usable Internal Cable Area, Rail Setback | | | | |
|---|---------------|---------------|---|----------------------|
| Cabinet Width | Width in (mm) | Depth in (mm) | Cable Area in ² (mm ²) | Rail Setback in (mm) |
| Finger Cable Manager | | | | |
| 27.6 (700) | 2.6 (66) | 8.4 (213) | 21.8 (14 060) | 10.1 (257) |
| 29.5 (750) | 3.7 (94) | 8.4 (213) | 31.0 (20 000) | 10.1 (257) |
| 31.5 (800) | 4.6 (117) | 8.4 (213) | 38.6 (24 900) | 10.1 (257) |
| Finger Cable Manager, Short | | | | |
| 23.6 (600) | .5 (13) | 6.0 (150) | 3 (1900) | 7.6 (193) |
| 27.6 (700) | 2.6 (66) | 6.0 (150) | 15.6 (10 060) | 7.6 (193) |
| 29.5 (750) | 3.7 (94) | 6.0 (150) | 21.6 (13 940) | 7.6 (193) |
| 31.5 (800) | 4.6 (117) | 6.0 (150) | 27.8 (17 940) | 7.6 (193) |

Rail setback is the minimum distance required between the front edge of the cabinet frame and the front edge of the equipment mounting rail.

| Part Number – Cabinet Width | | | | Height in (mm) | Shipping Weight lb (kg) |
|-----------------------------|------------------|------------------|------------------|----------------|-------------------------|
| 23.6" W (600 mm) | 27.6" W (700 mm) | 29.5" W (750 mm) | 31.5" W (800 mm) | | |
| Finger Cable Manager | | | | | |
| N/A | 39112-X11 | 39112-X33 | 39112-X22 | 42 | 22 (10.0) |
| N/A | 39112-X12 | N/A | 39112-X23 | 43 | 22 (10.0) |
| N/A | 39112-X13 | N/A | 39112-X24 | 44 | 22 (10.0) |
| N/A | 39112-X14 | 39112-X36 | 39112-X25 | 45 | 23 (10.4) |
| N/A | 39112-X15 | N/A | 39112-X26 | 46 | 23 (10.4) |
| N/A | 39112-X16 | N/A | 39112-X27 | 47 | 23 (10.4) |
| N/A | 39112-X17 | 39112-X39 | 39112-X28 | 48 | 25 (11.3) |
| N/A | 39112-X18 | N/A | 39112-X29 | 49 | 25 (11.3) |
| N/A | 39112-X19 | N/A | 39112-X30 | 50 | 25 (11.3) |
| N/A | 39112-X20 | N/A | 39112-X31 | 51 | 26 (11.8) |
| N/A | 39112-X21 | N/A | 39112-X32 | 52 | 26 (11.8) |
| Finger Cable Manager, Short | | | | | |
| 39120-X00 | 39235-X11 | 39235-X33 | 39235-X22 | 42 | 21 (9.5) |
| 39120-X01 | 39235-X12 | N/A | 39235-X23 | 43 | 21 (9.5) |
| 39120-X02 | 39235-X13 | N/A | 39235-X24 | 44 | 21 (9.5) |
| 39120-X03 | 39235-X14 | 39235-X36 | 39235-X25 | 45 | 22 (10.0) |
| 39120-X04 | 39235-X15 | N/A | 39235-X26 | 46 | 22 (10.0) |
| 39120-X05 | 39235-X16 | N/A | 39235-X27 | 47 | 22 (10.0) |
| 39120-X06 | 39235-X17 | 39235-X39 | 39235-X28 | 48 | 23 (10.4) |
| 39120-X07 | 39235-X18 | N/A | 39235-X29 | 49 | 23 (10.4) |
| 39120-X08 | 39235-X19 | N/A | 39235-X30 | 50 | 23 (10.4) |
| 39120-X09 | 39235-X20 | N/A | 39235-X31 | 51 | 24 (10.9) |
| 39120-X10 | 39235-X21 | N/A | 39235-X32 | 52 | 24 (10.9) |

X=Color: C=Black, E=Glacier White. Shipping Weights are for 800 mm kits.

Ring Cable Manager

Ring Cable Manager is independent of the equipment mounting rails, creating a separate vertical pathway for cables and includes plastic cable rings to organize cables.

- Attaches to the frame, adjusts in depth independent of the mounting rails
- Rings have an opening on the front for easy addition or removal of cables
- Includes: brackets, rings, installation hardware



| Part Number - Cabinet Width For 6-Slide Frame Style | | | | Height in (mm) | Shipping Weight lb (kg) |
|--|--------------------|--------------------|--------------------|-------------------|-------------------------------|
| 23.6"W (600 mm) | 27.6"W (700 mm) | 29.5"W (750 mm) | 31.5"W (800 mm) | | |
| 39087-X00 | 39088-X00 | 39088-X00 | 39089-X00 | 42 | 13 (5.9) |
| 39087-X01 | 39088-X01 | N/A | 39089-X01 | 43 | 13 (5.9) |
| 39087-X02 | 39088-X02 | N/A | 39089-X02 | 44 | 13 (5.9) |
| 39087-X03 | 39088-X03 | 39088-X03 | 39089-X03 | 45 | 14 (6.4) |
| 39087-X04 | 39088-X04 | N/A | 39089-X04 | 46 | 14 (6.4) |
| 39087-X05 | 39088-X05 | N/A | 39089-X05 | 47 | 14 (6.4) |
| 39087-X06 | 39088-X06 | 39088-X06 | 39089-X06 | 48 | 14 (6.4) |
| 39087-X07 | 39088-X07 | N/A | 39089-X07 | 49 | 14 (6.4) |
| 39087-X08 | 39088-X08 | N/A | 39089-X08 | 50 | 15 (6.8) |
| 39087-X09 | 39088-X09 | N/A | 39089-X09 | 51 | 15 (6.8) |
| 39087-X10 | 39088-X10 | 39088-X10 | 39089-X10 | 52 | 15 (6.8) |
| Part Number - Cabinet Width For 4-Slide Frame Style | | | | Height in (mm) | Shipping Weight lb (kg) |
| 23.6"W (600 mm) | 27.6"W (700 mm) | 31.5"W (800 mm) | | | |
| 39127-X00 | 39128-X00 | 39129-X00 | | 42 | 14 (6.4) |
| 39127-X01 | 39128-X01 | 39129-X01 | | 43 | 14 (6.4) |
| 39127-X02 | 39128-X02 | 39129-X02 | | 44 | 14 (6.4) |
| 39127-X03 | 39128-X03 | 39129-X03 | | 45 | 14 (6.4) |
| 39127-X04 | 39128-X04 | 39129-X04 | | 46 | 14 (6.4) |
| 39127-X05 | 39128-X05 | 39129-X05 | | 47 | 15 (6.8) |
| 39127-X06 | 39128-X06 | 39129-X06 | | 48 | 15 (6.8) |
| 39127-X07 | 39128-X07 | 39129-X07 | | 49 | 15 (6.8) |
| 39127-X08 | 39128-X08 | 39129-X08 | | 50 | 15 (6.8) |
| 39127-X09 | 39128-X09 | 39129-X09 | | 51 | 15 (6.8) |
| 39127-X10 | 39128-X10 | 39129-X10 | | 52 | 15 (6.8) |

Ring Manager Rail Setback Table below.

Note: Rail setback is the minimum distance required between the front edge of the cabinet frame and the front edge of the equipment mounting rail.

X=color: C=Black, E=Glacier White. Shipping Weights are for 800 mm kits.

| Inside Dimensions, Usable Internal Cable Area, Rail Setback | | | | | |
|---|---------------|---------------|---|------------------------------|------------------------------|
| Cabin Width | Width in (mm) | Depth in (mm) | Cable Area in ² (mm ²) | Rail Setback in (mm) 6-Slide | Rail Setback in (mm) 4-Slide |
| 23.6 (600) | .9 (29) | 3.3 (84) | 2.9 (1870) | 7.6 (193) | 9.1 (231) |
| 27.6 (700) | 2.3 (58) | 5.5 (140) | 12.6 (8130) | 8.2 (208) | 8.2 (208) |
| 29.5 (750) | 2.3 (58) | 5.5 (140) | 12.6 (8130) | 8.2 (208) | 8.2 (208) |
| 31.5 (800) | 4.2 (107) | 3.5 (89) | 14.7 (9480) | 6.4 (163) | 6.4 (163) |

PATENTED

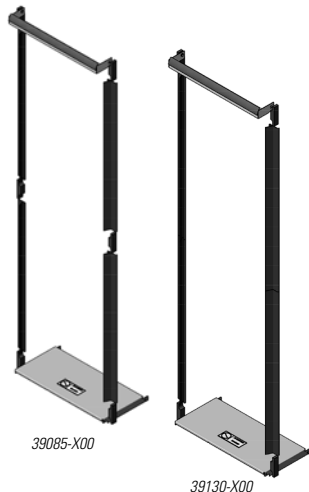

Air Dam Kit

Blocks airflow around the top and sides of equipment. Requires a minimum rail setback of 1.3" (33 mm) from the front of the cabinet frame. Compatible with Bottom Panel. Use with Snap-In Filler Panels.

| Part Number - Cabinet Width For 6-Slide Frame Style | | | | Height (U) | Shipping Weight lb (kg) |
|--|--------------------|--------------------|--------------------|------------|----------------------------|
| 23.6"W (600 mm) | 27.6"W (700 mm) | 29.5"W (750 mm) | 31.5"W (800 mm) | | |
| 39085-X00 | 39085-X11 | 39085-X33 | 39085-X22 | 42 | 11 (5.0) |
| 39085-X01 | 39085-X12 | N/A | 39085-X23 | 43 | 11 (5.0) |
| 39085-X02 | 39085-X13 | N/A | 39085-X24 | 44 | 11 (5.0) |
| 39085-X03 | 39085-X14 | 39085-X36 | 39085-X25 | 45 | 11 (5.0) |
| 39085-X04 | 39085-X15 | N/A | 39085-X26 | 46 | 12 (5.4) |
| 39085-X05 | 39085-X16 | N/A | 39085-X27 | 47 | 12 (5.4) |
| 39085-X06 | 39085-X17 | 39085-X39 | 39085-X28 | 48 | 12 (5.4) |
| 39085-X07 | 39085-X18 | N/A | 39085-X29 | 49 | 12 (5.4) |
| 39085-X08 | 39085-X19 | N/A | 39085-X30 | 50 | 12 (5.4) |
| 39085-X09 | 39085-X20 | N/A | 39085-X31 | 51 | 12 (5.4) |
| 39085-X10 | 39085-X21 | N/A | 39085-X32 | 52 | 13 (5.9) |

| Part Number - Cabinet Width For 4-Slide Frame Style | | | Height (U) | Shipping Weight lb (kg) |
|--|--------------------|--------------------|------------|----------------------------|
| 23.6"W (600 mm) | 27.6"W (700 mm) | 31.5"W (800 mm) | | |
| 39130-X00 | 39130-X11 | 39130-X22 | 42 | 11 (5.0) |
| 39130-X01 | 39130-X12 | 39130-X23 | 43 | 11 (5.0) |
| 39130-X02 | 39130-X13 | 39130-X24 | 44 | 11 (5.0) |
| 39130-X03 | 39130-X14 | 39130-X25 | 45 | 12 (5.4) |
| 39130-X04 | 39130-X15 | 39130-X26 | 46 | 12 (5.4) |
| 39130-X05 | 39130-X16 | 39130-X27 | 47 | 12 (5.4) |
| 39130-X06 | 39130-X17 | 39130-X28 | 48 | 12 (5.4) |
| 39130-X07 | 39130-X18 | 39130-X29 | 49 | 12 (5.4) |
| 39130-X08 | 39130-X19 | 39130-X30 | 50 | 13 (5.9) |
| 39130-X09 | 39130-X20 | 39130-X31 | 51 | 13 (5.9) |
| 39130-X10 | 39130-X21 | 39130-X32 | 52 | 13 (5.9) |

X=Color; C=Black; E=Glacier White. Shipping Weights are 800 mm kits.



Snap-In Filler Panel

Snap-In Filler Panel blocks airflow in between equipment by sealing unused rack-mount spaces (U) in the cabinet. Use with Air Dam Kit and Bottom Panel to separate cold and hot air within the cabinet.

| Part Number | | | Height (U) | Shipping Weight lb (kg) |
|-------------|-----------|-----------|------------|----------------------------|
| Each (1) | Each (6) | Each (50) | | |
| 34537-X00 | 34537-X01 | 34537-X02 | 1U | 14 (6.4) |
| 34538-X00 | 34538-X01 | 34538-X02 | 2U | 21 (9.5) |

X=Color; O=Black; E=Glacier White. Shipping Weights are for 50 pack.

PATENTED

Vertical Exhaust Duct



Vertical Exhaust Duct

Vertical Exhaust Duct attaches to the top of the cabinet to provide a sealed pathway for hot air from the top of the cabinet to an overhead drop ceiling as part of a closed hot air return.

- Used with Solid Rear Door, Bottom Panel, Air Dam, Snap-In Filler Panels and Air Director to completely contain hot exhaust air and remove it from the cabinet and room
- Fits cabinets that are 41.3"D (1050 mm) or deeper that have a 2-piece Server top panel
- 2-piece duct adjusts in height to span the distance between the top of the cabinet and the overhead drop ceiling, available in three sizes (see description in order table)
- Features easy height adjustment, has a flexible seal at the top to accommodate variations in the drop ceiling
- Includes a brush-sealed opening on the back for power cords
- U.S. patents apply to this product. For details visit: chatsworth.com/patents

| Part Number Cabinet Width | | | Description in (mm) | Shipping Weight lb (kg) |
|------------------------------|--------------------|--------------------|------------------------|-------------------------------|
| 23.6"W (600 mm) | 27.6"W (700 mm) | 31.5"W (800 mm) | | |
| 39177-X00 | 39177-X03 | 39177-X06 | 14-20 (356-508) | 17 (7.7) |
| 39177-X01 | 39177-X04 | 39177-X07 | 20-34 (508-863) | 25 (11.3) |
| 39177-X02 | 39177-X05 | 39177-X08 | 34-60 (863-1523) | 43 (19.5) |

X=Color; 7=Black; E=Glacier White. Shipping Weights are 800 mm ducts.

Bottom Panel

Bottom Panel seals the bottom of the cabinet to contain and control airflow in cabinets that are elevated on casters or leveling feet.

- Solid panel with 2 brush-sealed cable openings
- 2-piece design for easy installation, adjusts in depth to fit cabinet
- Cable openings are 4.5"W x 9"D (114 mm x 228 mm) without cover,
- Brush covers over cable openings, protects cables as they pass through bottom panel, provides a 3.9"W x 8.8"D (99 mm x 223 mm) pass through area for cables
- Brush cover is 2 halves that snap together around cables and forms a seal
- Fits cabinet frames that are 39.4"D (1000 mm) and deeper

| Bottom Panel Part Number - Cabinet Width | | | Description in (mm) | Shipping Weight lb (kg) |
|---|--------------------|--------------------|------------------------|-------------------------------|
| 23.6"W (600 mm) | 27.6"W (700 mm) | 31.5"W (800 mm) | | |
| 39132-X00 | 39132-X01 | 39132-X02 | ≥39.4 (1000) | 30 (13.6) |

X=Color; C=Black; E=Glacier White. Shipping Weights are 800 mm kits.





Side Panel with Brush Seal Openings

Side Panel with Brush Seal Openings features multiple brush-sealed cable openings that allow cables to enter the side of the cabinet, while containing exhaust air within each cabinet.

- 2-piece design with top and bottom halves for easier handling
- 8 cable openings per side, 4 per half-height panel, 1 per corner, are 4.5"W x 9"D (114 mm x 228 mm) without cover, sized for large power plugs
- Brush cover over cable openings protects cables as they pass through the side panel and provides a 3.9"W x 8.8"D (99 mm x 223 mm) pass through area for cables
- Tool-less removal, drop in design with integrated locking spring latch secures the side panel to the cabinet frame
- Integrated grounding tabs to electrically bond the side panel to cabinet frame
- Includes: Side panel (2 halves, with brushes), hardware, set of keys

| Frame Style | | Part Number | | | | | | | | | | | Cabinet Frame Depth in (mm) | Shipping Weight lb (kg) |
|-------------|---------|-------------|------|------|------|------|------|------|------|------|-------------|-----------|-----------------------------|-------------------------|
| | | Height (U) | | | | | | | | | | | | |
| 6-Slide | 4-Slide | 42 | 43 | 44 | 45 | 46 | 47 | 48 | 49 | 50 | 51 | 52 | | |
| 39047 | 39043 | -X00 | -X17 | -X34 | -X51 | -X68 | -X85 | -XAC | -XAY | -XBU | -XCP | -XDL | 31.5 (800) | 44 (20.0) |
| | | -X01 | -X18 | -X35 | -X52 | -X69 | -X86 | -XAD | -XBA | -XBV | -XCR | -XDM | 32.5 (825) | 46 (20.9) |
| | | -X02 | -X19 | -X36 | -X53 | -X70 | -X87 | -XAE | -XBB | -XBW | -XCT | -XDN | 33.5 (850) | 47 (21.3) |
| | | -X03 | -X20 | -X37 | -X54 | -X71 | -X88 | -XAF | -XBC | -XBY | -XCU | -XDP | 34.4 (875) | 49 (22.2) |
| | | -X04 | -X21 | -X38 | -X55 | -X72 | -X89 | -XAG | -XBD | -XCA | -XCV | -XDR | 35.4 (900) | 50 (22.7) |
| | | -X05 | -X22 | -X39 | -X56 | -X73 | -X90 | -XAH | -XBE | -XCB | -XCW | -XDT | 36.4 (925) | 52 (23.6) |
| | | -X06 | -X23 | -X40 | -X57 | -X74 | -X91 | -XAJ | -XBF | -XCC | -XCY | -XDU | 37.4 (950) | 53 (24.0) |
| | | -X07 | -X24 | -X41 | -X58 | -X75 | -X92 | -XAK | -XBG | -XCD | -XDA | -XDV | 38.4 (975) | 55 (24.9) |
| | | -X08 | -X25 | -X42 | -X59 | -X76 | -X93 | -XAL | -XBH | -XCE | -XDB | -XDW | 39.4 (1000) | 56 (25.4) |
| | | -X09 | -X26 | -X43 | -X60 | -X77 | -X94 | -XAM | -XBJ | -XCF | -XDC | -XDY | 40.4 (1025) | 58 (26.3) |
| | | -X10 | -X27 | -X44 | -X61 | -X78 | -X95 | -XAN | -XBK | -XCG | -XDD | -XEA | 41.3 (1050) | 59 (26.8) |
| | | -X11 | -X28 | -X45 | -X62 | -X79 | -X96 | -XAP | -XBL | -XCH | -XDE | -XEB | 42.3 (1075) | 61 (27.7) |
| | | -X12 | -X29 | -X46 | -X63 | -X80 | -X97 | -XAR | -XBM | -XCJ | -XDF | -XEC | 43.3 (1100) | 62 (28.1) |
| | | -X13 | -X30 | -X47 | -X64 | -X81 | -X98 | -XAT | -XBN | -XCK | -XDG | -XED | 44.3 (1125) | 64 (29.0) |
| | | -X14 | -X31 | -X48 | -X65 | -X82 | -X99 | -XAU | -XBP | -XCL | -XDH | -XEE | 45.3 (1150) | 65 (29.5) |
| | | -X15 | -X32 | -X49 | -X66 | -X83 | -XAA | -XAV | -XBR | -XCM | -XDJ | -XEF | 46.3 (1175) | 67 (30.4) |
| -X16 | -X33 | -X50 | -X67 | -X84 | -XAB | -XAW | -XBT | -XCN | -XDK | -XEG | 47.2 (1200) | 68 (30.8) | | |

X=color: C=Black, E=Glacier White. Shipping Weights are for 4-Slide, 52U panels. 6-Slide panels are approximately 8 lb (3.6 kg) lighter.



25190-001

Brush Port Kit is 2 halves that snap together around cables and forms a seal



39133-001

Cable Port Brush Kit

Cable Port Brush Kit covers over cable openings, protects cables as they pass through bottom panel, provides a 3.9"W x 8.8"D (99 mm x 223 mm) pass through area for cables

Equipment Rail Grommet Kit

Set of plastic grommets that cover cable openings in the equipment mounting rails in the wider cabinets to block airflow around equipment.

| Part Number | Description H x W (in) | Shipping Weight lb (kg) |
|-------------|--|-------------------------|
| 25190-001 | Cable Port Brush Kit, Pack of 2, Black | 2 (0.9) |
| 39133-001 | Equipment Rail Grommet Kit, Pack of 8, Black | 2 (0.9) |



Side Panel with Grommet Seal Openings

Side Panel with Grommet Seal Openings features multiple grommet-sealed cable openings that allow cables to enter the side of the cabinet, while containing exhaust air within each cabinet.

- 2-piece design with top and bottom halves for easier handling
- 8 cable openings per side, 4 per half-height panel, 1 per corner, are 4.5"W x 9"D (114 mm x 228 mm) without grommet, sized for large power plugs
- Grommets are plastic, snap-on, seal cable opening and can be cut to pass cables
- Tool-less removal, drop in design with integrated locking spring latch secures the side panel to the cabinet frame
- Integrated grounding tabs to electrically bond the side panel to cabinet frame
- Includes: Side panel (2 halves, with grommets), installation hardware, set of keys

| Part Number | | | | | Cabinet Frame Depth in (mm) | Shipping Weight lb (kg) | |
|-------------|---------|------------|------|------|-----------------------------|-------------------------|-----------|
| Frame Style | | Height (U) | | | | | |
| 6-Slide | 4-Slide | 42 | 45 | 48 | 52 | | |
| 39037 | 39033 | -X00 | -X51 | -XAC | -XDL | 31.5 (800) | 44 (20.0) |
| | | -X08 | -X59 | -XAL | -XDW | 39.4 (1000) | 56 (25.4) |
| | | -X10 | -X61 | -XAN | -XEA | 41.3 (1050) | 59 (26.8) |
| | | -X12 | -X63 | -XAR | -XEC | 43.3 (1100) | 62 (28.1) |
| | | -X16 | -X67 | -XAW | -XEG | 47.2 (1200) | 68 (30.8) |

X=color: C=Black, E=Glacier White. Shipping Weights are for 4-Slide, 52U panels. 6-Slide panels are approximately 8 lb (3.6 kg) lighter.



Air Director

Air Director is an angled panel used at the back of cabinets with Vertical Exhaust duct top panels to guide hot air toward the top of the cabinet.

- Universal, 3-piece design adjusts in width to fit all cabinets
- Attaches to the bottom slide on the cabinet, adjusts in depth
- Includes: director, installation hardware

| Part Number | Description H x W (in) | Shipping Weight lb (kg) |
|-------------|------------------------|-------------------------|
| 39107-X00 | Air Director | 10 (4.5) |

X=color: C=Black, E=Glacier White.



Front-to-Rear Cable Manager

Front-to-Rear Cable Manager attaches to the back of equipment mounting rails, creating a front-to-rear pathway between the front and rear mounting rails for cables.

- For use on 27.6"W (700 mm) and 31.5"W (800 mm) cabinets
- Mounting locations behind cable openings on each rail
- Attaches to mounting rails and extends to match depth
- Creates a 2.5"W (64 mm) x 3"D (78 mm) front-to-rear pathway for cables

| Part Number – Cabinet Width | | | Rail Depth Range in (mm) | Shipping Weight lb (kg) |
|-----------------------------|-----------------|-----------------|--------------------------|-------------------------|
| 23.6"W (600 mm) | 27.6"W (700 mm) | 31.5"W (800 mm) | | |
| N/A | 39077-X00 | 39077-X00 | 22-34 (558-863) | 5 (2.3) |

X=color: C=Black, E=Glacier White.

Cabinet Accessories

Bay Seal Kit

Bay Seal Kit is only used with 23.6" W (600 mm) cabinets when the cabinets are bayed to align with 24" W (610 mm) floor tiles. The bay seal kit fills the small gaps left between cabinets.

- Flexible plastic insert that blocks airflow between cabinets
- Includes: side baffles, cut to length
- Material: Plastic; Finish: Black only



Seal Kit

Cover unused holes in the frame to prevent bypass airflow.

- Pre-cut, plastic, color-matched, adhesive backed labels for easy attachment
- Tough, heat resistant material and adhesive for long life
- Each kit includes 12 sheets; 21 round labels and six rectangular labels
- Round labels are .75" (19 mm) diameter. Rectangular labels are 1.3" x 2.2" (34 mm x 55 mm).
- Material: Thermoplastic polycarbonate film
- Select to match the color of the cabinet

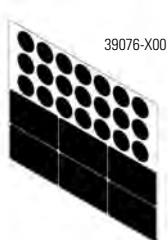

Ramp Kit for Shock Pallet Cabinets

Ramp Kit includes a pair of steel ramps used to roll a loaded cabinet off of a shock pallet.

- Durable, welded steel construction for repeated use
- 0.7" H (17.4 mm) sides control casters to prevent the cabinet from rolling off ramp
- Gradual, 4.5° L (1.4 m) incline for controlled exit
- Includes: one pair of steel, black finish ramps
- Order one Ramp Kit per site for Shock Pallet Cabinets

Leveling Feet Height Adjustment Tool

- Used in drill/driver to adjust the height of leveling feet.
- 5 mm Hex Ball Driver Tool; 12" L (300 mm)

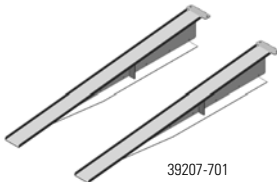

| Part Number | Description | Shipping Weight lb (kg) |
|-------------|---|-------------------------|
| 39137-700 | Bay Seal Kit, For 42U | 5 (2.3) |
| 39137-703 | Bay Seal Kit, For 45U | 5 (2.3) |
| 39137-706 | Bay Seal Kit, For 48U | 5 (2.3) |
| 39137-710 | Bay Seal Kit, For 52U | 5 (2.3) |
| 39076-X00* | Seal Kit, Pack of 12 | 1 (0.5) |
| 39207-701 | Ramp Kit for Shock Pallet Cabinets, Black | 26 (11.8) |
| 39150-001 | Adjustment Tool, Hex Ball Driver | 1 (0.5) |

*X=Color: C=Black, E=Glacier White.

The N-Series TeraFrame Gen 3 Network Cabinet System

Includes large cable entry ports on the top panel, T-shaped cable guides on the front mounting rails and a front-to-rear cable manager to organize cables; vertical cable managers are available as accessories.

Dual slides provide maximum flexibility for mounting and positioning vertical cable management accessories and attaching overhead cable pathway and containment structures.

Frame design provides maximum flexibility for mounting equipment, thermal, cable and power management accessories.

Highly flexible side intake duct that can be adjusted on-site to accommodate a range of switch sizes and manufacturers.

Allows for different size switches to be deployed simultaneously in the same cabinet without additional accessory kits.



PATENTED
Vertical Exhaust Duct

Supports CPI Aisle Containment Solution and has a Vertical Exhaust Duct option available to maintain your data center Aisle Containment strategy.

Frames support up to 2500 lb (1134 kg), static load on leveling feet per UL 2416.

Air Dams - Order the cabinet configured with Air Dams to create front-to-rear or front-to-top airflow.

Side Intake Duct - Order the cabinet configured with Side Intake Duct to create side-to-rear or side-to-top airflow.

Bottom panel - Included with cabinets that have an Air Manager or Vertical Exhaust Duct top panel.

Engineered solution designed for high-density network and storage switches and cabling. Provides complete separation of hot and cold air within the cabinet to expand your data center aisle containment strategy to your network infrastructure.

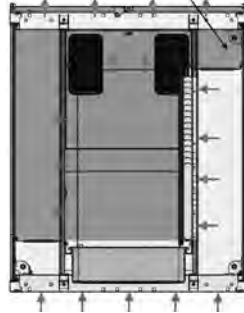

Order the cabinet with a Side Intake Duct when deploying network switches that require side airflow. Use with Snap-In Filler Panels to provide complete front/rear cold/hot air separation within the cabinet.

N-Series TeraFrame Gen 3 Network Cabinet

The N-Series TeraFrame Gen 3 Cabinet System is a network cabinet engineered for high-density cable and thermal management. Network cabinets are unique from server cabinets because they must manage large quantities of cables at both the front and rear of the cabinet, as well as control a mix of front-to-rear and side-to-side airflow through equipment.

To manage network cables, the cabinet includes plastic T-shaped cable management guides (fingers) attached to the front pair of equipment mounting rails with openings that align with each rack mount space (U) for patch cords, and a front-to-back cable manager along the side. Additionally, there is a large, full-depth cable opening above both sides of the cabinet covered by a brush-sealed or plastic grommet to block bypass airflow.

To control airflow for switches, the cabinet offers a Vertical Exhaust Duct or perforated rear doors, as well as integrated internal air dams in four standard preconfigured solutions: front-to-rear, front-to-top, side-to-rear or side-to-top airflow. Front-to-rear airflow includes air dams that block airflow around equipment and perforated rear doors, so hot air exits the rear of the cabinet. Front-to-top airflow includes a bottom panel, solid rear door and Vertical Exhaust Duct, so hot air exits the top of the cabinet. Side airflow combines a front air dam and a side intake duct. The side intake duct is a full-height plastic panel that is trimmed to match the intake on the switch, a universal solution that does not require you to know which switch will be used. Side-to-top airflow combines the Vertical Exhaust Duct kit, air dam and side intake duct with a partially perforated rear door. Cold air enters the front or rear of the cabinet to provide additional cold air for high-density switches, and hot air exits the top of the cabinet.

Cabinet Specifications:

- Available in multiple heights, widths and depths
- Available with integrated cable and thermal management accessories to meet front-to-rear and side airflow requirements
- Includes 2 pairs of mounting rails in the cabinet; Adjustable depth, rails slide front-to-back, marks on the frame for easy vertical alignment
- Static load rating: 2500 (1134 kg) on leveling feet

Cabinet Includes:

- (1) Welded steel and bolted aluminum four-post Frame
- (2) Equipment Mounting Rails, Pairs
- (1) Perforated Front Door with Swing Handle
- (1) Solid, Perforated or partially Perforated Rear Door options
- (1) Top Panel, 2 full-depth brush sealed or grommeted cable openings
- (4) Leveler Feet, Transport Casters and Floor attachment brackets
- (1) Ground System and Ground Lug
- (1) Baying Kit
- (1) PDU brackets, (1) pair, for (2) 2.2"W (56 mm) vertical CPI PDUs
- (1) Bag of 50 M6 Klik-Nut cage nuts and screws (square-punched rails)
- (1) Bag of 50 Each #12-24 Rack Channel Mounting Screws (tapped rails)

Certifications:

- EIA-310-E compliant
- UL Listed 2416, NWIN, File #E227626

N-SERIES TERAFRAME® GEN 3 NETWORK CABINET SYSTEM

Use the part number matrix below to configure a N-Series TeraFrame Gen 3 Cabinet. Choose the **Height**, **With** or **Without Duct**, **Depth**, **Rail Style**, **Front Door**, **Rear Door**, **Latch**, **Color**, **Top Panel Style**, **Side Panel Style** and **Cable Entry Style**. **Example Cabinet Part Number: NF5U-114C-E52-1**.

| | | | | | | | | | | | | | | |
|----------|----------|----------|----------|----------|----------|----------|----------|----------|----------|----------|----------|----------|----------|----------|
| N | H | W | D | - | R | F | R | L | - | C | T | S | - | E |
|----------|----------|----------|----------|----------|----------|----------|----------|----------|----------|----------|----------|----------|----------|----------|

| 1. Height | | | C |
|-----------|------|----|----------|
| in | mm | U | |
| 78.1 | 1984 | 42 | C |
| 79.9 | 2029 | 43 | D |
| 81.6 | 2073 | 44 | E |
| 83.4 | 2117 | 45 | F |
| 85.1 | 2162 | 46 | G |
| 86.9 | 2206 | 47 | H |
| 88.6 | 2251 | 48 | J |
| 90.4 | 2295 | 49 | K |
| 92.1 | 2340 | 50 | L |
| 93.9 | 2384 | 51 | M |
| 95.6 | 2429 | 52 | N |

Height includes transport casters.

| 2. Width | | Included Air Manager | | 0 |
|----------|------|----------------------|--|----------|
| in | mm | | | |
| 31.5 | 800 | No Air Manager | | 0 |
| 31.5 | 800 | Front Air Dams | | 7 |
| 31.5 | 800 | Side Intake Duct | | 1 |
| 40.0 | 1016 | No Air Manager | | 6 |
| 40.0 | 1016 | Front Air Dams | | 8 |
| 40.0 | 1016 | Side Intake Duct | | 5 |

40.0"W (1016 mm) cabinets are only available 43.3"D (1100 mm) or deeper.

| 3. Depth | | With Doors | | J |
|----------|------|------------|------|----------|
| in | mm | in | mm | |
| 39.4 | 1000 | 43.3 | 1100 | J |
| 40.4 | 1025 | 44.3 | 1125 | K |
| 41.3 | 1050 | 45.3 | 1150 | L |
| 42.3 | 1075 | 46.3 | 1175 | M |
| 43.3 | 1100 | 47.3 | 1200 | N |
| 44.3 | 1125 | 48.2 | 1225 | P |
| 45.3 | 1150 | 49.2 | 1250 | R |
| 46.3 | 1175 | 50.2 | 1275 | T |
| 47.2 | 1200 | 51.2 | 1300 | U |

Frame Depth does not include doors. Front door adds 2.4" (61 mm). Rear door adds 1.5" (38 mm).

| 4. Equipment Mounting Rail Style | | 1 |
|----------------------------------|--|----------|
| Square Punch, 2 Pair | | |
| Tapped, #12-24, Pair | | 2 |

| 11. Cable Entry Cover | |
|-----------------------|-----------------|
| 0 | Plastic Grommet |
| 1 | Brush Sealed |

| 10. Side Panel Style | |
|----------------------|---------------|
| 0 | None |
| 1 | Solid, 1 each |
| 2 | Solid, 2 each |

Include side panels on all cabinets with Front Air Dams or Side Intake Duct Air Managers.

| 9. Top Panel | |
|--------------|---|
| 4 | Standard Top |
| 5 | Vertical Exhaust Duct, 20"-34"H (508-863 mm) |
| 6 | Vertical Exhaust Duct, 34"-60"H (863-1523 mm) |
| 7 | Vertical Exhaust Duct, 14"-20"H (356-508 mm) |

Options 5, 6, & 7 are for cabinets that are 41.3"D (1050 mm) or deeper. Use Solid Metal Rear Door or Solid Metal with Perforated Insert Rear Door with Vertical Exhaust Duct. Vertical Exhaust Duct includes a Bottom Panel.

| 8. Color | |
|----------|---------------|
| C | Black |
| E | Glacier White |

| 7. Latch/Lock Kits | |
|--------------------|--|
| C | Two-Point, Keyed Lock |
| E | Two-Point, Cam Latch, Combination Lock |
| N | None |

There is a single-point latch on front door that matches GF-Series GlobalFrame Gen 2 Cabinet.

| 6. Rear Door Style | |
|--------------------|------------------------------------|
| 0 | None |
| 3 | Double, Perforated Metal |
| 4 | Solid Metal with Perforated Insert |
| 5 | Solid Metal |

Use Double Perforated Metal door with Standard Top Panel. Use Solid Metal with Perforated Insert with Vertical Exhaust Duct and Side Intake Duct. Use Solid Metal door with Vertical Exhaust Duct and Air Dams. Solid Metal with Perforated Insert and Solid Metal doors are single doors on the 31.5"W (800 mm) cabinet and double doors on the 40.0"W (1016 mm) cabinet.

| 5. Front Door Style | |
|---------------------|---|
| 0 | None |
| 1 | Perforated Metal, matches F-Series TeraFrame Gen 3 Cabinet |
| 2 | Perforated Metal, matches GF-Series GlobalFrame Gen 2 Cabinet |

Single door on the 31.5"W (800 mm). Double door on the 40.0"W (1016 mm).

Specifications/Ordering Notes:

1. Height, Widths, Depths: See tables below for detailed dimensions.
2. Width/Included Air Manager: Order your cabinet configured with internal air managers to support front-to-rear airflow or side airflow. See the next page for standard air manager, rear door and top panel configurations.
7. Latch/Lock Kits: There is a single-point latch on the front door that matches GF-Series GlobalFrame Gen 2 Cabinet.
10. Side Panel Style: Include side panels on all cabinets with Front Air Dams and Side Intake Duct Air Managers.
11. Cable Entry Cover: N-Series Cabinet has front-to-rear cable openings along both sides of the cabinet. Cable Entry Cover identifies the type of cover included with the cabinet to seal the openings. The Plastic Grommet is a solid plastic grommet that can be cut to pass cables. The Brush Sealed cover forms around cables. All cabinets include covers at the top of the cabinet. Cabinets that include Front Air Dams or Side Intake Duct Air Managers have covers at the bottom of the cabinet also.

Top View

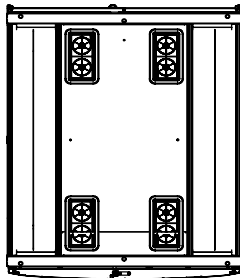

Front View

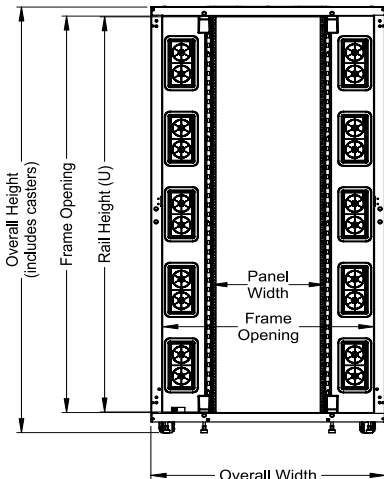

Side View

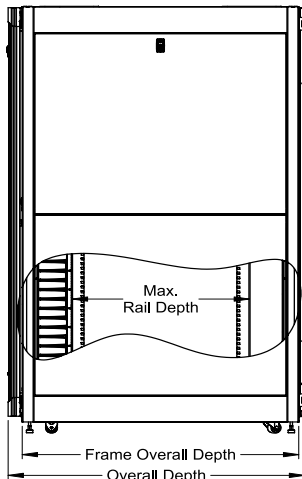

Simplify ordering, shipping and installation by requesting eConnect PDUs and eConnect RFID Electronic Lock Kit to be installed in CPI's GF-Series GlobalFrame or F-Series TeraFrame cabinets before they leave the factory. Request Redundancy Pack for easy identification of primary and secondary units.

Add power. Make it easy.

Cabinet Example Configurations:



Front-To-Rear Airflow - Example P/N: NX7X-XX3X-X4X-X
Combine Front Air Dams with Perforated Rear Door and Standard Top Panel. Front Air Dams block airflow around the sides of equipment.

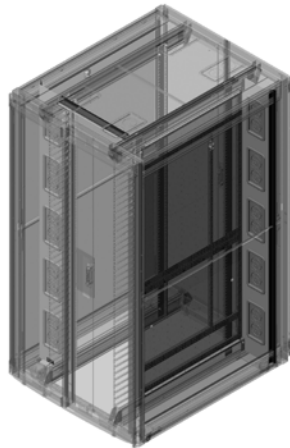

Side-To-Rear Airflow - Example P/N: NX5X-XX3X-X4X-X
Combine Side Intake Duct with Perforated Rear Door and Standard Top Panel. Side Intake Duct allows cold air to enter either side of a switch.



Front-To-Top Airflow - Example P/N: NX7X-XX5X-X5X-X
Combine Front Air Dams with Solid Metal Rear Door and Vertical Exhaust Duct Top Panel to remove hot air through the top of the cabinet.

PATENTED
Vertical
Exhaust Duct

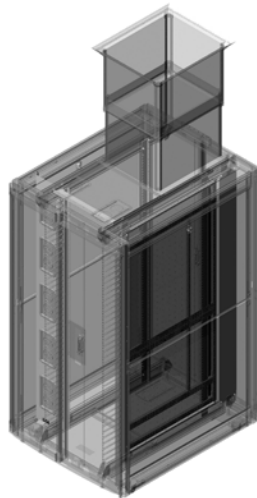

Side-To-Top Airflow - Example P/N: NX5X-XX4X-X5X-X
Combine Side Intake Duct with Solid Metal Rear Door with Perforated Insert and Vertical Exhaust Duct Top Panel. Side airflow; top exhaust.



Ring Cable Manager

Ring Cable Manager creates a simple vertical pathway for patch and jumper cords. Use to support cords near the front of the cabinet.

- Attaches to the frame, adjusts in depth independent of the equipment mounting rails
- Rings have an opening on the front for easy addition and removal of cables
- Includes: bracket, rings and installation hardware
- Material: Steel bracket, plastic rings
- Select part number to match the width, usable height and color of the cabinet

| Cabinet Width 31.5" W (800 mm) | Cabinet Width 40.0" W (1016 mm) | Height (U) | Shipping Weight lb (kg) |
|--------------------------------------|---------------------------------------|---------------|-------------------------------|
| 39128-X00 | 39129-X00 | 42 | 14 (6.4) |
| 39128-X01 | 39129-X01 | 43 | 14 (6.4) |
| 39128-X02 | 39129-X02 | 44 | 14 (6.4) |
| 39128-X03 | 39129-X03 | 45 | 14 (6.4) |
| 39128-X04 | 39129-X03 | 46 | 14 (6.4) |
| 39128-X05 | 39129-X05 | 47 | 15 (6.8) |
| 39128-X06 | 39129-X06 | 48 | 15 (6.8) |
| 39128-X07 | 39129-X07 | 49 | 15 (6.8) |
| 39128-X08 | 39129-X08 | 50 | 15 (6.8) |
| 39128-X09 | 39129-X09 | 51 | 15 (6.8) |
| 39128-X10 | 39129-X10 | 52 | 15 (6.8) |

X=color; C=Black, E=Glacier White. Shipping Weights are for 40.0" W (1016 mm) managers.

Cabinet Notes: Use Snap-In Filler Panels, page 1-9, in cabinets with square-punched mounting rails to seal any open rack-mount space (U) once all equipment is installed.

Use Full Height PDU Bracket, page 1-12, to support PDUs in the cabinet.

| Inside Dimensions, Usable Internal Cable Area | | | |
|---|---------------|---------------|--|
| Cabinet Width | Width in (mm) | Depth in (mm) | Cable in ² (mm ²) |
| 31.5 (800) | 2.3 (58) | 5.5 (140) | 12.6 (8130) |
| 40.0 (1016) | 4.2 (107) | 3.5 (89) | 14.7 (9480) |

Telescoping Cable Manager

Telescoping Cable Manager attaches to the sides of the front and rear equipment mounting rail providing a front-to-rear or vertical pathway for cables.

- Attaches to and adjusts in depth with mounting rails, fully compatible with Front Air Dams and Side Intake Duct
- (5) smooth, plastic L-shaped spools support cables
- Spools on 31.5" W (800 mm) model are 2.5" H x 2.6" D (64 mm x 66 mm)
- Spools on 40.0" W (1016 mm) model are 3.3" H x 6.8" D (84 mm x 173 mm)
- Spools rotate and lock in 90-degree increments and can be adjusted to manage horizontal or vertical cable runs
- Includes: cable manager, (5) cable spools, installation hardware
- Material: Steel manager, plastic spools. Finish: Black or Glacier White
- Select part number to match the color of the cabinet

| Cabinet Width 31.5" W (800 mm) | Cabinet Width 40.0" W (1016 mm) | Height (U) | Shipping Weight lb (kg) |
|--------------------------------------|---------------------------------------|---------------|-------------------------------|
| 39377-X01 | 39377-X02 | Any | 5 (2.3) |

X=color; C=Black, E=Glacier White. Shipping Weights are for 1016 mm kits.





Cable Lashing Manager

Use to support network cables along the sides of the cabinet.

- Attaches to the frame, adjusts in depth independent of the mounting rails.
- Slim manager is 5"W (130 mm) and has 3 vertical columns of attachment points for 1.5" (38 mm) diameter cable bundles, 5 in² (3200 mm²) cable fill area
- Wide manager is 9.8"W (250 mm) and has 5 vertical columns of attachment points for 1.5" (38 mm) diameter cable bundles, 9.8 in² (6320 mm²) cable fill
- Includes: Bracket and installation hardware, order Saf-T-Grips or cable ties separately; Material: Steel

| Slim 5.1"W (130 mm) | Slim 9.8"W (250 mm) | Height (U) | Shipping Weight lb (kg) |
|---------------------------|---------------------------|---------------|-------------------------------|
| 39380-X00 | 39381-X00 | 42 | 19 (8.9) |
| 39380-X01 | 39381-X01 | 43 | 20 (9.1) |
| 39380-X02 | 39381-X02 | 44 | 20 (9.1) |
| 39380-X03 | 39381-X03 | 45 | 21 (9.5) |
| 39380-X04 | 39381-X04 | 46 | 21 (9.5) |
| 39380-X05 | 39381-X05 | 47 | 21 (9.5) |
| 39380-X06 | 39381-X06 | 48 | 22 (10.0) |
| 39380-X07 | 39381-X07 | 49 | 22 (10.0) |
| 39380-X08 | 39381-X08 | 50 | 23 (10.4) |
| 39380-X09 | 39381-X09 | 51 | 23 (10.4) |
| 39380-X10 | 39381-X10 | 52 | 24 (10.9) |

X=Color; C=Black, E=Glacier White. Shipping Weights for wide managers.

Radius Drop

- Attaches to the top of the cabinet to support cables
- Radius drop is 11"L (279 mm) with a 1.3" (33 mm) diameter radius
- Includes: radius drop, installation hardware. Material: Aluminum

| Cabinet Width 31.5"W (800 mm) | Cabinet Width 40.0"W (1016 mm) | Height (U) | Shipping Weight lb (kg) |
|-------------------------------------|--------------------------------------|---------------|-------------------------------|
| 39327-X01 | 39327-X01 | Any | 1 (0.5) |

X=Color; C=Black, E=Glacier White.

Tool-less Bend Radius Kit; Fiber Patch Cords

Tool-less Bend Radius Kit for Fiber Patch Cords ensures proper bend radius support for fiber optic patch cords. Color is Black.

- Compatible with N-Series TeraFrame® Gen 3 Network Cabinet System, Evolution and Motive Cable Management

| Part Number | Description | Shipping Weight lb (kg) |
|-------------|---------------------------------------|-------------------------------|
| 32697-001 | Tool-less Bend Radius Kit, Pack of 10 | 1 (0.5) |
| 32697-002 | Tool-less Bend Radius Kit, Pack of 50 | 3 (1.4) |

Notes: Also compatible with accessory cable management finger kits for SeismicFrame Two-Post Rack, Adjustable Rail QuadraRack and Adjustable Rail ServerRack (see P/N 13696-00X and 15286-00X, respectively)



Load-Tested
GR-63
Zone 4

California
OSHPD
OPM-0112-13

OSHPD OPM-0112-13 provides pre-approved, code-compliant seismic designs of supports and attachments for the cabinet when used in health facilities in California.

Z4-Series SeismicFrame Cabinet System

The Z4-Series SeismicFrame Cabinet System is an engineered solution specifically designed to store critical rack-mount server, data storage and network equipment in computer rooms, equipment rooms and other communications facilities that are located in active seismic areas.

Featuring an industry-leading 1500 lb (680 kg) equipment load, the Z4-Series SeismicFrame can also support an additional 100 lb (45 kg) top load for cabling. This cabinet was tested by a Telecommunications Carrier Group and ISO 17025 certified Independent Testing Laboratory (ITL) to meet the Telcordia Technologies GR-63-CORE, Issue 4, April 2012, Sections 4.4 per Zone 4 requirements. GR-63-CORE seismic testing includes a series of physical shaker table tests, during which a loaded cabinet is placed through simulated earthquake conditions. Zone 4 testing includes the most severe test conditions, in which the cabinet must perform with limited movement and survive the test without permanent structural or mechanical damage, ensuring the internal equipment is not damaged.

The cabinet is available with optional solid top panel, solid side panels and perforated doors. Top panel has four cable ports (one per corner). The side panels bolt on, and include locks. The front door is a single door with single point latch. The rear door is double (vertically split) with a three-point latch. Combine the Z4-Series SeismicFrame Cabinet with thermal and cable management accessories to create a solution that fits your exact needs.

Cabinet Specifications:

- Available in 2 heights, 2 widths, 2 depths
- Provides front and rear support for 19"W (482.6 mm) EIA rack-mount equipment and shelves
- Adjustable depth, rails slide front-to-back
- Marks on frame for easy vertical alignment
- 1-3/4"H (44.45 mm) U spacing, marked and numbered
- 19"W, EIA-310-E Universal vertical hole spacing
- Seismic Load: 1500 lb (680 kg) internal seismic equipment load
100 lb (45 kg) additional cabinet roof load
- Static Load: 3000 lb (1360 kg) per UL2416

Cabinet Includes:

- Welded and bolted steel four-post frame
- Equipment mounting rails, two pairs
- Grounding/bonding system and ground lug
- Recessed leveling feet
- Removable transport casters
- Baying kit
- Equipment mounting hardware, (50) M6 cage nuts and screws

Certifications:

- EIA-310-E compliant
- UL Listed 2416, NWIN, File #E227626
- TCG NEBS Compliant, Telcordia Technologies, GR-63-CORE, Issue 4, April 2012, Sections 4.4, per Zone 4 requirements
- OSHPD OPM-0112-13 California, Office of Statewide Health Planning and Development (OSHPD), Preapproval of Manufacturer's Certification (OPM)

Z4-Series SeismicFrame Cabinets – Frame Only, No Top Panel, No Doors, or Side Panels.

| | | | | | | | | | | | | | |
|----|---|---|---|---|---|---|----|----|---|---|---|----|----|
| Z4 | - | H | W | D | - | R | FD | RD | L | - | C | TP | SP |
|----|---|---|---|---|---|---|----|----|---|---|---|----|----|

| Height | | |
|--------|------|------|
| U | in | mm |
| 40 | 78.7 | 1999 |
| 43 | 83.9 | 2132 |

| Width | | |
|-------|-----|---|
| in | mm | |
| 23.6 | 600 | 1 |
| 31.5 | 800 | 2 |

| Depth | | |
|-------|------|---|
| in | mm | |
| 41.3 | 1050 | N |
| 47.3 | 1200 | U |

| Rails | |
|----------------|---|
| Square-Punched | 1 |

| Front Doors | |
|-------------|---|
| None | 0 |

| Rear Door | |
|-----------|---|
| None | 0 |

| Latches | |
|---------|---|
| None | 0 |

| Side Panels | |
|-------------|------|
| 0 | None |

| Top Panel | |
|-----------|------|
| 0 | None |

| Color | |
|-------|---------------|
| C | Black |
| E | Glacier White |



Z4-12U-1000-C00 shown

Specifications/Ordering Notes:

- There are eight possible frame sizes.
- Use the first matrix to order a complete cabinet with top, doors and sides; use the second matrix to order a cabinet with no doors; use the last matrix to order a Frame Only with no top, doors or sides.
- You must include a top panel when ordering a cabinet with doors.
- You can order a cabinet with or without side panels.
- You can order a cabinet with or without a front door.
- Choose latch/lock style: keyed or combination/keyed. Every door must have a latch. The (0) option should only be selected if there are no doors. Doors have a swing handle on the exterior. The combination lock uses a 3-digit combination entered on three-dials that are integrated into the swing handle or a key. The combination lock can be reprogrammed in the field.
- The front door has a single-point latch; the rear door has a two-point latch.
- Heights, Widths, Depths: see tables below for detailed dimensions.

| Height Dimensions - in (mm) | | | |
|-----------------------------|----------------------|-----------------------|---------------|
| Rack Mount Spaces (U) | Overall with Casters | Frame Only No Casters | Front Opening |
| 40 | 78.7 (1999) | 77.4 (1965) | 70.4 (1789) |
| 43 | 83.9 (2132) | 82.6 (2099) | 75.7 (1922) |

Casters are factory-installed on the cabinet, used to move the cabinet into position and then removed before installation. The cabinet frame attaches directly to the floor.

| Depth Dimensions - in (mm) | | | |
|----------------------------|--------------------|---------------------|--------------------|
| Nominal Depth | Overall with Doors | Frame Only No Doors | Maximum Rail Depth |
| 1050 | 45.1 (1146) | 41.3 (1050) | 35.8 (911) |
| 1200 | 51.1 (1296) | 47.2 (1200) | 41.7 (1061) |

Front Door is approximately 2.2"D (56 mm), and Rear Door is approximately 1.7"D (43 mm) with hinges/latches. Minimum rail depth is 10.2" (258 mm). The front rail is 6.7" (170 mm) deep; the rear rail is 3.5" (89 mm) deep. Rail Depth is reduced when vertical accessories are placed in corners.

| Width Dimensions - in (mm) | | | |
|----------------------------|--------------------------|---------------|------------------------|
| Nominal Depth | Overall with Side Panels | Front Opening | Rack-Mount Panel Width |
| 600 | 23.6 (600) | 19.6 (498) | 19 (482.6) |
| 800 | 31.5 (800) | 27.5 (698) | 19 (482.6) |

Mounting Rail clearance is 17.8" (452 mm), mounting hole spacing is 18.3" (465 mm).



Air Dam Kit

Air Dam blocks airflow around the sides and top of the equipment mounting space, so cold air passes through equipment, and hot air does not recirculate around equipment.

- Use with Snap-In Filler Panels and Equipment Rail Grommet Kit
- Attaches to and adjusts with mounting rails
- Requires a minimum rail setback of 2.3" (58 mm) from the front of the frame
- Flexible seal against top and side panels
- Includes: top, bottom and side baffles; installation hardware
- Material: Steel baffles, plastic seals
- Select part number to match the width, usable height and color of the cabinet

| Part Number 23.6"W (600 mm) | Part Number 31.5"W (800 mm) | Height (U) | Shipping Weight lb (kg) |
|-----------------------------------|-----------------------------------|---------------|-------------------------------|
| 14435-X00 | 14435-X02 | 40 | 14 (6.4) |
| 14435-X01 | 14435-X03 | 43 | 15 (6.8) |

X=Color, C=Black, E=Glacier White. Shipping Weights are for 800 mm kits.

Cable Lashing Bracket

Cable Lashing Bracket creates a simple, separate vertical pathway for a small bundle of cables and has multiple slots for CPI Saf-T-Grip® Straps or tie wraps to secure cables to the bracket.

- Attaches to the frame in a fixed location, independent of the equipment rails
- Use multiple to increase capacity
- Bracket is 1.6"W (41 mm)
- Includes: brackets, installation hardware; order Saf-T-Grips or cable ties separately
- Material: Steel

| Part Number | Height (U) | Shipping Weight lb (kg) |
|----------------|---------------|-------------------------------|
| 14465-X00 | 40 | 3 (1.4) |
| 14465-X01 | 43 | 3 (1.4) |

X=Color, C=Black, E=Glacier White.

Front-To-Rear Cable Manager

Front-to-Rear Cable Manager attaches to the back of equipment mounting rails, creating a front-to-rear pathway between the front and rear mounting rails for cables.

- For use on 31.5"W (800 mm) cabinets
- Mounting locations behind cable openings on each rail
- Attaches to mounting rails and extends from 17.5" (445 mm) to 30.5" (775 mm) to match rail depth
- Creates a 3.0"H (76 mm) by 2.5"W (64 mm) front-to-rear pathway for cables
- Includes: cable manager, installation hardware
- Material: Steel panels

| Part Number 23.6"W (600 mm) | Part Number 31.5"W (800 mm) | Height (U) | Shipping Weight lb (kg) |
|-----------------------------------|-----------------------------------|-------------------------|-------------------------------|
| N/A | 14485-X00 | 17.5 - 30.5 (445 - 775) | 6 (2.7) |

X=Color, C=Black, E=Glacier White.

Note: Color is black. Use with 31.5"W (800 mm) rails.



Ring Cable Manager

Ring Cable Manager is independent of the equipment mounting rails, creating a separate vertical pathway for cables and includes plastic cable rings to organize cables.

- Attaches to the frame in a fixed location, independent of the equipment mounting rails
- Rings have an opening on the front for easy addition or removal of cables
- Includes: brackets, rings, installation hardware
- Material: Steel brackets, plastic rings
- Select part number to match the width, usable height and color of the cabinet

| Part Number 23.6"W (600 mm) | Part Number 31.5"W (800 mm) | Height (U) | Shipping Weight lb (kg) |
|-----------------------------------|-----------------------------------|---------------|-------------------------------|
| 14440-X00 | 14445-X00 | 40 | 13 (5.9) |
| 14440-X01 | 14445-X01 | 43 | 13 (5.9) |

X=Color, C=Black, E=Glacier White. Shipping Weights are for 800 mm managers.

| Inside Dimensions, Usable Internal Cable Area, Rails Setback | | | | |
|--|------------------|------------------|--|-------------------------|
| Cabinet Width | Width in (mm) | Depth in (mm) | Cable Area in ² (mm ²) | Rail Setback in (mm) |
| 23.6 (600) | .9 (29) | 3.3 (84) | 2.9 (1870) | 9.5 (240) |
| 31.5 (800) | 4.2 (107) | 3.5 (89) | 14.7 (9480) | 9.7 (246) |



Full Height PDU Bracket, Dual and Wide

Full Height PDU Bracket supports two vertical PDUs side-by-side and has multiple slots for CPI Saf-T-Grip Straps or tie wraps to secure cords to the bracket. Available in two widths: Dual and Wide

- Attaches to the frame in a fixed location, independent of the equipment mounting rails
- Dual bracket is 4.8"W (121 mm) and supports (2) PDUs up to 2.2"W (56 mm) side-by-side
- Wide bracket is 5.8"W (147 mm) and supports (2) PDUs up to 2.7"W (69 mm) side-by-side
- Wide bracket is required to mount (2) 6-breaker eConnect PDUs (series P/Ns PX-3XXXX) side-by-side; eConnect PDUs (series P/Ns PX-3XXXX) will only fit in the 43U cabinet.
- Tool-less mounting on 28" (711 mm), 61.25" (1556 mm) or 64.75" (1645 mm) centers
- Includes: brackets, installation hardware; order Saf-T-Grips or cable ties separately
- Material: Steel
- Select part number to match PDU size, usable height and color of the cabinet

| Part Number Dual | Part Number Wide | Height (U) | Shipping Weight lb (kg) |
|---------------------|---------------------|---------------|-------------------------------|
| 14480-X00 | 14481-X00 | 40 | 12 (5.4) |
| 14480-X01 | 14481-X01 | 43 | 11 (5.0) |

X=Color, C=Black, E=Glacier White. Shipping weights are for Wide managers. eConnect PDUs (P/Ns PX-3XXXX) will not fit inside a 40U cabinet.

Raised Floor Grommet

Reduce bypass airflow and improve data center cooling efficiency with CPI's Raised Floor Grommets. Achieve an effective seal around cables with the dual-layer brush design with integrated membrane layer.

- Split design allows easy addition around existing cables. Add cable openings to the edge of floor tiles for easy addition or removal of cables
- Rectangular Raised Floor Grommet features EPDM membrane between two layers of nylon brushes that forms a superior seal around cable bundles
- 4" Round Raised Floor Grommet offers smaller form-factor where space is limited
- Durable sealing materials will not break, tear or deform from repeated use
- Available as singles or in carton of 10
- Black Finish



| Part Number | | Description | Shipping Weight lb (kg) |
|---|-----------|--|-------------------------|
| Each (1) | Pack (10) | | |
| Deluxe Filter Cabinet Ventilation System | | | |
| 13671-001 | 13671-002 | Raised Floor Grommet, 1-5/8" (41 mm) x 11" (279 mm) x 8-1/4" (210 mm) Overall Size; 9-1/4"W (235 mm) x 6-3/4"D (172 mm) required hole in floor | 18 (8.2) |
| 13874-001 | 13874-002 | 4" (102 mm) Round Raised Floor Grommet | 6 (2.7) |

Shipping Weights are for 10 pack.

Snap-In Filler Panel

Snap-In Filler Panel blocks airflow in between equipment by sealing unused rack-mount spaces (U) in the cabinet. Use with Air Dam Kit and Bottom Panel to separate cold and hot air within the cabinet.



| Part Number | | | Height (U) | Shipping Weight lb (kg) |
|-------------|-----------|-----------|------------|-------------------------|
| Each (1) | Each (6) | Each (50) | | |
| 34537-X00 | 34537-X01 | 34537-X02 | 1U | 14 (6.4) |
| 34538-X00 | 34538-X01 | 34538-X02 | 2U | 21 (9.5) |

X=Color; 0=Black, E=Glacier White. Shipping Weights are for 50 pack.

Hardware Kits



| Part Number | Nominal Size | Package Of | Finish | Shipping Weight lb (kg) |
|---|--------------|------------|----------------|-------------------------|
| Tapped Rail Hardware Kits (sold separately) | | | | |
| 40605-001 | 12-24 | 50 | Zinc | 1 (0.5) |
| 40605-004 | 12-24 | 1,000 | Zinc | 9 (4.1) |
| 40605-005 | 12-24 | 50 | Black | 1 (0.5) |
| 40605-006 | 12-24 | 1,000 | Black | 9 (4.1) |
| Square-Punched Hardware Kits (sold separately) | | | | |
| 12637-001 | M-6 | 25 | Gold over Zinc | 1 (0.5) |
| 12638-001 | 10-32 | 25 | Zinc | 1 (0.5) |
| 12639-001 | 12-24 | 25 | Black | 1 (0.5) |



Clik-Nut® Hardware Kit

Clik-Nut® Hardware Kit solves the fundamental issues with standard cage nuts. The design eliminates the need for tools, resulting in easier and faster installation, while maintaining load-bearing strength. Clik-Nut reduces labor and installation time by at least 70 percent.

Clik-Nut can be used wherever standard cage nuts are used and works anywhere along the rack panel surface when mounting, removing or repositioning IT equipment. Steel construction ensures the same load rating as standard cage nuts.

The squeeze-and-release design allows users to safely insert the Clik-Nut into mounting holes repeatedly, without the need for tools, reducing the risk of finger injuries or nuisances common during installation of traditional cage nuts.

- Multiple thread sets available: M6, 12-24, 10-32
- Engraved thread size provides easy identification
- Compatible with .375" (9.5 mm) square-punched holes in rails with thickness of 16 ga to 12 ga, .060" to .105" (1.52 mm to 2.67 mm)

| Part Number | Thread Size | Package Of | Shipping Weight lb (kg) |
|-------------|-------------|------------|-------------------------|
| 76543-X01 | M6 x 1.0 | 25 | 1 (0.5) |
| 76543-X02 | M6 x 1.0 | 250 | 6 (2.7) |
| 76543-X03 | M6 x 1.0 | 1000 | 23 (10.5) |
| 76544-X01 | 12-24 | 25 | 1 (0.5) |
| 76544-X02 | 12-24 | 250 | 6 (2.7) |
| 76545-X01 | 10-32 | 25 | 1 (0.5) |
| 76545-X02 | 10-32 | 250 | 6 (2.7) |
| 76545-X03 | 10-32 | 1000 | 23 (10.5) |

*X=*color: 0=Zinc, 7=Black Zinc

Lockable Storage Drawer

Drawer stores backup media, software, manuals, laptops, test equipment and extra patch cords in close proximity to the cabinet and is now stackable. Drawers are available for 19"W or 23"W racks and cabinets, and include attachment brackets that allow center mounting on two-post racks with 3" or 6"D (80 mm or 150 mm) equipment channels or front and rear attachment to four-post racks and cabinet systems (mounting rails must be adjusted between 24" and 39" (610 mm and 990 mm) in depth).

- Attaches to any CPI freestanding 19"W or 23"W rack or cabinet system
- Features 20"D (510 mm) lockable drawer that extends full depth for easy access to stored equipment
- Supports a 100 lb (45.4 kg) load (drawer and top surface combined)



Drawer with two-post mounting brackets



Drawer with four-post mounting brackets

| Part Number | Description H x W in (mm) | Shipping Weight lb (kg) |
|-------------|---------------------------|-------------------------|
| 13082-X19 | 19" x 2U Drawer, 20 (510) | 18 (8.2) |
| 13083-X19 | 19" x 3U Drawer, 20 (510) | 20 (9.1) |
| 13084-X19 | 19" x 4U Drawer, 20 (510) | 22 (10.0) |
| 13082-X23 | 23" x 2U Drawer, 20 (510) | 21 (9.5) |
| 13083-X23 | 23" x 3U Drawer, 20 (510) | 23 (10.4) |
| 13084-X23 | 23" x 4U Drawer, 20 (510) | 25 (11.3) |

*X=*color: 1=Gray, 2=Computer Beige, 5=Clear, 7=Black, E=Glacier White.



Fixed Shelf

Use fixed shelves to support equipment without rack-mounted brackets such as modems, CPUs, small power supplies and monitors. Shelves mount to the Universal EIA 5/8" - 5/8" - 1/2" (15.9 mm - 15.9 mm - 12.7 mm) alternating hole pattern of the four vertical mounting rails, and three depths are offered in 18", 24" and 29" (460 mm, 610 mm and 740 mm). Shelves have adjustable mounting depths of 13" to 24" (330 mm to 610 mm) for the 18" (460 mm) shelf, 17" to 28" (430 mm to 710 mm) for the 24" (610 mm) shelf and 24" to 38" (610 mm to 970 mm) for the 29" (740 mm) shelf.

- Made of strong, lightweight aluminum
- Installs using (8) #12-24 screws (not included)
- Supports up to 200 lb (90.7 kg)
- 19" shelves are UL Listed: File E227626; Category NWIN - Accessories



12336-XXX



14070-XXX

| Part Number | Description | Shipping Weight lb (kg) |
|-------------|----------------------------------|-------------------------|
| 12336-X19 | 19"W x 18"D (460 mm), Non-Vented | 7 (3.2) |
| 12337-X19 | 19"W x 18"D (460 mm), Vented | 7 (3.2) |
| 12334-X19 | 19"W x 24"D (610 mm), Non-Vented | 9 (4.1) |
| 12335-X19 | 19"W x 24"D (610 mm), Vented | 9 (4.1) |
| 14070-X19 | 19"W x 29"D (740 mm), Non-Vented | 11 (5.0) |
| 14072-X19 | 19"W x 29"D (740 mm), Vented | 10 (4.5) |
| 12336-X23 | 23"W x 18"D (460 mm), Non-Vented | 8 (3.6) |
| 12337-X23 | 23"W x 18"D (460 mm), Vented | 8 (3.6) |
| 12334-X23 | 23"W x 24"D (610 mm), Non-Vented | 10 (4.5) |
| 12335-X23 | 23"W x 24"D (610 mm), Vented | 10 (4.5) |
| 14070-X23 | 23"W x 29"D (740 mm), Non-Vented | 12 (5.4) |
| 14072-X23 | 23"W x 29"D (740 mm), Vented | 11 (5.0) |

X=Color: 1=Gray, 2=Computer Beige, 7=Black

Rack-Mount Cable Shelf

Use Rack-Mount Cable Shelf in any 19"W CPI cabinet equipped with an Air Dam Kit to provide a front-to-rear pathway for cables. Cables pass through brush-sealed ports along the front of the shelf. Rack-Mount Cable Shelf uses 1U and will fit in cabinets with mounting rails set between 22" and 40"D (560 mm and 1020 mm).



| Part Number | Description | Shipping Weight lb (kg) |
|-------------|----------------|-------------------------|
| 13517-701 | 1U x 19, Black | 17 (7.7) |

2U



Sliding Shelf

Shelves mount to the four vertical mounting rails. Two depths are offered in 18" and 24" (460 mm and 610 mm) to provide clearance for cables, ventilation and power strips. Shelves have adjustable mounting depths of 14" to 24" (360 mm to 610 mm) for the 18" (460 mm) shelf and 18" to 30" (460 mm to 760 mm) for the 24" (610 mm) shelf.

- Extends 17" (430 mm) for 18"D (460 mm) shelf and 23" (580 mm) for 24"D (610 mm)
- Offered in 18" (460 mm) or 24" (610 mm) depth, vented or non-vented
- Made of strong, lightweight aluminum
- Shelf locks in closed or fully open position, providing stability
- Ships fully assembled; installs using (8) #12-24 screws (not included)
- Fits cabinets that are 30"D (760 mm) or less
- Accommodates the Monitor Tie-Down Bracket, P/N 11725-X01
- Supports up to 140 lb (63.5 kg)

| Part Number | Description | Shipping Weight lb (kg) |
|-------------|----------------------------------|-------------------------|
| 12338-X19 | 19"W x 18"D (460 mm), Non-Vented | 7 (3.2) |
| 12339-X19 | 19"W x 18"D (460 mm), Vented | 7 (3.2) |
| 12345-X19 | 19"W x 24"D (610 mm), Non-Vented | 9 (4.1) |
| 12346-X19 | 19"W x 24"D (610 mm), Vented | 9 (4.1) |
| 12338-X23 | 23"W x 18"D (460 mm), Non-Vented | 8 (3.6) |
| 12339-X23 | 23"W x 18"D (460 mm), Vented | 8 (3.6) |
| 12345-X23 | 23"W x 24"D (610 mm), Non-Vented | 10 (4.5) |
| 12346-X23 | 23"W x 24"D (610 mm), Vented | 10 (4.5) |

X=Color: 1=Gray, 2=Computer Beige, 7=Black

1U



Shelf extends from 20"- 36" (510 mm - 910 mm) in depth. Mounting brackets included but not shown.

Low Profile Fixed Shelf

Unique telescoping design delivers between 20" and 36" (510 mm and 910 mm) of continuous support for up to 100 lbs (45.4 kg) of equipment in less than 1U of rack-mount space.

- Shelf bracket provides front and rear support, attaching with single screw to mounting rails
- Available in 19" EIA and 23" EIA widths, providing 17.5" and 21.5" (445 mm and 546 mm) surface space respectively
- Made of steel
- Supports up to 100 lb (45.4 kg)
- 19" shelves are UL Listed

| Part Number | Description | Shipping Weight lb (kg) |
|-------------|-------------------|-------------------------|
| 12573-X19 | 19"W Solid Shelf | 16 (7.3) |
| 12573-X23 | 23"W Solid Shelf | 18 (8.2) |
| 12610-X19 | 19"W Vented Shelf | 15 (6.8) |
| 12610-X23 | 23"W Vented Shelf | 17 (7.7) |

X=Color: 1=Gray, 2=Computer Beige, 7=Black

2U

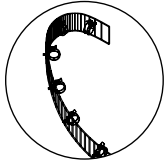
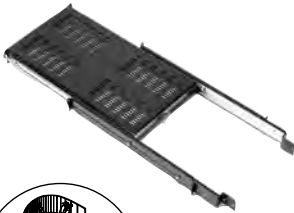

Flexible cable manager

32" Deep (810 mm) Sliding Shelf

Many storage solutions may cause kinking, twisting and cutting of cables during shelf extension and retraction. CPI's flexible polycarbonate belt, which fits in the rear undercarriage, solves these problems. This belt easily attaches to either the left or right side of the vertical bracket and contains eight molded releasable clips that accommodate cable bundles measuring up to 1" (25.4 mm) in diameter.

- Supports up to 160 lb (72.6 kg) using less than 2U
- Locks in the closed position
- Open easily with accessible front lock levers, providing greater stability while accommodating deep servers
- Maximum usable shelf space of up to 32" (810 mm)
- Cable management belt provides greater flexibility in the storage of wire bundles
- Designed for 36" or 39"D (910 mm or 990 mm) cabinets

| Part Number | Description | Shipping Weight lb (kg) |
|-------------|--|-------------------------|
| 11913-X19 | Vented, 19"W x 32"D (810 mm) Sliding Shelf | 25 (11.3) |
| 11914-X19 | Non-Vented, 19"W x 32"D (810 mm) Sliding Shelf | 25 (11.3) |
| 11913-X23 | Vented, 23"W x 32"D (810 mm) Sliding Shelf | 25 (11.3) |
| 11914-X23 | Non-Vented, 23"W x 32"D (810 mm) Sliding Shelf | 25 (11.3) |

X=Color: 1=Gray, 2=Computer Beige, 7=Black

2U



Patented shelf extends a full 24" (610 mm).

Extra Heavy Duty Sliding Shelf

Shelf supports up to 300 lb (136.1 kg) and uses only 2U, providing 26" (660 mm) usable depth.

- Flexible cable management belt eliminates kinking, bending or cutting of cable
- Adjustable mounting depth of 20" to 34" (510 mm to 860 mm)
- 19" shelf provides 17.5" (445 mm) usable width
- 23" shelf provides 21.5" (546 mm) usable width
- Locks in fully closed or open position

| Part Number | Description | Shipping Weight lb (kg) |
|-------------|------------------|-------------------------|
| 12700-X19 | 19"W Solid Shelf | 29 (13.2) |
| 12700-X23 | 23"W Solid Shelf | 30 (13.6) |

X=Color: 1=Gray, 2=Computer Beige, 7=Black, E=Glacier White



Aisle Containment Solutions

Aisle Containment Solutions by CPI utilize Passive Cooling® to create effective and efficient thermal solutions at every level of infrastructure deployment.

CPI's latest innovation in Aisle Containment has sharpened focus on total air isolation, resulting in a solution that helps reduce energy costs and optimizes power availability. The flexibility to deploy the containment system into the hot or cold aisle provides the ability to overcome facility challenges like limited ceiling height, complicated overhead pathways or the inability to add a drop ceiling or overhead return ducts. Frame Supported options support colocation facilities and roll in/roll out deployment, allowing cabinets to be added or omitted from contained aisles, while maintaining air isolation.

Currently available in these solutions:

- Build To Spec (BTS) Hot Aisle Containment (HAC)
- Cabinet Supported Cold Aisle Containment (CAC)

CPI Aisle Containment Solutions feature:

- Effectively utilize 100% of supplied air and reduce chilled air waste
- Improve CRAC efficiency because of the higher supply-to-return temperature differences
- Support 4x higher heat and power densities (6 kW to 30+ kW)
- Eliminate Hot Spots
- Allow increased room temperature, higher set points on cooling equipment and chilled water temperatures for more free cooling hours using low-cost economizers

PATENTED

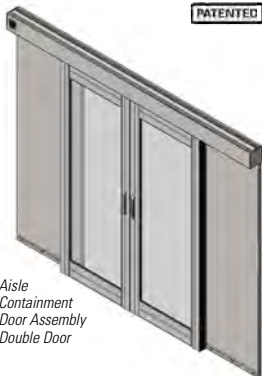

Aisle Containment Door Assembly Double Door

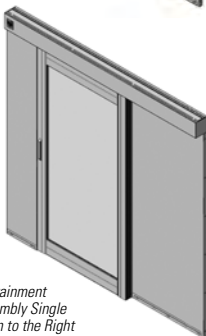

Aisle Containment Door Assembly Single Door, Open to the Right

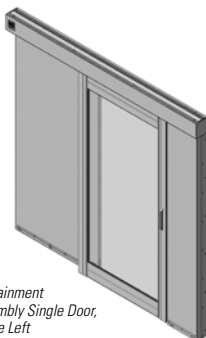

Aisle Containment Door Assembly Single Door, Open to the Left

Aisle Containment Door Assembly

Use with all CPI containment solutions. The door assembly encloses the end of an aisle between adjacent cabinet rows. Available in single- and double-door assemblies. Fits snugly against the cabinets, and features an integrated interior handle, full height vertical edge seals, height adjustable brush floor seals and a magnetic door seal. Automatic close system ensures maximum performance by minimizing airflow disruptions. Low-profile design conceals installation hardware.

- Door frames feature an integrated interior handle, full-height vertical-edge seals, height-adjustable brush floor seals and a magnetic door seal
- Automatic close system ensures maximum performance by minimizing airflow disruptions and includes a speed control damper for safe operation
- Detents open feature for easy access during extended service periods
- No threshold under the door when opened
- Low-profile design conceals floor installation hardware
- Door frames are anodized aluminum with a large, full-height, transparent polycarbonate window
- Door track is aluminum extrusion; end panels, cover and brackets are steel
- Not compatible with cabinets/frames less than 42"D (1050 mm) on 7 tile, 168" (4200 mm) pitch
- End panels are painted glacier white or black; option for paint matched door frames available

Dimensions (H x W x D), in (mm)

- For P/N 32770-XXX:
 - 1 size, assembly is 88.5"H x 106.9"W x 5.5"D (2248 mm x 2715 mm x 140 mm) with an 82"H x 42"W (2083 mm x 1067 mm) door opening
 - Spans 48"W to 72"W (1200 mm x 1800 mm) aisles (2 to 3 tiles)
- For P/N 32780-XXX:
 - 1 size, assembly is 88.5"H x 87.8"W x 5.4"D (2248 mm x 2231 mm x 137 mm) with an 82"H x 32"W (2083 mm x 810 mm) door opening
 - Spans 36"W to 48"W (910 mm x 1200 mm) aisles (1.5 to 2 tiles)
 - Retrofit solution for narrower 36" (910 mm) aisle clearance

| Aisle Containment Door Assembly | | |
|--|---------------|------------------------------------|
| Part Number & Finish | | Description |
| Black | Glacier White | |
| Double Door | | |
| 32770-701 | 32770-E01 | With Painted Door Frames |
| 32770-702 | 32770-E02 | With Anodized Aluminum Door Frames |
| Single Door, Opens To The Right | | |
| 32780-702 | 32780-E02 | With Painted Door Frames |
| 32780-704 | 32780-E04 | With Anodized Aluminum Door Frames |
| Single Door, Opens To The Left | | |
| 32780-701 | 32780-E01 | With Painted Door Frames |
| 32780-703 | 32780-E03 | With Anodized Aluminum Door Frames |

Notes: Double doors spans two to three tile aisles and has a 42"W (1067 mm) door opening. Single door is right or left opening, spans two tile aisles and has a 32"W (812 mm) door opening. Order one Floor Mounting Template for each site.

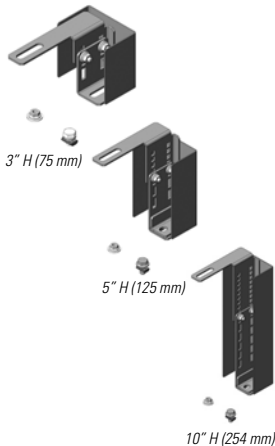

Door Mounting Bracket

Secures the Aisle Containment Door Assembly to the tops of the cabinets. Two versions for use with or without Door Standoff Kit (P/N 32870). Includes two brackets; available in three height ranges

| Aisle Containment Door Assembly | | |
|--|---------------|--|
| Part Number & Finish | | Description |
| Black | Glacier White | |
| Door Mounting Bracket Kit (use with Standoff Kit) | | |
| 32805-703 | 32805-E03 | 3"H (75 mm), For 85.3"H (2167 mm) to 91.4"H (2322 mm) Cabinets |
| 32805-704 | 32805-E04 | 5"H (125 mm), For 82.6"H (2098 mm) to 94.2"H (2393 mm) Cabinets |
| 32805-705 | 32805-E05 | 10"H (254 mm), For 77.8"H (1976 mm) to 98.9"H (2512 mm) Cabinets |
| 32780-704 | 32780-E04 | With Anodized Aluminum Door Frames |
| Door Mounting Bracket Kit (use without Standoff Kit) | | |
| 32805-700 | 32805-E00 | 3"H (75 mm), For 85.3"H (2167 mm) to 91.4"H (2322 mm) Cabinets |
| 32805-701 | 32805-E01 | 5"H (125 mm), For 82.6"H (2098 mm) to 94.2"H (2393 mm) Cabinets |
| 32805-702 | 32805-E02 | 10"H (254 mm), For 77.8"H (1976 mm) to 98.9"H (2512 mm) Cabinets |

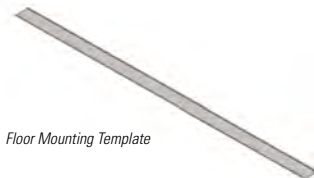

Floor Mounting Template

Provides a pattern for marking and drilling the floor when installing Aisle Containment Doors. Reusable, only one required.

| Aisle Containment Door Assembly | | |
|---------------------------------|--|-----------------------------------|
| Part Number & Finish | | Description |
| Black | | |
| 32875-701 | | For Aisle Containment Double-Door |
| 32875-702 | | For Aisle Containment Single Door |



Door Standoff Kit

Offsets door from the side of the cabinets, so floor mounting hardware is not located over the edges of the floor tiles. Provides approximately 2.5" (64 mm) standoff.

| Aisle Containment Door Assembly | | |
|---------------------------------|---------------|--------------------------------------|
| Part Number & Finish | | Description |
| Black | Glacier White | |
| 32870-701 | 32870-E01 | For Containment Double Door Assembly |
| 32870-702 | 32870-E02 | For Containment Single Door Assembly |

Door Top Seal Kit

Use with Cabinet Supported Solutions only. Flush mount and offset mount versions available in three size ranges. Seals the gap above the door when the door is attached to cabinets over 88" (2235 mm) tall.

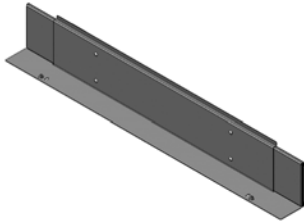

| Part Number & Finish | | Description |
|---|---------------|---|
| Black | Glacier White | |
| Door Top Seal Kit, For Use With Door Standoff Kit | | |
| 32817-704 | 32817-E04 | Adjusts from 48"W (1219 mm) to 59"W (1500 mm) |
| 32817-705 | 32817-E05 | Adjusts from 59"W (1500 mm) to 70"W (1775 mm) |
| 32817-706 | 32817-E06 | Adjusts from 70"W (1775 mm) to 81"W (2050 mm) |
| Door Top Seal Kit, For Use Without Door Standoff Kit | | |
| 32817-701 | 32817-E01 | Adjusts from 48"W (1219 mm) to 59"W (1500 mm) |
| 32817-702 | 32817-E02 | Adjusts from 59"W (1500 mm) to 70"W (1775 mm) |
| 32817-703 | 32817-E03 | Adjusts from 70"W (1775 mm) to 81"W (2050 mm) |

Containment Floor Seal Kit

Floor Seal Kits block bypass airflow underneath cabinets to prevent leakage from the contained aisle. Use one front seal kit on each cabinet and one side seal kit on each cabinet row, ordered separately.

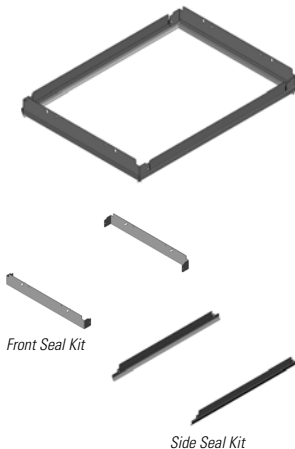

| Part Number & Finish | | Description |
|----------------------|---------------|--|
| Black | Glacier White | |
| 39208-700 | 39208-E00 | Front Seal, for 23.6"W (600 mm) Cabinets |
| 39208-701 | 39208-E01 | Front Seal, for 27.6"W (700 mm) Cabinets |
| 39208-703 | 39208-E03 | Front Seal, for 29.5"W (750 mm) Cabinets |
| 39208-702 | 39208-E02 | Front Seal, for 31.5"W (800 mm) Cabinets |
| 39209-700 | 39209-E00 | Side Seal, for 31.5"D (800 mm) Cabinets |
| 39209-708 | 39209-E01 | Side Seal, for 39.4"D (1000 mm) Cabinets |
| 39209-710 | 39209-E10 | Side Seal, for 41.3"D (1050 mm) Cabinets |
| 39209-712 | 39209-E12 | Side Seal, for 43.3"D (1100 mm) Cabinets |
| 39209-716 | 39209-E16 | Side Seal, for 47.2"D (1200 mm) Cabinets |

Note: The part numbers listed above are for GF-Series GlobalFrame Gen 2 Cabinets and F-Series TeraFrame Gen 3 Cabinets. Other sizes and styles are available. Contact CPI Technical Support for assistance.

PATENTED



Build To Spec (BTS) Hot Aisle Containment (HAC) Solution

The Build To Spec Kit Hot Aisle Containment (HAC) Solution features a field-fabricated duct that is used over a contained hot aisle as part of a closed hot air return. This solution integrates with perimeter cooling, provides immediate improved cooling efficiency and is compatible with economization methods. It is ideal for retrofit applications over a mix of cabinets, including cabinets of varying heights, widths and depths.

Solution Overview

- Field-fabricated duct accommodates site differences and existing conditions
- Compatible with a mix of cabinets – different heights, widths and depths in the same row
- Elevated, single-piece duct allows cabinets to be removed, omitted or replaced as required
- Translucent duct panels and transparent door panels allow light to enter the contained aisle
- Doors close automatically to maintain containment and reduce recovery time
- A complete solution maximizes performance with baffles to seal around and within the cabinets and contained aisle
- Durable construction and maintenance-free design provide many years of use

Containment Accessories:

- Floor Mounting Template

- 1 Build To Spec Kit (BTS) – Includes all of the components needed to construct a ceiling-supported or cabinet-supported duct to capture and direct airflow in the contained aisle. This design adapts to a mix of cabinets and allows cabinets to be changed when required. Used as part of a closed return for the air handling system.
- 2 Universal Bulb Seal – Edge seal used around drop panels to seal gaps above shorter cabinets. Bulb seal attaches directly to the edge of the panel.
- 3 Full-Height Cabinet Blanking Panel – Translucent panel and seal used to fill gaps where entire cabinets are omitted from the cabinet row or when adjacent cabinet rows are different lengths. Easy to install or remove in the field.
- 4 Aisle Containment Door Assembly – Sliding double doors (shown) or single door, both with automatic closing feature and large transparent panel(s). Doors attach to the cabinets at the ends of the aisle to seal the ends of the contained aisle.
- 5 Door Standoff Kit – Optional kit used when cabinets are placed over a raised floor to offset the door approximately 2.5" (64 mm).
- 6 Door Top Seal Kit (not shown) – Optional kit used when doors are shorter than cabinets to seal the gap between the top of the door and the top of the cabinets.
- 7 Door Mounting Bracket Kit (not shown) – Adjustable height brackets used to attach the Aisle Containment Door Assembly to the tops of cabinets.
- 8 Aisle Containment Cabinet to Floor Seal Kit – Cabinet-specific trim panels used along the base of cabinets to seal the gap between the floor and the bottom of the cabinet frame.

BTS Ordering Information

The specific combination of components needed to create a complete BTS Hot Aisle Containment (HAC) Solution will depend on a number of factors, including room layout, ceiling height and what types of cabinets models are selected.

To ensure you have a complete solution that addresses site- and cabinet-specific requirements, please contact CPI Technical Support for assistance developing a Bill of Materials (BOM).

Based on your input, CPI Technical Support will propose a complete solution with a drawing and detailed BOM. They will take the time to explain each selection, so you have a complete understanding of how CPI solutions will provide desired results.

| Example Bill Of Materials (BOM) | | | |
|---|-------------|---|-----|
| Item | Part Number | Description | Qty |
| BTS Hot Aisle Containment (HAC) Solution | | | |
| 1 | 33000-713 | BTS Kit, 96"H (2438 mm) x 96"W (2438 mm) x 282"L (7163 mm), Black | 1 |
| 2 | 33003-002 | Universal Bulb Seal, 96"L (2438 mm), Pack of 10 | 1 |
| 3 | 33002-701 | Full Height Cabinet Blanking Panel, 94"H (2387 mm) x 48"W (1219 mm), Pack of 2 | 1 |
| 4 | 32770-702 | Aisle Containment Double Door Assembly, Black with Anodized Door Frames | 2 |
| 5 | 32870-701 | Door Standoff Kit, for Double Door Assembly | 2 |
| 6 | 32817-706 | Door Top Seal Kit, For Use With Door Standoff Kit; 70"W (1775 mm) to 81"W (2050 mm) | 2 |
| 7 | 32805-703 | Door Mounting Bracket Kit, 3"H (75 mm) | 2 |
| 8 | 39208-700 | Cabinet To Floor Front Seal Kit, 23.6"W (600 mm) | 20 |
| | 39209-716 | Cabinet To Floor Side Seal Kit, 47.2"D (1200 mm) | 4 |
| Recommended Accessories | | | |
| | 32875-701 | Installation Template, Aisle Containment Double Door Assembly | 1 |
| | 34537-702 | Snap-In Filler Panel, 1U x 19"EIA, Black, Pack of 50 | 2 |
| | 34538-702 | Snap-In Filler Panel, 2U x 19"EIA, Black, Pack of 50 | 2 |
| | 13671-002 | Raised Floor Grommet, 10 Pack, Black | 2 |

For a more detailed analysis of your site, CPI offers a Pre-Installation Site Survey, a service where a CPI Technical Representative visits your site to provide a more detailed recommendation. To help ensure an optimized aisle containment installation, CPI offers On-Site Installation Supervision Services, which include related training and examination of the initial pods. Both Pre-Installation Site Surveys and On-Site Installation Supervision Support are especially important if there are special conditions, concerns or required customization.

All suggestions and performance statements are based on using an overall approach to airflow containment through the use of CPI products and solutions. For more information about CPI's Aisle Containment Services or products, call 800-834-4969, email techsupport@chatsworth.com or contact your Regional Sales Manager.

All products quoted are subject to availability based on manufacturing capacity, and shipping dates should be considered estimates only. While every effort has been made to ensure the accuracy of all information, CPI does not accept liability for any errors or omissions and reserves the right to change information and descriptions of listed services and products.



BTS Kit arrives on a pallet and includes eight unique components designed for easy installation and customization on-site.



BTS Kit assembled.

Notes:

- The BTS Kit includes the materials needed to create the duct over the cabinets and contained aisle.
- The duct should be slightly larger than the contained aisle; a minimum of 10" (250 mm) wider and 3" (75 mm) longer, so that it overlaps the adjacent cabinets.
- All containment packages come standard with adequate brackets to accommodate a ceiling- or cabinet-supported solution. Order ceiling or cabinet installation hardware separately.
- Doors, full-height cabinet blanking panels and additional materials for header/drop panels over cabinets must be ordered separately.

| Part Number & Finish | | BTS Kit | | | | | | Ref Row Length by # of Tiles |
|----------------------|---------------|-------------|------|-------|------|--------|--------|------------------------------|
| | | Description | | | | | | |
| | | Height | | Width | | Length | | |
| Black | Glacier White | in | mm | in | mm | in | mm | |
| 33000-701 | 33000-E01 | 48 | 1219 | 96 | 2438 | 94 | 2388 | 3 |
| 33000-702 | 33000-E02 | 48 | 1219 | 96 | 2438 | 188 | 4775 | 7 |
| 33000-703 | 33000-E03 | 48 | 1219 | 96 | 2438 | 282 | 7163 | 11 |
| 33000-704 | 33000-E04 | 48 | 1219 | 96 | 2438 | 376 | 9550 | 15 |
| 33000-705 | 33000-E05 | 48 | 1219 | 96 | 2438 | 470 | 11 938 | 19 |
| 33000-706 | 33000-E06 | 48 | 1219 | 96 | 2438 | 564 | 14 326 | 23 |
| 33000-707 | 33000-E07 | 48 | 1219 | 96 | 2438 | 658 | 16 713 | 27 |
| 33000-708 | 33000-E08 | 48 | 1219 | 96 | 2438 | 752 | 19 101 | 31 |
| 33000-709 | 33000-E09 | 48 | 1219 | 96 | 2438 | 846 | 21 488 | 35 |
| 33000-710 | 33000-E10 | 48 | 1219 | 96 | 2438 | 940 | 23 876 | 39 |
| 33000-711 | 33000-E11 | 96 | 2438 | 96 | 2438 | 94 | 2388 | 3 |
| 33000-712 | 33000-E12 | 96 | 2438 | 96 | 2438 | 188 | 4775 | 7 |
| 33000-713 | 33000-E13 | 96 | 2438 | 96 | 2438 | 282 | 7163 | 11 |
| 33000-714 | 33000-E14 | 96 | 2438 | 96 | 2438 | 376 | 9550 | 15 |
| 33000-715 | 33000-E15 | 96 | 2438 | 96 | 2438 | 470 | 11 938 | 19 |
| 33000-716 | 33000-E16 | 96 | 2438 | 96 | 2438 | 564 | 14 326 | 23 |
| 33000-717 | 33000-E17 | 96 | 2438 | 96 | 2438 | 658 | 16 713 | 27 |
| 33000-718 | 33000-E18 | 96 | 2438 | 96 | 2438 | 752 | 19 101 | 31 |
| 33000-719 | 33000-E19 | 96 | 2438 | 96 | 2438 | 846 | 21 488 | 35 |
| 33000-720 | 33000-E20 | 96 | 2438 | 96 | 2438 | 940 | 23 876 | 39 |
| 33000-721 | 33000-E21 | 48 | 1219 | 144 | 3658 | 94 | 2388 | 3 |
| 33000-722 | 33000-E22 | 48 | 1219 | 144 | 3658 | 188 | 4775 | 7 |
| 33000-723 | 33000-E23 | 48 | 1219 | 144 | 3658 | 282 | 7163 | 11 |
| 33000-724 | 33000-E24 | 48 | 1219 | 144 | 3658 | 376 | 9550 | 15 |
| 33000-725 | 33000-E25 | 48 | 1219 | 144 | 3658 | 470 | 11 938 | 19 |
| 33000-726 | 33000-E26 | 48 | 1219 | 144 | 3658 | 564 | 14 326 | 23 |
| 33000-727 | 33000-E27 | 48 | 1219 | 144 | 3658 | 658 | 16 713 | 27 |
| 33000-728 | 33000-E28 | 48 | 1219 | 144 | 3658 | 752 | 19 101 | 31 |
| 33000-729 | 33000-E29 | 48 | 1219 | 144 | 3658 | 846 | 21 488 | 35 |
| 33000-730 | 33000-E30 | 48 | 1219 | 144 | 3658 | 940 | 23 876 | 39 |
| 33000-731 | 33000-E31 | 96 | 2438 | 144 | 3658 | 94 | 2388 | 3 |
| 33000-732 | 33000-E32 | 96 | 2438 | 144 | 3658 | 188 | 4775 | 7 |
| 33000-733 | 33000-E33 | 96 | 2438 | 144 | 3658 | 282 | 7163 | 11 |
| 33000-734 | 33000-E34 | 96 | 2438 | 144 | 3658 | 376 | 9550 | 15 |
| 33000-735 | 33000-E35 | 96 | 2438 | 144 | 3658 | 470 | 11 938 | 19 |
| 33000-736 | 33000-E36 | 96 | 2438 | 144 | 3658 | 564 | 14 326 | 23 |
| 33000-737 | 33000-E37 | 96 | 2438 | 144 | 3658 | 658 | 16 713 | 27 |
| 33000-738 | 33000-E38 | 96 | 2438 | 144 | 3658 | 752 | 19 101 | 31 |
| 33000-739 | 33000-E39 | 96 | 2438 | 144 | 3658 | 846 | 21 488 | 35 |
| 33000-740 | 33000-E40 | 96 | 2438 | 144 | 3658 | 940 | 23 876 | 39 |



Universal Bulb Seal For BTS Kit

Edge seal that attaches to Polycarbonate Panel providing an edge seal for duct drop panels over cabinets. Trim length to match site requirements

- Includes: (2) or (10) each, 96" L (2387 mm) bulb seals
- Material: Plastic; bulb is flexible PVC (UL 94HB or UL 94V0), support is rigid PVC (UL 94V0), barbs in support are flexible Alcryn (UL 94HB)
- Flammability Standards: UL 94HB or UL 94V0
- Finish: Black

| Part Number | Description |
|-------------|---------------------------------|
| 33003-001 | 96" L (2438), Pack of 2, Black |
| 33003-002 | 96" L (2438), Pack of 10, Black |

Note: Use as an edge seal around drop panels over cabinets.



Full Height Cabinet Blanking Panel; BTS Kit

Fills gaps when a cabinet is omitted from the aisle/cabinet row. Fits snugly and contains air in the enclosed hot aisle between the sides of adjacent rows.

Center panel is translucent and sides are painted. Includes horizontal and vertical seals; order hardware separately.

- Includes: 0.23" (6 mm) thick, 48"W (1219 mm) x 96"L (2387 mm) translucent panels, Universal Bulb Seal and aluminum extrusion supports
- Material: polycarbonate sheet and aluminum extrusion
- Surface Burning Characteristics of panels: ASTME E-84 (UL-723) Flame Spread Index = 0, Smoke Developed Index <=85.
- Finish: clear (translucent); extrusions are painted

| Part Number & Finish | | Description |
|----------------------|---------------|---|
| Black | Glacier White | |
| 33002-701 | 33002-E01 | 94"H (2387 mm) x 48"W (1219 mm), Pack of 2 |
| 33002-702 | 33002-E02 | 94"H (2387 mm) x 48"W (1219 mm), Pack of 10 |

Note: Center panel is translucent, sides and brackets are painted.



Corrugated Flute Cutter For BTS Kit

The Corrugated Flute Cutter is the best cutting tool for trimming the width of the corrugated panels used with CPI's Hot Aisle Containment (HAC) Solutions.

- Ergonomic handle for easier cutting compared to utility knife
- Notched blade with guides for cutting along flutes in material
- Insert the guide into the panel flute and pull through material to cut to width

| Part Number | Description |
|-------------|---|
| 33001-001 | Corrugated Flute Cutter, 4 mm, Sold Each |
| 33001-002 | Corrugated Flute Cutter, 4 mm, Pack of 10 |



Cold Aisle Containment (CAC) Solutions

For information on CPI's CAC Solutions, please contact Tech Support at techsupport@chatsworth.com.



Wire Cage Enclosures

Wire Cage Enclosures create a security partition around your equipment in shared facility spaces such as Multitenant Data Centers (MTDC), colocation sites, entrance facilities and equipment rooms. Wire Cage Enclosures feature an open design made from a woven wire mesh that allows airflow to equipment, while providing physical security. CPI Wire Cage Enclosures are a simple, economical way to partition your space and secure your equipment.

Wire Cage Enclosures are comprised of several standard components including Modular Panels, Posts, Adjustable Panels, Doors and Door Locks. Each component is described below. Wire Cage Enclosures are available painted Black or Glacier White. Work with CPI Technical Support to create a unique solution, sized to match your specific site requirements.

Features:

- Easy configuration and ordering – Simply contact CPI Technical Support, and they will ask a series of questions about the size of the cage and preferred door size, style, location and lock. CPI will create a quote based on your described solution, and your order will ship as a complete kit under a single part number
- Complete partitions and security for your space and equipment – Provides physical security for your cabinets and equipment. A variety of locks are available to secure cage doors, and a ceiling can be added if required.
- Easy integration into the existing site – The open 2" x 1" rectangular mesh design allows free circulation of air to support the existing cooling system, lighting design and the fire suppression system within the secured area.

- Strong, secure and durable construction – Support posts have welded base plates that allow direct floor anchoring. Panels bolt directly to supportposts, utilizing the heaviest assembly hardware in the industry. All cage assembly hardware is inside the cage, so panels cannot be tampered with from the outside. Standard 3/8" wedge anchors hold partitions firmly in place.
- Modular design allows easy installation – The scalable, modular design allows the system to match site requirements. All components ship together as a complete kit. Posts and panels bolt together to form the cage. Self-drilling screws are used to attach doors. No cutting or grinding is required during installation. Assembly hardware is included and easily accessible from inside the frame.
- Matched finish for CPI Glacier White cabinets – Available in Glacier White finish to match your F-Series TeraFrame Gen 3 Cabinets, N-Series TeraFrame Gen 3 Network Cabinets and GF-Series GlobalFrame Gen 2 Cabinets in Glacier White.

Please contact CPI Technical Support for your Wire Cage Enclosure layout and pricing information. Simply email your layout information/drawing with the subject line "Wire Cage Enclosures" to techsupport@chatsworth.com, and include your contact information in the body of the email.

A CPI Representative will then contact you.



SECTION 2

CABLE MANAGEMENT PRODUCTS

| | | | |
|----------------------------------|------|--|------|
| Motive® Cable Management..... | 2-3 | Vertical Cable Management | 2-20 |
| Evolution® Cable Management..... | 2-10 | Global Standard Pack..... | 2-24 |
| Velocity® Cable Management..... | 2-16 | Universal Horizontal Cable Management..... | 2-29 |
| Velocity Standard Pack..... | 2-19 | Cable Management Accessories..... | 2-33 |

CABLE MANAGEMENT PRODUCTS

Section Update:

- Patented Motive® Cable Manager Page 2-3

Where Can I Learn More?

To learn more about CPI's Cable Management Products, or to find additional part numbers not listed in this catalog, please visit our website, chatsworth.com

Related Tools:

Use these tools, under the Resources tab on chatsworth.com, to simplify your planning, selection, order and purchase of CPI Cable Management Products.

- Visio Shapes
- CAD Blocks
- BIM Drawings
- Cable Fill
- MasterFormat Specs
- OSHPD Products

Your Notes Here:

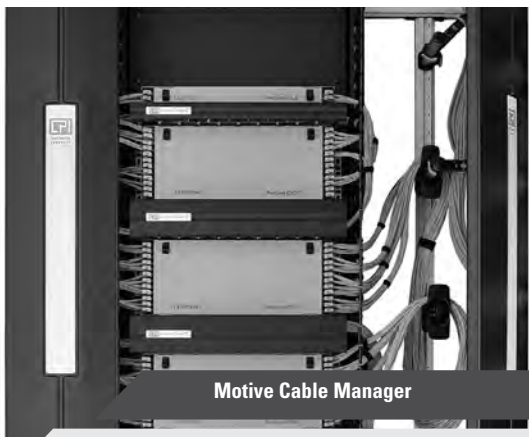

PATENTED



Motive Horizontal Cable Managers also available to complement the styling of the Motive Vertical Cable Managers. Please see page 2-9 for part number details.

Motive Cable Management

Motive Vertical Cable Manager is a highly configurable and advanced cable management solution that provides unlimited adjustability anywhere within the cable manager, optimizing use of interior space.

Motive Vertical Cable Management features an extrusion-based central track system and includes four tool-less cable management accessories. The unique design of the accessories provide numerous cable segregation configurations that allow for direct support of cables with optimal airflow through the cable manager, preparing networks for higher wattage in Power over Ethernet (PoE).

Tool-less Accessories in Motive Vertical Cable Manager include:

- Accessory Rod mounts to Motive's central track, feature tool-less vertical adjustment and serves as the foundation for all of Motive's cable management accessories
- Rotating Management Finger accessory attaches to the Accessory Rod and provides cable bundle support and bundle segregation at any point within the cable manager
- Cable Bundle Swivel accessory attaches directly to Motive's central track, Accessory Rod or Rotating Management Finger and allows for quick attachment, removal and adjustment of cable bundles
- Half Spool accessory snaps onto the Accessory Rod and provides slack management and bend support for cables

Whether in a small telecommunications room closet or in a large scale enterprise data center, Motive's superior form and functions provide quick and easy moves, add, and changes through intuitive design and tool-less adjustability.

Features:

- Frame has an extruded aluminum profile with a central track
- Innovative, tool-less accessories are included
- Large radii are designed into many of the frame elements to protect and support cables as they enter and exit the manager
- Touch points are highlighted in blue for easy identification and quick adjustment
- Dual-hinged door opens to the right or left and offers push-to-close convenience
- Hinge and latch design allows for quick removal and attachment of door for easy access to cables
- Hook feature on inside of front door provides a dedicated, secure location to hang a test meter
- Available in a wide variety of heights, widths and configurations

Motive Horizontal Cable Managers complements the styling of the Motive Vertical Cable Manager and provides a dedicated horizontal pathway to organize and store cables above patch panels and network switches.

- Available in four heights; 1U, 2U, 3U, 4U
- Contoured, snap-on front door opens up or down and complements the styling of Motive Vertical Cable Manager
- 2 chassis styles; solid or with cable pass-through ports
- Plastic T-shaped cable guides organize cables as they enter and exit the manager

Motive Ordering Matrix:

Choose Manager **Style**, **Width**, **Color**, and **Height**, **Example Cable Manager Part Number: 326XX-XXX**

| 3 | 2 | 6 | Style | Width - in (mm) | - | Color | Height - ft/in (m) |
|---|---|---|--------------|-----------------|---|-----------------|--------------------|
| | 1 | | Single-Sided | 0 6 (150) | | 7 Black | 01 6' (1.8) |
| | 2 | | Double-Sided | 1 8 (200) | | E Glacier White | 02 6'6" (2.0) |
| | | | | 2 10 (250) | | | 03 7' (2.1) |
| | | | | 3 12 (300) | | | 05 7'6" (2.3) |
| | | | | 4 15 (380) | | | 15 8' (2.4) |
| | | | | | | | 08 9' (2.7) |

Motive Vertical Cable Manager ships partially assembled.
 Assembly is quick and simple, requiring the installation of eight screws.

PATENTED



Accessories included with Motive Vertical Cable Manager:

Single-Sided Managers Include:

- Left and right side assemblies with T-shaped cable guides that align with rack-mount unit (U) spaces on rack
- Dual-hinged front door assembly
- Central track assembly
- 2 Accessory Rods
- 4 Rotating Management Fingers (Not included in 6"W (150 mm) and 8"W (200 mm))
- 12 Cable Bundle Swivels
- 4 Half Spools (Not included in 6"W (150 mm) and 8"W (200 mm))
- Installation and assembly hardware

Double-Sided Managers Include:

- Left and right side assemblies with T-shaped cable guides that align with rack-mount unit (U) spaces on rack
- Dual-hinged front door and rear door assemblies
- Central track assembly
- 4 Accessory Rods
- 4 Rotating Management Fingers (Not included in 6"W (150 mm) and 8"W (200 mm))
- 12 Cable Bundle Swivels
- 4 Half Spools (Not included in 6"W (150 mm) and 8"W (200 mm))
- Installation and assembly hardware

PATENTED



Accessory Rod Assembly

Accessory Rod Assembly hooks onto the central track at any point and features a T-slot extrusion on each side for attaching accessories and a thumb screw for quick adjustment.

- T-slot tracks on right and left sides
- Use for left and right cable segregation and with other accessories for a variety of configurations
- Adjust elevation by loosening and retightening of blue thumbscrew
- Sold in pairs
- Finish: Clear anodized aluminum with black base and end cap; blue adjustment point

| Part Number | Description | Shipping Weight lb (kg) |
|-------------|--|-------------------------|
| 32650-701 | For Motive Single-Sided Vertical Cable Manager, 1 pair | 2 (0.7) |
| 32650-702 | For Motive Double-Sided Vertical Cable Manager, 1 pair | 2 (0.7) |

See Cable Fill Tables at chatsworth.com/cablefill

PATENTED



Rotating Management Finger Kit

Rotating Management Finger Kit positions anywhere front-to-back along the Accessory Rod Assembly to secure and isolate cable bundles. It rotates and locks into position in 45 degree increments on the Accessory Rod Assembly for flexible cable support anywhere within the manager (Not for use with 6"W (150 mm) and 8"W (200 mm) managers).

- Attaches to the Accessory Rod using tool-less clasp-type fastener
- Accommodates up to 4 Cable Bundle Swivels
- Use for cable bundle segregation and to support cables anywhere within cable management space
- Sold in packs of 4
- Finish: Black with blue adjustment point

| Part Number | Description | Shipping Weight lb (kg) |
|-------------|---|-------------------------|
| 32661-001 | Rotating Management Finger Kit, Pack of 4 | 1 (0.5) |

PATENTED



Cable Bundle Swivel Kit

Cable Bundle Swivel Kit can be used anywhere on the central track or Accessory Rod Assembly, as well as multiple points on the Rotating Management Finger.

- Tool-less 1/4 turn installation
- Swivel feature adds flexibility and enhances cable bundle support
- Accommodates hook and loop fasteners up to 3/4"W (19 mm)
- Available in packs of 12 or 48
- Finish: Black with blue adjustment point

| Part Number | Description | Shipping Weight lb (kg) |
|-------------|-------------------------------------|-------------------------|
| 32657-001 | Cable Bundle Swivel Kit, Pack of 12 | 1 (0.5) |
| 32657-002 | Cable Bundle Swivel Kit, Pack of 48 | 2 (0.9) |

PATENTED



Half Spool Kit

Half Spool Kit attaches to the Accessory Rod Assembly. Half Spools can be used over and under to create a complete round spool or front/rear to create two half spools. (Not for use with 6"W (150 mm) and 8"W (200 mm) managers).

- Tool-less installation – snaps onto Accessory Rod Assembly
- Adjusts front-to-rear
- Installs on top and bottom of Accessory Rod Assembly to create a full 2" diameter (50 mm) spool
- Use up to 4 Half Spools per Accessory Rod Assembly
- Sold in a pack of 4
- Finish: Black

| Part Number | Description | Shipping Weight lb (kg) |
|-------------|---------------------------|-------------------------|
| 32651-001 | Half Spool Kit, Pack of 4 | 1 (0.5) |



Cable Ring Kit for Motive Single-Sided Vertical Cable Manager

- Creates a separate cable pathway for premise cables at the back of Motive Single-Sided Vertical Cable Manager
- Match the kit to the width of the vertical cable manager; one kit per manager
- Attaches to the central track with included hardware
- Rings are C-shaped, 3.5" H x 8.5" D (89 mm x 216 mm), with a plastic latch that spins open to provide access to cables
- Compatible with all Motive Cable Management accessories
- Each kit includes 5 rings

| Part Number | Description | Shipping Weight lb (kg) |
|-------------|---------------------------|-------------------------|
| 32573-X00 | For 6"W (150 mm) Manager | 9.6 (4.4) |
| 32573-X01 | For 8"W (200 mm) Manager | 11 (5.5) |
| 32573-X02 | For 10"W (250 mm) Manager | 12.4 (5.6) |
| 32573-X03 | For 12"W (300 mm) Manager | 14.8 (6.7) |
| 32573-X04 | For 15"W (380 mm) Manager | 17.8 (8.1) |

X= Color; 7 = Black, E= Glacier White.



Tool-less Bend Radius Kit for Fiber Patch Cords

Tool-less Bend Radius Kit for Fiber Patch Cords ensures proper bend radius support for fiber optic patch cords when transitioning through T-shaped cable guides. It snaps onto the finger manager without any tools, and can be used for new or retrofit applications.

- Provides proper bend radius support for fiber optic patch cords
- Tool-less installation
- May be installed in upward or downward orientations on either side of a T-shaped cable guide
- Compatible with Evolution, Motive Cable Management and N-Series TeraFrame Gen 3 Network Cabinet System.
- Also compatible with accessory cable management finder kits for SeismicFrame Two-Post Rack, Adjustable Rail QuadraRack and Adjustable Rail ServerRack (see P/N 13696-00X and 15286-0XX respectively)
- Available in packs of 10 or 50

| Part Number | Description | Shipping Weight lb (kg) |
|-------------|---|-------------------------|
| 32697-001 | Tool-less Bend Radius Kit for Fiber Patch Cords, Pack of 10 | 1 (0.5) |
| 32697-002 | Tool-less Bend Radius Kit for Fiber Patch Cords, Pack of 50 | 3 (1.4) |

PATENTED

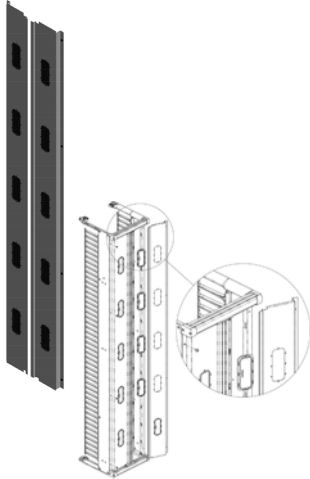

Rear Panel Kit for Motive Single-Sided Manager

- Use for added protection and/or in thermal containment environment
- Encloses the rear of the Motive Single-Sided Vertical Cable Manager
- Includes series of grommet-sealed openings in 10"W, 12"W and 15"W (250 mm, 300 mm, and 380 mm) managers
- Compatible with all other Motive Cable Manager accessories

| Part Number | Description | Shipping Weight lb (kg) |
|-------------|-----------------------------------|-------------------------|
| 32604-X03 | 84 (2133) for 6"W (150) Managers | 9 (4.1) |
| 32604-X09 | 84 (2133) for 8"W (200) Managers | 11 (5.0) |
| 32604-X15 | 84 (2133) for 10"W (250) Managers | 12 (5.5) |
| 32604-X21 | 84 (2133) for 12"W (300) Managers | 14 (6.4) |
| 32604-X27 | 84 (2133) for 15"W (380) Managers | 16 (7.3) |

X= Color; 7= Black, E= Glacier White. Rear Panel is available for all standard heights and widths. See Motive Data Sheet for additional information.

PATENTED

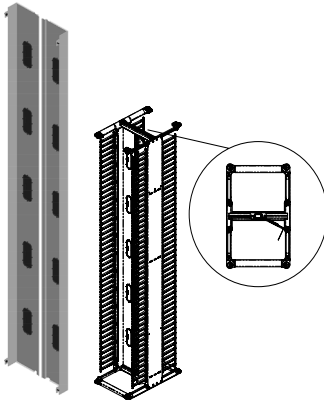

Mid Panel Kit for Motive Double-Sided Manager

- Use for added protection and/or in thermal containment environment
- Covers and divides the front and rear of the Motive Double-Sided Vertical Cable Manager
- Includes series of grommet-sealed openings in 10"W, 12"W and 15"W (250 mm, 300 mm, and 380 mm) managers
- Compatible with all other Motive Cable Manager accessories

| Part Number | Description | Shipping Weight lb (kg) |
|-------------|-----------------------------------|-------------------------|
| 32605-X03 | 84 (2133) for 6"W (150) Managers | 9 (4.1) |
| 32605-X09 | 84 (2133) for 8"W (200) Managers | 11 (5.0) |
| 32605-X15 | 84 (2133) for 10"W (250) Managers | 12 (5.5) |
| 32605-X21 | 84 (2133) for 12"W (300) Managers | 14 (6.4) |
| 32605-X27 | 84 (2133) for 15"W (380) Managers | 16 (7.3) |

X= Color; 7= Black, E= Glacier White. Mid Panel Kit is available for all standard heights and widths. See Motive Data Sheet for additional information.

PATENTED

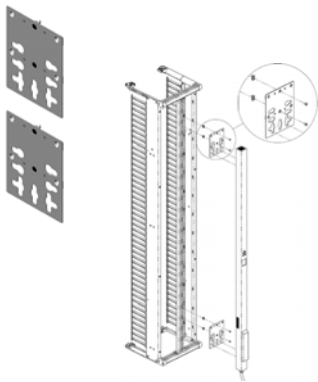

Dual PDU Bracket Kit

Dual PDU Bracket Kit attaches directly to Motive's central track and provides a flexible and convenient method of supporting up to two vertical PDUs side-by-side.

- 2-piece design enables compatibility with virtually all tool-less PDU chassis lengths
- Attaches directly to the central track of the manager
- Center-mount on any manager width
- Optional offset mount on 10"W (250 mm) and wider managers
- Supports two 2.7"W (69 mm) or narrower PDUs side-by-side or one 4"W (100 mm PDU)

| Part Number | Description | Shipping Weight lb (kg) |
|-------------|----------------------|-------------------------|
| 32601-X00 | Dual PDU Bracket Kit | 2 (0.9) |

X= Color; 7 = Black, E= Glacier White. (Note: Cable manager must be taller than PDU).

PATENTED

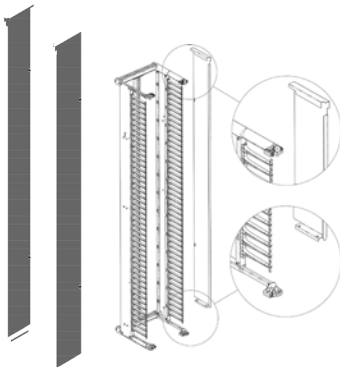

Side Panel Kit

- Use for added protection and/or in thermal containment environments
- Available in 1 pair or 2 pairs
- 1 pair includes 1 left and 1 right side panel and will cover both sides of a Motive Single-Sided Vertical Cable Manager
- 2 pairs includes 2 left and 2 right side panels and will cover both sides of a Motive Double-Sided Vertical Cable Manager

| Part Number | Description | Shipping Weight lb (kg) |
|-------------|--------------------|-------------------------|
| 32602-X03 | 84 (2133), 1 Pair | 16 (7.3) |
| 32602-X53 | 84 (2133), 2 Pairs | 30 (13.6) |

X= Color; 7 = Black, E= Glacier White. Side Panel Kit is available for all standard heights and widths. See Motive Data Sheet for additional information.

PATENTED



35431-X02



35432-X02

Motive Horizontal Cable Manager

Motive Horizontal Cable Manager complements the styling of the Motive Vertical Cable Manager and provides a dedicated horizontal pathway to organize and store cables above patch panels and network switches.

Motive Horizontal Cable Manager includes plastic T-shaped cable guides to organize patch cords and jumper cords as the cords enter and exit the manager to make individual equipment connections. Two chassis styles are available. Choose the solid chassis option for use in areas where thermal isolation is needed. Use the chassis with pass-through cable ports to allow patch cords to pass front-to-rear.

- Available in four heights; 1U, 2U, 3U, 4U
- Contoured, snap-on front door opens up or down and complements the styling of Motive Vertical Cable Manager
- 2 chassis styles; solid or with cable pass-through ports
- Plastic T-shaped cable guides organize cables as they enter and exit the manager

| Part Number | | Height (U) | Shipping Weight lb (kg) |
|-------------|-------------------------------|---------------------|----------------------------|
| Dual | Wide | | |
| 35431-X02 | With cable pass-through ports | 2U x 19 x 8.2 (208) | 4 (1.8) |
| 35431-X03 | With cable pass-through ports | 3U x 19 x 8.2 (208) | 5 (2.4) |
| 35431-X04 | With cable pass-through ports | 4U x 19 x 8.2 (208) | 7 (3.2) |
| 35432-X01 | Solid | 1U x 19 x 8.2 (208) | 3 (1.4) |
| 35432-X02 | Solid | 2U x 19 x 8.2 (208) | 4 (1.8) |
| 35432-X03 | Solid | 3U x 19 x 8.2 (208) | 5 (2.4) |
| 35432-X04 | Solid | 4U x 19 x 8.2 (208) | 7 (3.2) |

X=Color, 7=Black and E=Glacier White. 1U Horizontal managers available with solid chassis only.

See Cable Fill Tables at
chatsworth.com/cablefill

For Additional Part Numbers: chatsworth.com

PATENTED

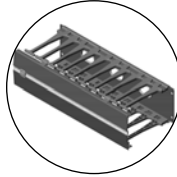
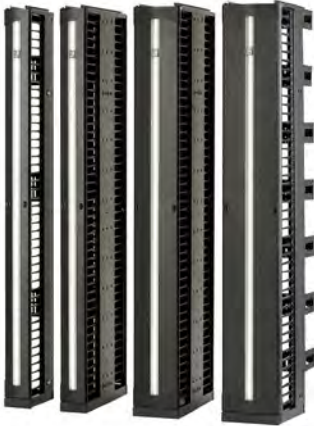

Evolution Horizontal Cable Managers also available to complement the styling of the Motive Vertical Cable Managers. Please see page 2-15 for part number details.

Evolution Cable Management

CPI Evolution Cable Management provides an engineered solution for managing high-density cabling applications on open two-post and four-post CPI Rack Systems.

Evolution Vertical Cable Manager:

Use vertical managers on the sides of racks to manage premise cables, patch cords and jumper cords. Vertical managers include plastic T-shaped cable guides with openings that align with each rack-mount unit space on the rack. Rounded edges on the cable guides and the top of the manager protect cables as they enter or exit the interior storage space. On double-sided managers, Movable Mid-Sections allow personalized placement of Cable Distribution Spools and other cable management accessories to effectively route patch cords.

Features:

- Improved T-shaped cable guides decrease deflection when loaded with cables, especially important when deploying Cat 6a cable
- Rounded edges on the cable guides protect cables as they enter and exit the storage space
- Door opens to the right or left with a single knob
- Rigid trough minimizes movement when installed on the end of a row of racks; solid construction with a full rectangular base supports large bundles of heavy cables
- Openings in the back of the single-sided and middle of the double-sided managers allow cables to easily pass from front-to-rear
- Double-sided managers have Movable Mid-Sections that allow for flexibility in the volume of cable management space provided in the front and rear portions of the cable manager
- Various cable management accessories are available to divide the interior space and manage cable slack

PATENTED



Single-Sided
Vertical Cable
Manager also
available in 6'H
(1.8 m) and
8'H (2.4 m)

Evolution g1 Single-Sided Vertical Cable Manager

- Rigid cable manager with 1U spaced plastic T-shaped cable guides (fingers)
- Three Fixed Accessory Panels at the back of the cable manager
- Three large Cable Distribution Spools included with 10", 12" and 15" (250 mm, 300 mm and 380 mm) wide managers

| Part Number | | 7'H (2.1 m) W x D - in (mm) | Shipping Weight lb (kg) |
|-------------|---------------|--------------------------------|-------------------------------|
| Black | Glacier White | | |
| 35511-703 | 35511-E03 | 6 x 13.2 (150 x 335) | 57 (25.9) |
| 35512-703 | 35512-E03 | 8 x 13.2 (200 x 335) | 61 (27.7) |
| 35513-703 | 35513-E03 | 10 x 13.2 (250 x 335) | 67 (30.4) |
| 35514-703 | 35514-E03 | 12 x 13.2 (300 x 335) | 73 (33.1) |
| 35515-703 | 35515-E03 | 15 x 13.2 (380 x 335) | 83 (37.6) |

PATENTED



Double-Sided
Vertical Cable
Manager also
available in 6'H
(1.8 m) and
8'H (2.4 m)

Evolution g2 Double-Sided Vertical Cable Manager

- Rigid cable manager with 1U spaced plastic T-shaped cable guides (fingers)
- Three Movable Mid-Sections; creates 50/50, 60/40 or 40/60 interior split
- Three large Cable Distribution Spools included with 10", 12" and 15" (250 mm, 300 mm and 380 mm) wide managers

| Part Number | | 7'H (2.1 m) W x D - in (mm) | Shipping Weight lb (kg) |
|-------------|---------------|--------------------------------|-------------------------------|
| Black | Glacier White | | |
| 35521-703 | 35521-E03 | 6 x 24.5 (150 x 622) | 94 (42.6) |
| 35522-703 | 35522-E03 | 8 x 24.5 (200 x 622) | 101 (45.8) |
| 35523-703 | 35523-E03 | 10 x 24.5 (250 x 622) | 110 (49.9) |
| 35524-703 | 35524-E03 | 12 x 24.5 (300 x 622) | 118 (53.5) |
| 35525-703 | 35525-E03 | 15 x 24.5 (380 x 622) | 129 (58.5) |

PATENTED



Combination
Vertical Cable
Manager also
available in 6'H
(1.8 m) and
8'H (2.4 m)

Evolution g3 Combination Vertical Cable Manager

Rear Cable Rings with spin-open latches on back (no door/cover)

- Three large Cable Distribution Spools included with 10", 12" and 15" (250 mm, 300 mm and 380 mm) wide managers

| Part Number | | 7'H (2.1 m) W x D - in (mm) | Shipping Weight lb (kg) |
|-------------|---------------|--------------------------------|-------------------------------|
| Black | Glacier White | | |
| 35571-703 | 35571-E03 | 6 x 20.2 (150 x 513) | 68 (30.8) |
| 35572-703 | 35572-E03 | 8 x 20.2 (200 x 513) | 72 (32.7) |
| 35573-703 | 35573-E03 | 10 x 20.2 (250 x 513) | 78 (35.4) |
| 35574-703 | 35574-E03 | 12 x 20.2 (300 x 513) | 84 (38.1) |
| 35575-703 | 35575-E03 | 15 x 20.2 (380 x 513) | 94 (42.6) |

Evolution Cable Management Accessories

Fiber Segregation Kit

Creates a pathway for fiber cables and patch cords; the number of kits allowed per manager depends on the position of the Movable Mid-Section and the width of the vertical cable manager (see table). Each kit includes two 20.5"H (521 mm) J-shaped steel mounting brackets, eight plastic Fiber Segregation Spools and mounting hardware. The Fiber Segregation Spools turn 360° with stops at 90°, allowing easy access to fiber cables. The assembled bracket is 3.8"W x 4.3"D (97 mm x 109 mm) and includes mounting hardware.

| Cable Manager Width- in (mm) | Double-Sided with 60/40 Front/Rear Split (60% per side) | Single-Sided and all other Double-Sided positions |
|------------------------------|---|---|
| 6 (150) | 1 | 0 |
| 8 (200) | 1 | 1 |
| 10 (250) | 2 | 1 |
| 12 (300) | 2 | 2 |
| 15 (380) | 2 | 2 |

Cable Lashing Bar Kit

Provides tie points for cables inside Evolution Vertical Managers. Use up to six cable lashing bars (front/rear) in 6"W (150 mm) vertical cable managers and up to ten (front/rear) in the 8"W (200 mm), 10"W (250 mm), 12"W (300 mm) and 15"W (380 mm) vertical cable managers. Each kit includes four round .23" (5.7 mm) diameter 20.6"L (524 mm) steel lashing bars and mounting hardware.

Cable Divider Bar Kit

Provides tie points for cables and divides the interior of the cable manager to create multiple pathways for cables. Each kit includes four Cable Divider Bars, 5.75"H x 1"W x 20"L (146 mm x 25 mm x 510 mm) and mounting hardware. Divider Bars are welded steel construction consisting of a vertical cable lashing bar and two U-shaped cable dividers. Use side-by-side to create multiple pathways in 10"W (250 mm) or wider cable managers.

Tool-less Bend Radius Kit for Fiber Patch Cords

Ensures proper bend radius support for fiber optic patch cords when transitioning through T-shaped cable guides. It snaps onto the finger manager without any tools, and can be used for new or retrofit applications.

- Compatible with Evolution, Motive Cable Management and N-Series TeraFrame Gen 3 Network Cabinet System.
- Also compatible with accessory cable management finger kits for SeismicFrame Two-Post Rack, Adjustable Rail QuadraRack and Adjustable Rail ServerRack see P/N 13696-00X and 15286-0XX, respectively)

| Part Number | Description | Shipping Weight lb (kg) |
|-------------|---------------------------------------|-------------------------|
| 35475-701 | Fiber Segregation Kit, Black | 6 (2.7) |
| 35473-001 | Cable Lashing Bar Kit, Zinc | 2 (0.9) |
| 35503-701 | Cable Divider Bar Kit, Black | 3 (1.4) |
| 32697-001 | Tool-less Bend Radius Kit, Pack of 10 | 1 (0.5) |
| 32697-002 | Tool-less Bend Radius Kit, Pack of 50 | 3 (1.4) |

PATENTED



35475-701

PATENTED



35473-001

PATENTED



35503-701

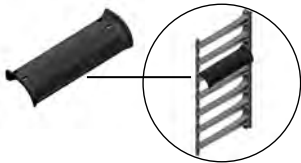

32697-701

See Cable Fill Tables at chatsworth.com/cablefill

PATENTED



35501-X02

Evolution Cable Management Accessories

Solid Rear Panel

Encloses the rear of the Evolution g1 Single-Sided Vertical Cable Manager. Hangs from the top of the manager or attaches to the back of the Fixed Accessory Panels. Sold individually or in pairs; includes hardware.

Solid Mid Panel

Covers and divides the front and rear of the Evolution g2 Double-Sided Vertical Cable Manager. Attaches to the back of the Movable Mid-Sections inside the manager. Includes one Moveable Mid-Section for 7'H (2.1m) manager and two for 8'H (1.8 m) manager. Sold individually or in packs of four; includes hardware.

Solid Side Panel

Covers the side of an Evolution g2 Double-Sided Vertical Cable Manager located at the end of a row of equipment racks. Easy tool-less installation; hangs from the top of the manager and attaches at the bottom of the manager with included snap-in hardware. Sold individually or in pairs.

PATENTED

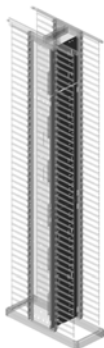

35497-X02

PATENTED



35502-X02

| Part Number | Description Height - 7'H (2.1 m) Width - in (mm) | Shipping Weight lb (kg) |
|-------------|--|----------------------------|
| 35501-X02 | Solid Rear Panel, 6 (150), Each | 11 (5.0) |
| 35501-X05 | Solid Rear Panel, 8 (200), Each | 11 (5.0) |
| 35501-X08 | Solid Rear Panel, 10 (250), Each | 11 (5.0) |
| 35501-X11 | Solid Rear Panel, 12 (300), Each | 11 (5.0) |
| 35501-X14 | Solid Rear Panel, 15 (380), Each | 11 (5.0) |
| 35501-X52 | Solid Rear Panel, 6 (150), Pair | 42 (19.1) |
| 35501-X55 | Solid Rear Panel, 8 (200), Pair | 42 (19.1) |
| 35501-X58 | Solid Rear Panel, 10 (250), Pair | 42 (19.1) |
| 35501-X61 | Solid Rear Panel, 12 (300), Pair | 42 (19.1) |
| 35501-X64 | Solid Rear Panel, 15 (380), Pair | 42 (19.1) |
| 35497-X02 | Solid Mid Panel, 6 (150), Each | 16 (7.3) |
| 35497-X05 | Solid Mid Panel, 8 (200), Each | 16 (7.3) |
| 35497-X08 | Solid Mid Panel, 10 (250), Each | 16 (7.3) |
| 35497-X11 | Solid Mid Panel, 12 (300), Each | 16 (7.3) |
| 35497-X14 | Solid Mid Panel, 15 (380), Each | 16 (7.3) |
| 35497-X52 | Solid Mid Panel, 6 (150), Pack of 4 | 62 (28.1) |
| 35497-X55 | Solid Mid Panel, 8 (200), Pack of 4 | 62 (28.1) |
| 35497-X58 | Solid Mid Panel, 10 (250), Pack of 4 | 62 (28.1) |
| 35497-X61 | Solid Mid Panel, 12 (300), Pack of 4 | 62 (28.1) |
| 35497-X64 | Solid Mid Panel, 15 (380) Pack of 4 | 62 (28.1) |
| 35502-X02 | Solid Side Panel, Each | 19 (8.6) |
| 35502-X52 | Solid Side Panel, Pair | 35 (15.9) |

X=Color; 7=Black, E=Glacier White. Accessories are also available in both 6' (1.8) and 8' (2.4) heights.

Evolution Cable Management Accessories

Fixed Accessory Panel Kit for Evolution g1 Single-Sided Manager

Kit includes three Fixed Accessory Panels for the Evolution g1 Single-Sided Vertical Cable Manager. Select to match the width of the cable manager; includes installation hardware.

Movable Mid-Section Kit for Evolution g2 Double-Sided Manager

Kit includes three Movable Mid-Sections for the Evolution g2 Double-Sided Vertical Cable Manager. Select to match the width; includes installation hardware.

Cable Distribution Spools

Attaches inside vertical cable managers. Spools are 2.75" (69.9 mm) in diameter and 5.9"L (150 mm) and made from black plastic; each kit includes four spools and mounting hardware. Three large cable distribution spools are included with each 10", 12" and 15" wide (250 mm, 300 mm and 380 mm) vertical cable manager (will not fit other sizes).

Cable Distribution Spool Spacer Kit

Spool Spacer Kit is used to offset the spool, so the front edge of the spool is close to the front edge of cable management fingers in the Evolution g2 Double-Sided Cable Managers. Use in 10", 12" and 15"W (250 mm, 300 mm and 380 mm) managers; includes three spools and three spacers. Attaches to the Movable Mid-Sections. Spacers are 2.8" (71 mm) in diameter, 2.5"H (64 mm) and made from black plastic; each kit includes eight spacers and mounting hardware.

Floor Bracket

Floor Bracket secures the base of the Evolution Vertical Managers to the floor when located at the end of a row of equipment racks. Light-duty, steel bracket with attachment hole sized for 1/4" hardware; packs of 12, order separately.

| Part Number | Description Width - in (mm) | Shipping Weight lb (kg) |
|----------------------------------|---|----------------------------|
| Fixed Accessory Panel Kit | | |
| 35492-X01 | For 6 (150) Evolution g1 Single-Sided | 3 (1.4) |
| 35492-X02 | For 8 (200) Evolution g1 Single-Sided | 4 (1.8) |
| 35492-X03 | For 10 (250) Evolution g1 Single-Sided | 5 (2.3) |
| 35492-X04 | For 12 (300) Evolution g1 Single-Sided | 6 (2.7) |
| 35492-X05 | For 15 (380) Evolution g1 Single-Sided | 7 (3.2) |
| Movable Mid Section Kit | | |
| 35493-X01 | For 6 (150) Evolution g2 Double-Sided | 4 (1.8) |
| 35493-X02 | For 8 (200) Evolution g2 Double-Sided | 5 (2.3) |
| 35493-X03 | For 10 (250) Evolution g2 Double-Sided | 5 (2.3) |
| 35493-X04 | For 12 (300) Evolution g2 Double-Sided | 7 (3.2) |
| 35493-X05 | For 15 (380) Evolution g2 Double-Sided | 8 (3.6) |
| 15008-001 | Cable Distribution Spools, Pack of 4, Black | 2 (0.9) |
| 35505-001 | Cable Distribution Spool Spacer Kit, Black | 1 (0.5) |
| 35506-701 | Floor Bracket, Black | 3 (1.4) |

X=Color, 7=Black, E=Glacier White.

PATENTED

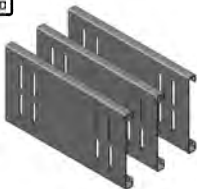

35492-X02

PATENTED



35493-X02



15008-001



35505-001

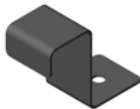

35506-701

Evolution Horizontal Cable Manager

Evolution Horizontal Cable Managers complements the styling of the Evolution Vertical Cable Manager and provides a dedicated horizontal pathway to organize and store cables above patch panels and network switches.

Evolution Horizontal Cable Manager includes plastic T-shaped cable guides to organize patch cords and jumper cords as the cords enter and exit the manager to make individual equipment connections. Two chassis styles are available. Choose the solid chassis option for use in areas where thermal isolation is needed. Use the chassis with pass-through cable ports to allow patch cords to pass front-to-rear.

- Available in four heights; 1U, 2U, 3U, 4U
- Contoured, snap-on front door opens up or down and complements the styling of Evolution Vertical Cable Manager
- 2 chassis styles; solid or with cable pass-through ports
- Plastic T-shaped cable guides organize cables as they enter and exit the manager



35442-X03



35441-X03

| Part Number | Chassis Style | Description H x W x D in (mm) | Shipping Weight lb (kg) |
|-------------|-------------------------------|-------------------------------------|-------------------------------|
| 35441-X01 | Solid | 1U x 19 x 8.2 (208) | 4 (1.8) |
| 35442-X02 | Solid | 2U x 19 x 8.2 (208) | 5 (2.3) |
| 35442-X03 | Solid | 3U x 19 x 8.2 (208) | 6 (2.7) |
| 35442-X04 | Solid | 4U x 19 x 8.2 (208) | 7 (3.2) |
| 35441-702 | With cable pass-through ports | 2U x 19 x 8.2 (208) | 4 (1.8) |
| 35441-703 | With cable pass-through ports | 3U x 19 x 8.2 (208) | 5 (2.4) |
| 35441-704 | With cable pass-through ports | 4U x 19 x 8.2 (208) | 7 (3.2) |

*X=Color, 7=Black and E=Glacier White. *1U Horizontal managers available with solid chassis only.*

See Cable Fill Tables at
chatsworth.com/cablefill

For Additional Part Numbers: chatsworth.com

PATENTED

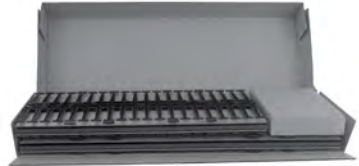

Velocity Cable Managers are easy to ship and store. Compact packaging requires less storage space, reduces waste and is easier and more cost-efficient to ship.

Velocity Cable Management

CPI's Velocity Cable Management is an economical cable management solution for everyday use in telecommunication rooms, equipment rooms and lab spaces, and creates a complete vertical and horizontal pathway for premise cabling and patch cords on CPI Rack Systems.

Vertical Cable Managers:

Velocity Cable Management includes single- and double-sided vertical cable managers available in four widths and three heights. They can ship unassembled in compact packaging to reduce shipping costs and storage space, providing easier staging and handling on the job site with less packaging to remove. No tools are required to assemble the cable manager. The components simply snap together, and the manager bolts to the side of the rack with included hardware.

The vertical cable manager features a large cross section to maximize internal cable management space. To simplify cable management, T-shaped cable guides and openings on the sides of the manager align with each rack-mount unit and have rounded edges to protect cables from snags. Snap-on covers are included and swing open to the right or left to provide easy access, and protect cables when closed. The manager has openings in the body, which allow cables to easily pass from front-to-rear. Add the accessory Cable Spool Kit to manage fiber, the Cable Lashing Bar Kit to secure large cable bundles or the Cable Ring Kit to create a rear pathway on the back of single-sided managers.

Features:

- Vertical managers for open two-post and four-post CPI Rack Systems that have 3"D (80 mm) mounting channels; do not use with 6" Deep Standard Rack or SeismicFrame Two-Post Rack
- Packaging:
 - Each vertical cable manager ships unassembled in a single carton
 - Each horizontal cable manager ships fully assembled in a single carton
- Material:
 - Vertical cable manager has steel mid panels, splice plates and plastic sides; covers on 3.6"W (91 mm) and 6"W (152 mm) managers are plastic; covers on 10"W (254 mm) and 12"W (305 mm) managers are steel with plastic hinges
 - Horizontal cable manager is plastic
- Finish: Black epoxy-polyester hybrid powder coat paint on steel parts; black plastic

Tool-less, click together assembly:

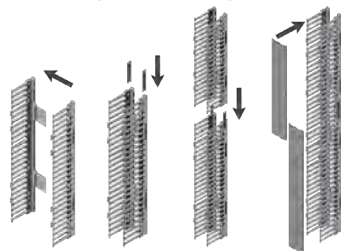

PATENTED



Note: 3.6" W & 6" W ship with extruded plastic doors; 10" W & 12" W ship with metal doors.

Velocity Single-Sided Vertical Cable Managers are 9.5" D (241 mm) without doors. The overall depth listed in the order table varies due to the bevel on the door, which differs slightly with width. Usable depth is 7.5" (191 mm). Usable width is 1.3" (33 mm) less than overall width.

Velocity Single-Sided Vertical Cable Managers

(4) vertical side sections with T-shaped cable guides spaced 1U apart; (4) mid panels with attachment points for cable management accessories; (2) splice plates used to assemble the top and bottom side sections; (2) half-height covers that snap onto the T-shaped cable guides; (8) M8 hex bolts, washers and hex flange nuts to secure cable managers to the rack

| Part Number | Height ft (m) | Description H x W x D in (mm) | Shipping Weight lb (kg) |
|-------------|-----------------------------|-------------------------------------|-------------------------|
| 13901-701 | 6'H (1.8 m) 38U Racks | 70 x 3.6 x 9.7 (1778 x 91 x 246) | 17 (7.7) |
| 13902-701 | | 70 x 6 x 9.8 (1778 x 152 x 249) | 18 (8.2) |
| 13904-701 | | 70 x 10 x 10.3 (1778 x 254 x 262) | 30 (13.6) |
| 13905-701 | 7'H (2.1 m) 45U Racks | 70 x 12 x 10.4 (1778 x 305 x 264) | 32 (14.5) |
| 13901-703 | | 80.5 x 3.6 x 9.7 (2045 x 91 x 246) | 18 (8.2) |
| 13902-703 | | 80.5 x 6 x 9.8 (2045 x 152 x 249) | 20 (9.1) |
| 13904-703 | | 80.5 x 10 x 10.3 (2045 x 254 x 262) | 32 (14.5) |
| 13905-703 | 8'H (2.4 m) 51/52U Racks | 80.5 x 12 x 10.4 (2045 x 305 x 264) | 34 (15.4) |
| 13901-715 | | 91 x 3.6 x 9.7 (2311 x 91 x 246) | 19 (8.6) |
| 13902-715 | | 91 x 6 x 9.8 (2311 x 152 x 249) | 21 (9.5) |
| 13904-715 | | 91 x 10 x 10.3 (2311 x 254 x 262) | 34 (15.4) |
| 13905-715 | | 91 x 12 x 10.4 (2311 x 305 x 264) | 36 (16.3) |

Color is black.

PATENTED



Note: 3.6" W & 6" W ship with extruded plastic doors; 10" W & 12" W ship with metal doors.

Velocity Double-Sided Vertical Cable Managers are 16" D (406 mm) without doors. The overall depth listed in the order table varies due to the bevel on the door, which differs slightly with width. Usable depth in the front of the manager is 7.5" (191 mm). Usable depth at the rear of the manager is 5.5" (140 mm). Usable width is 1.3" (33 mm) less than overall width.

Velocity Double-Sided Vertical Cable Manager

(4) vertical side sections with T-shaped cable guides spaced 1U apart; (4) mid panels with attachment points for cable management Accessories; (2) splice plates used to assemble the top and bottom side sections; (4) half-height covers that snap onto the T-shaped cable guides; (8) M8 hex bolts, washers and hex flange nuts to secure cable managers to the rack

| Part Number | Height ft (m) | Description H x W x D in (mm) | Shipping Weight lb (kg) |
|-------------|-----------------------------|-------------------------------------|-------------------------|
| 13911-701 | 6'H (1.8 m) 38U Racks | 70 x 3.6 x 16.4 (1778 x 91 x 417) | 23 (10.4) |
| 13912-701 | | 70 x 6 x 16.6 (1778 x 152 x 422) | 26 (11.8) |
| 13914-701 | | 70 x 10 x 17.5 (1778 x 254 x 445) | 37 (16.8) |
| 13915-701 | 7'H (2.1 m) 45U Racks | 70 x 12 x 17.8 (1778 x 305 x 446) | 40 (18.1) |
| 13911-703 | | 80.5 x 3.6 x 16.4 (2045 x 91 x 417) | 25 (11.3) |
| 13912-703 | | 80.5 x 6 x 16.6 (2045 x 152 x 422) | 28 (12.7) |
| 13914-703 | | 80.5 x 10 x 17.5 (2045 x 254 x 445) | 40 (18.1) |
| 13915-703 | 8'H (2.4 m) 51/52U Racks | 80.5 x 12 x 17.8 (2045 x 305 x 446) | 43 (19.5) |
| 13911-715 | | 91 x 3.6 x 16.4 (2311 x 91 x 417) | 27 (12.2) |
| 13912-715 | | 91 x 6 x 16.6 (2311 x 152 x 422) | 30 (13.6) |
| 13914-715 | | 91 x 10 x 17.5 (2311 x 254 x 445) | 44 (20.0) |
| 13915-715 | | 91 x 12 x 17.8 (2311 x 305 x 464) | 47 (21.3) |

Color is black.

Velocity Cable Management Accessories

Cable Ring Kit

Attaches to the sides with included hardware. Match the kit to the width and height of the vertical cable managers; one kit per manager. Rings are C-shaped, 3.0"H x 7.7"D (76 mm x 196 mm), made from aluminum and painted black; latch is black plastic and spins open to provide access to cables. Cable opening on 3.6"W (91 mm) rings is 1.4"W (36 mm); cable opening on other rings is 3.8"W (97 mm). Each kit includes multiple rings and mounting hardware. The kit for 6' (1.8 m) includes six rings, the kit for 7' (2.1 m) includes seven rings, and the kit for the 8' (2.4 m) includes eight rings.

13934-7XX

Cable Spool Kit

Attaches to the mid panel with included hardware. Use in 6"W (152 mm) or wider vertical cable managers; one kit per side. Spools are 2" (51 mm) in diameter and 6"W (152 mm) and made from aluminum; painted black. Each kit includes four spools and mounting hardware.

Cable Lashing Bar Kit

Provides tie points for cables inside Velocity Vertical Cable Managers. Attaches to the mid panel with included hardware. Use in 6"W (152 mm) or wider vertical cable managers; one kit per side. Bars are .23" (5.7 mm) in diameter; two bars are 23.7"L (602 mm), four bars are 16.6"L (422 mm), and they are made from steel, zinc-plated and silver-colored. Each kit includes six lashing bars and mounting hardware.

13935-701

13928-001

| Part Number | Description Width - in (mm) | Shipping Weight lb (kg) |
|------------------------------|--|----------------------------|
| Cable Ring Kit | | |
| 13934-716 | Cable Ring Kit for 6 (1.8) x 3.6 (91) Manager, Black | 8 (3.6) |
| 13934-717 | Cable Ring Kit for 7 (2.1) x 3.6 (91) Manager, Black | 9 (4.1) |
| 13934-718 | Cable Ring Kit for 8 (2.4) x 3.6 (91) Manager, Black | 11 (5.0) |
| 13934-726 | Cable Ring Kit for 6 (1.8) x 6 (152) Manager, Black | 9 (4.1) |
| 13934-727 | Cable Ring Kit for 7 (2.1) x 6 (152) Manager, Black | 11 (5.0) |
| 13934-728 | Cable Ring Kit for 8 (2.4) x 6 (152) Manager, Black | 12 (5.4) |
| 13934-746 | Cable Ring Kit for 6 (1.8) x 10 (254) Manager, Black | 12 (5.4) |
| 13934-747 | Cable Ring Kit for 7 (2.1) x 10 (254) Manager, Black | 14 (6.4) |
| 13934-748 | Cable Ring Kit for 8 (2.4) x 10 (254) Manager, Black | 15 (6.8) |
| 13934-756 | Cable Ring Kit for 6 (1.8) x 12 (305) Manager, Black | 14 (6.4) |
| 13934-757 | Cable Ring Kit for 7 (2.1) x 12 (305) Manager, Black | 16 (7.3) |
| 13934-758 | Cable Ring Kit for 8 (2.4) x 12 (305) Manager, Black | 18 (8.2) |
| Cable Spool Kit | | |
| 13935-701 | Cable Spool Kit, Pack of 4, Black | 2 (0.9) |
| Cable Lashing Bar Kit | | |
| 13928-001 | Cable Lashing Bar Kit, Zinc | 2 (0.9) |



Velocity Horizontal Cable Manager

Features T-shaped cable guides at the top and bottom of the manager, two cable openings in the rear of the manager allow front-to-rear cabling, and the snap-on cover stays in the opened position to provide easy access to cables.

Horizontal Cable Manager includes:

- (1) 19" W EIA rack-mount cable manager with T-shaped cable guides; (1) cover that snaps-on to the T-shaped cable guides; (4) #12-24 x 1" rack-mount screws and (4) M6 x 25 mm rack-mount screws

| Part Number | Description H x W x D in (mm) | Shipping Weight lb (kg) |
|-------------|-------------------------------------|-------------------------------|
| 13930-701 | 1U x 19 x 5.9 (150), Black | 2 (0.9) |
| 13930-702 | 2U x 19 x 5.9 (150), Black | 3 (1.4) |
| 13930-703 | 3U x 19 x 5.9 (150), Black | 3 (1.4) |



Rack-Mount Unit (U) marks simplify equipment installation



Ground Studs located directly on rack channel



Side cable openings align with U marks on the rack

Velocity Standard Pack

The Velocity Standard Pack is an easy-to-use solution for managing equipment and cabling at the cross connect. The Velocity Standard Pack is offered in four variations, with a single-sided or double-sided cable manager in either 3.6" W (91 mm) or 6" W (152 mm). Cable managers can be mounted on either side of the standard rack.

- Numbered rack-mount spaces on the Standard Rack are printed on the equipment mounting channels, providing the installer an easy way of positioning equipment in planned spaces
- Cable openings in Velocity Vertical Cable Managers align with rack-mount units on the rack, allowing cables to exit by rack-mount units
- Integrated masked bonding studs on the inside of the rack channel for quick attachment to the Telecommunications Bonding System
- Cable openings have rounded edges to protect cable and will not deform or break
- Cover snaps on and opens to the right or left for easy access to cables during moves, adds or changes

Velocity Standard Pack includes:

- (1) 45U x 19" Standard Rack
- (1) Single or double-sided Velocity vertical cable manager
- (1) Rack installation kit for concrete floors

| Part Number | Description Width in (mm) | Shipping Weight lb (kg) |
|-------------|---|-------------------------------|
| 57011-703 | (1) Standard Rack, 45U x 19" EIA, UL, Black; (1) Velocity Single-Sided Vertical Cable Manager, 3.6" W (91 mm), Black; (1) Rack Installation Kit for concrete floor, 1/2" hardware, Zinc | 47 (21.3) |
| 57012-703 | (1) Standard Rack, 45U x 19" EIA, UL, Black; (1) Velocity Double-Sided Vertical Cable Manager, 3.6" W (91 mm), Black; (1) Rack Installation Kit for concrete floor, 1/2" hardware, Zinc | 60 (27.2) |
| 57013-703 | (1) Standard Rack, 45U x 19" EIA, UL, Black; (1) Velocity Single-Sided Vertical Cable Manager, 6" W (152 mm), Black; (1) Rack Installation Kit for concrete floor, 1/2" hardware, Zinc | 50 (22.7) |
| 57014-703 | (1) Standard Rack, 45U x 19" EIA, UL, Black; (1) Velocity Double-Sided Vertical Cable Manager, 6" W (152mm), Black; (1) Rack Installation Kit for concrete floor, 1/2" hardware, Zinc | 68 (30.8) |



Double-Sided MCS shown with door open

Shown on rack with Jumper Tray

MCS Master Cabling Section

The MCS Master Cabling Section virtually eliminates the need for horizontal cable managers by providing frequent 1U spacing of the cable guides that aligns precisely with the rack spacing.

Includes innovative, rigid aluminum SwitchGate Door/Cover that hides and conceals cable. A handle is included on the outside of the door/cover, making removal and installation even easier.

- Extra-wide, contoured cable guides provide smooth movement and meet UL 94V-0 Flame Resistant standards
- SwitchGate Door/Cover is easily switched from right to left opening and can be removed
- Double-Sided MCS Master Cabling Sections have edge-protected pass-through ports and vertical slots for optional cable ties
- 10"W (250 mm) version includes (4) Cable Distribution Spools
- Mounting hardware and doors are included
- Attaches to Standard Racks, Universal Racks or QuadraRacks

MCS-EFX Master Cabling Section with Extended Fingers

The MCS-EFX is a larger, higher capacity version of the MCS Master Cabling Section and is designed for use with most two- and four-post racks to manage cable at the cross connect, especially when using angled-face copper patch panels. MCS-EFX is packaged in a single carton for easy handling and includes installation hardware.

- Cable openings on the side of MCS-EFX are sized to accommodate 48 patch cords, twice the capacity of the standard MCS; openings have rounded edges to protect cable and will not deform or break
- Patented cable openings on the sides of MCS-EFX align with rack-mount unit space on the rack, allowing cables to exit by rack-mount unit
- The door hinges open to the right or left for easy access to cables during moves, adds and changes and locks in the closed position to protect cables from damage
- Plastic Cable Guides meet UL 94V-0 Flame Resistant standards
- 10"W and 12"W (250 mm and 300 mm) Double-Sided MCS-EFX include (4) Cable Distribution Spools
- Mounting hardware and doors are included
- Attach to Standard Racks, Universal Racks, QuadraRacks or Adjustable QuadraRack frames

PATENTED

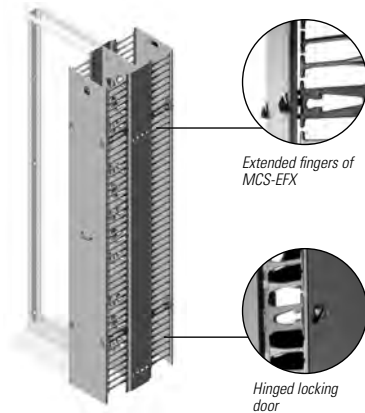

Extended fingers of MCS-EFX

Hinged locking door

Use the part number matrix below to select your MCS Master Cabling Section. **Example Part Number: 30091-703.**

| Finger Length | | Width/Style | | - | Color | Height | |
|---------------|----------------|-------------|---------------------|---|-------|---------------|---------|
| 30 | Standard | 091 | 4.4"W, Single-Sided | | 5 | Clear | 00 5.5' |
| 40 | Extended (EFX) | 092 | 6"W, Single-Sided | | 7 | Black | 01 6.0' |
| | | 093 | 10"W, Single-Sided | | E | Glacier White | 02 6.5' |
| | | 094 | 4.4"W, Double-Sided | | | | 03 7.0' |
| | | 095 | 6"W, Double-Sided | | | | 05 7.5' |
| | | 096 | 10"W, Double-Sided | | | | 15 8.0' |
| | | 097 | 12"W, Double-Sided* | | | | 08 9.0' |

X=Color; 5=Clear, 7=Black, E=Glacier White. Clear (-5XX) versions have black doors/covers and cable guides.

Extended Finger Cabling Sections (EFX) are only available in 7"H, 7.5"H and 8"H. 12"W is only available in Extended Finger styles (40097).

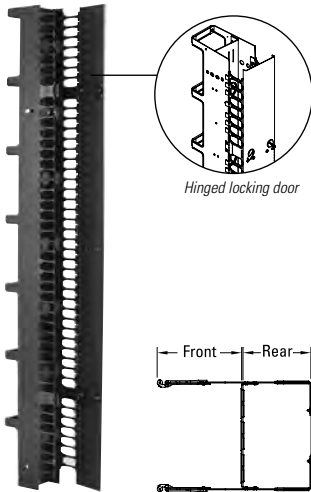

CCS Combination Cabling Section

The CCS Combination Cabling Section offers the best of CPI's cabling sections, but with added design features. This cabling section is double-sided with the front side, featuring plastic cable guides (like those used on the MCS Master Cabling Section), while the back retains the classic VCS Vertical Cabling Section design.

- 1U cable guides on the front designed for fanning and managing patch cords
- Open cabling section on the rear provides easy access and routes cable bundles feeding into the back of patch panels
- Edge-protected pass-through ports make it easy to route cable from front-to-back; vertical slots along the center separator neatly secure cable bundles
- Plastic Cable Guides meet UL 94V-0 Flame Resistant standards
- Innovative SwitchGate Door/Cover (front) is easily opened from the right or left and can be removed so that cable does not have to thread through guides
- Attach to Standard Racks, Universal Racks, QuadraRack or Adjustable QuadraRack frames
- Mounting hardware and doors are included

Usable Depth

For 3" D (80 mm) Rack Version:

Front=5.90" (149.9 mm); Rear=5.35" (135.9 mm)

For 6" D (150 mm) Rack Version:

Front=7.40" (188.0 mm); Rear=6.85" (174.0 mm)

| Part Number 3" D (80 mm) Racks | Height ft (m) | Depth in (mm) | Shipping Weight lb (kg) |
|---|------------------|------------------|-------------------------------|
| 3.65" W (92.7 mm) | | | |
| 30161-X01 | 6 (1.8) | 12.24 (311) | 25 (11.3) |
| 30161-X03 | 7 (2.1) | 12.24 (311) | 29 (13.2) |
| 30161-X05 | 7.6 (2.3) | 12.24 (311) | 31 (14.1) |
| 30161-X15 | 8 (2.4) | 12.24 (311) | 33 (15.0) |
| 30161-X08 | 9 (2.7) | 12.24 (311) | 38 (17.2) |
| 6" W (150 mm) | | | |
| 30162-X01 | 6 (1.8) | 12.24 (311) | 29 (13.2) |
| 30162-X03 | 7 (2.1) | 12.24 (311) | 34 (15.4) |
| 30162-X05 | 7.6 (2.3) | 12.24 (311) | 37 (16.8) |
| 30162-X15 | 8 (2.4) | 12.24 (311) | 39 (17.7) |
| 30162-X08 | 9 (2.7) | 12.24 (311) | 44 (20.0) |
| 10" W (250 mm) | | | |
| 30163-X01 | 6 (1.8) | 12.24 (311) | 40 (18.1) |
| 30163-X03 | 7 (2.1) | 12.24 (311) | 46 (20.9) |
| 30163-X05 | 7.6 (2.3) | 12.24 (311) | 50 (22.7) |
| 30163-X15 | 8 (2.4) | 12.24 (311) | 53 (24.0) |
| 30163-X08 | 9 (2.7) | 12.24 (311) | 59 (26.8) |

| Part Number 6" D (150 mm) Racks | Height ft (m) | Depth in (mm) | Shipping Weight lb (kg) |
|--|------------------|------------------|-------------------------------|
| 3.65" W (92.7 mm) | | | |
| 30164-X01 | 6 (1.8) | 14.61 (371) | 28 (12.7) |
| 30164-X03 | 7 (2.1) | 14.61 (371) | 33 (15.0) |
| 30164-X05 | 7.6 (2.3) | 14.61 (371) | 36 (16.3) |
| 30164-X15 | 8 (2.4) | 14.61 (371) | 38 (17.2) |
| 30164-X08 | 9 (2.7) | 14.61 (371) | 43 (19.5) |
| 6" W (150 mm) | | | |
| 30165-X01 | 6 (1.8) | 14.61 (371) | 33 (15.0) |
| 30165-X03 | 7 (2.1) | 14.61 (371) | 38 (17.2) |
| 30165-X05 | 7.6 (2.3) | 14.61 (371) | 41 (18.6) |
| 30165-X15 | 8 (2.4) | 14.61 (371) | 44 (20.0) |
| 30165-X08 | 9 (2.7) | 14.61 (371) | 49 (22.2) |
| 10" W (250 mm) | | | |
| 30166-X01 | 6 (1.8) | 14.61 (371) | 42 (19.1) |
| 30166-X03 | 7 (2.1) | 14.61 (371) | 49 (22.2) |
| 30166-X05 | 7.6 (2.3) | 14.61 (371) | 53 (24.0) |
| 30166-X15 | 8 (2.4) | 14.61 (371) | 56 (25.4) |
| 30166-X08 | 9 (2.7) | 14.61 (371) | 63 (28.6) |

CCS-EFX Combination Cabling Section With Extended Fingers

The CCS-EFX is a double-sided vertical cable management trough designed for use with most two- and four-post racks to manage cable at the cross connect, especially when using angled-face copper patch panels.

The CCS-EFX is manufactured from a combination of strong, lightweight aluminum sheet and plenum-rated composite materials for maximum strength at minimal weight. CCS-EFX is packaged in a single carton for easy handling and includes installation hardware.

- Cable openings on the front are sized to fit 48 patch cords, twice the capacity of the CCS; openings have rounded edges to protect cable and will not deform or break
- Cable openings on front of CCS-EFX align with rack-mount unit on rack, allowing cables to exit by rack-mount unit
- The front door hinges open to the right or left and locks in the closed position to protect cables
- Open cabling section on the rear of CCS-EFX allows large premise cable bundles to exit the manager into the rack-mount space. Spin closure latches secure cables
- Attach to 3"D (80 mm) Standard Racks, Universal Racks or QuadraRack frames
- Mounting hardware and doors are included



Extended fingers of CCS-EFX



Hinged locking door

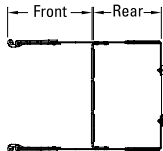

Usable Depth
Front=8.60" (218.4 mm)
Rear=5.35" (135.9 mm)

| Part Number | Height ft (m) | Description H x W x D in (mm) | Shipping Weight lb (kg) |
|----------------------|---------------|-------------------------------|-------------------------|
| 6"W (150 mm) | | | |
| 40098-X03 | 7 (2.1) | 14.94 (379.5) | 38 (17.2) |
| 40098-X05 | 7.6 (2.3) | 14.94 (379.5) | 41 (18.6) |
| 40098-X15 | 8 (2.4) | 14.94 (379.5) | 44 (20.0) |
| 10"W (250 mm) | | | |
| 40099-X03 | 7 (2.1) | 14.94 (379.5) | 52 (23.6) |
| 40099-X05 | 7.6 (2.3) | 14.94 (379.5) | 56 (25.4) |
| 40099-X15 | 8 (2.4) | 14.94 (379.5) | 60 (27.2) |
| 12"W (300 mm) | | | |
| 40100-X03 | 7 (2.1) | 14.94 (379.5) | 56 (25.4) |
| 40100-X05 | 7.6 (2.3) | 14.94 (379.5) | 60 (27.2) |
| 40100-X15 | 8 (2.4) | 14.94 (379.5) | 64 (29.0) |

X=Color, 7=Black, E=Glacier White.

Global Vertical Cabling Section

An adaptable vertical cable management solution with a unique, two-piece design that reduces shipping size and cost. The two parts can be quickly assembled and then bolted to CPI's Universal and Standard racks, as well as QuadraRack and Adjustable QuadraRack frames. It ships partially assembled with patented cable guide fingers at 1U intervals. Each single-sided section includes a two-piece section, a two-piece door/cover and mounting hardware. Each double-sided section is a one-piece section and two-piece door/cover.

- Patented cable guide fingers at 1U intervals provide an organized pathway for cable and patch cords; 7'H (2.1 m) provides 45U
- Snap-on, hinged door/cover hides cable for a finished appearance, yet allows quick access to cable for making changes
- Door/cover swings on hinges to open left or right
- Acorn nuts eliminate sharp edges, reducing injuries and torn cables
- Seven 2.5" (64 mm) pass-through ports allow cables to transition front to back

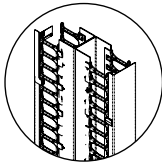

Double-Sided

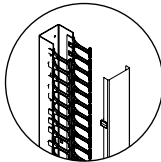

Single-Sided

| Part Number | Description Width in (mm) | Shipping Weight lb (kg) |
|-------------|--|----------------------------|
| 12830-X03 | Single-Sided, 7'H x 3.65"W x 6.76"D, Narrow (2.1 m x 92.7 mm x 171.7 mm) | 16 (7.3) |
| 12832-X03 | Single-Sided, 7'H x 3.65"W x 9.30"D, Narrow (2.1 m x 92.7 mm x 236.2 mm) | 18 (8.2) |
| 12831-X03 | Single-Sided, 7'H x 6"W x 6.76"D, Wide (2.1 m x 150 mm x 171.7 mm) | 19 (8.6) |
| 12833-X03 | Single-Sided, 7'H x 6"W x 9.30"D, Wide (2.1 m x 150 mm x 236.2 mm) | 22 (10.0) |
| 12834-X03 | Single-Sided, 7'H x 10"W x 6.76"D, Wide (2.1 m x 250 mm x 171.7 mm) | 26 (11.8) |
| 12835-X03 | Single-Sided, 7'H x 10"W x 9.30"D, Wide (2.1 m x 250 mm x 236.2 mm) | 28 (12.7) |
| 14830-X03 | Double-Sided, 7'H x 3.65"W x 13.52"D, Narrow (2.1 m x 92.7 mm x 343.4 mm) | 32 (14.5) |
| 14831-X03 | Double-Sided, 7'H x 6"W x 13.52"D, Wide (2.1 m x 150 mm x 343.4 mm) | 39 (17.7) |
| 14832-X03 | Double-Sided, 7'H x 10"W x 13.52"D, Wide (2.1 m x 250 mm x 343.4 mm) | 47 (21.3) |

X-color: 5=Clear, 7=Black, E=Glacier White. Clear (-5XX) versions are only available in Double-Sided versions, and have black doors/covers and cable guides.



Rings shown attached to GVCS

Cable Rings For GVCS

| Part Number & Finish | | Description | Shipping Weight lb (kg) |
|----------------------|---------------|------------------------|----------------------------|
| Black | Glacier White | | |
| 12836-701 | 12836-E01 | 3.65"W (92.7 mm) Rings | 4 (1.8) |
| 12836-702 | 12836-E02 | 6"W (150 mm) Rings | 5 (2.3) |
| 12836-703 | 12836-E03 | 10"W (250 mm) Rings | 7 (3.2) |

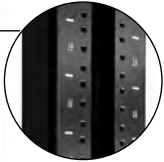
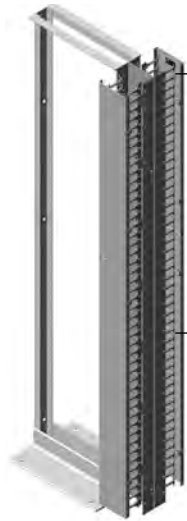

Standard Rack with U printed on rack

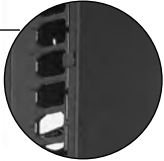

Fingers align with U on rack



Integrated masked ground studs

Global Standard Pack

The Global Standard Pack shown has two Global Vertical Cabling Sections used back-to-back on the same side of the rack to create a double-sided cable manager. Cabling sections can also be mounted on opposite sides of the rack to create two single-sided cable pathways.

- Numbered rack-mount unit (U) spaces on the rack are printed on the equipment mounting channels, providing the installer an easy way of positioning equipment in planned spaces
- Cable openings in Global Vertical Cabling Section align with U spaces on the rack, allowing cables to exit by the U
- Integrated masked bonding studs on the inside of the rack channel for quick attachment to the Telecommunications Bonding System
- Cable openings have rounded edges to protect cable and will not deform or break
- Door/cover snaps on and opens to the right or left for easy access to cables during moves, adds or changes
- Global Standard Pack is UL Listed as a communication circuit accessory
- Rack installation kit for concrete floor

| Part Number | Description Width in (mm) | Shipping Weight lb (kg) |
|-------------|--|-------------------------|
| 57001-X03 | (1) Standard Rack, 45U x 19" EIA, UL (1) GVCS Single-Sided Vertical Cable Manager, 3.65"W (92.7 mm) (1) Rack Installation Kit for concrete floor, 1/2" hardware, Zinc | 50 (22.7) |
| 57002-X03 | (1) Standard Rack, 45U x 19" EIA, UL (2) GVCS Single-Sided Vertical Cable Managers, 3.65"W (92.7 mm) (1) Rack Installation Kit for concrete floor, 1/2" hardware, Zinc | 65 (29.5) |
| 57003-X03 | (1) Standard Rack, 45U x 19" EIA, UL (1) GVCS Single-Sided Vertical Cable Manager, 6"W (150 mm) (1) Rack Installation Kit for concrete floor, 1/2" hardware, Zinc | 52 (23.6) |
| 57004-X03 | (1) Standard Rack, 45U x 19" EIA, UL (2) GVCS Single-Sided Vertical Cable Managers, 6"W (150 mm) (1) Rack Installation Kit for concrete floor, 1/2" hardware, Zinc | 67 (30.4) |

X=Color: 5=Clear, 7=Black, E=Glacier White. Clear (-5XX) versions include GVCS with black doors/covers and cable guides. GVCS is 6.76"D (171.7 mm).



Combines a 7'H x 19"W x 3"D (2.1m x 19"W x 80 mm) Standard Rack, Global Vertical Cabling Sections and Concrete Floor Installation Kit into one convenient shipping container!

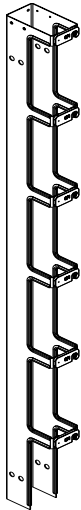

11730-X03
Single-Sided Narrow

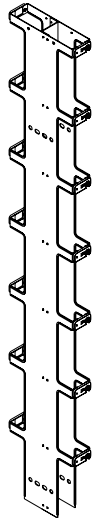

12096-X03
Double-Sided Narrow

Narrow Vertical Cabling Section

- Bolts to CPI Standard Rack, Universal Rack, QuadraRack 4-Post Frame and QuadraRack Server Frame
- Includes formed cabling section, lockable cabling latches - 12" (300 mm) between latches, protective edge guards and mounting hardware

Single-Sided:

- 9' (2.7 m) version consists of a 7' (2.1 m) section and 2' (0.6 m) extension

Double-Sided:

- 1.38" x 2.25" (35.1 mm x 57.2 mm) oval pass-through ports every 11.62" (295.1 mm)
- 9' (2.7 m) version consists of 7' (2.1 m) section with a 2' (0.6 m) extension
- Mounting hardware included

| Part Number | Description Width in (mm) |
|-------------|---|
| 11730-X00 | 5.6 (1.7 m) H x 3.65"W x 6.38"D (92.7 mm x 162.1 mm), SS |
| 11730-X01 | 6' (1.8 m) H x 3.65"W x 6.38"D (92.7 mm x 162.1 mm), SS |
| 11730-X02 | 6.6 (2.0 m) H x 3.65"W x 6.38"D (92.7 mm x 162.1 mm), SS |
| 11730-X03 | 7' (2.1 m) H x 3.65"W x 6.38"D (92.7 mm x 162.1 mm), SS |
| 11730-X05 | 7.6' (2.3 m) H x 3.65"W x 6.38"D (92.7 mm x 162.1 mm), SS |
| 11730-X15 | 8' (2.4 m) H x 3.65"W x 6.38"D (92.7 mm x 162.1 mm), SS |
| 11730-X08 | 9' (2.7 m) H x 3.65"W x 6.38"D (92.7 mm x 162.1 mm), SS |
| 12096-X03 | 7' (2.1 m) H x 3.65"W x 12.75"D (92.7 mm x 323.9 mm), DS |
| 12096-X15 | 8' (2.4 m) H x 3.65"W x 12.75"D (92.7 mm x 323.9 mm), DS |
| 12096-X08 | 9' (2.7 m) H x 3.65"W x 12.75"D (92.7 mm x 323.9 mm), DS |

X=color: 1=Gray, 2=Computer Beige, 5=Clear, 7=Black, E=Glacier White.



11734-X03
Single-Sided Wide



12096-X03
Double-Sided Narrow

Wide Vertical Cabling Section

- Bolts to CPI Standard Rack, Universal Rack, QuadraRack 4-Post Frame and QuadraRack Server Frame

Single-Sided:

- 6"W x 6.38"D (150 mm x 162.1 mm); single-sided cable trough
- 9' (2.7 m) version consists of 7' (2.1 m) section with a 2' (0.6 m) extension

Double-Sided:

- 2.5" (64.0 mm) diameter pass-through ports every 11.62" (295.1 mm)
- 9' (2.7 m) version consists of a 7' (2.1 m) section with a 2' (0.6 m) extension
- Mounting hardware included

| Part Number | Description Width in (mm) |
|-------------|--|
| 11374-X00 | 5.6 (1.7 m) H x 6"W x 6.38"D (150 mm x 162.1 mm) |
| 11374-X01 | 6' (1.8 m) H x 6"W x 6.38"D (150 mm x 162.1 mm) |
| 11374-X02 | 6.6 (2.0 m) H x 6"W x 6.38"D (150 mm x 162.1 mm) |
| 11374-X03 | 7' (2.1 m) H x 6"W x 6.38"D (150 mm x 162.1 mm) |
| 11374-X05 | 7.6' (2.3 m) H x 6"W x 6.38"D (150 mm x 162.1 mm) |
| 11374-X15 | 8' (2.4 m) H x 6"W x 6.38"D (150 mm x 162.1 mm) |
| 11374-X08 | 9' (2.7 m) H x 6"W x 6.38"D (150 mm x 162.1 mm) |
| 11729-X03 | 7' (2.1 m) H x 6"W x 12.75"D (150 mm x 323.9 mm), DS |
| 11729-X15 | 8' (2.4 m) H x 6"W x 12.75"D (150 mm x 323.9 mm), DS |
| 11729-X08 | 9' (2.7 m) H x 6"W x 12.75"D (150 mm x 323.9 mm), DS |

X=color: 1=Gray, 2=Computer Beige, 5=Clear, 7=Black, E=Glacier White.

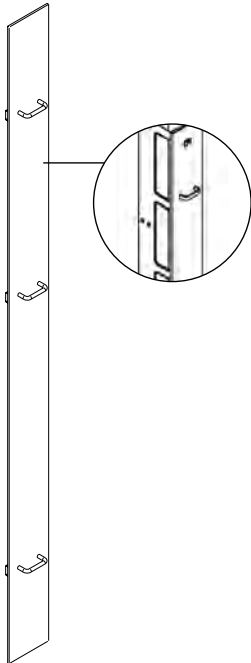

Cabling Section Cover

Designed to be used on narrow and wide Vertical Cabling Sections to provide a clean, professional appearance. Available in metal or plexiglass versions; plexiglass for 7' (2.1 m) only; in sizes to fit your installation.

- Hides cables
- Provides professional appearance
- Quick attachment and removal
- For use with vertical cabling sections only

| Part Number | Height ft (m) | Description/Style | Shipping Weight lb (kg) |
|-------------------------|---------------|-------------------|-------------------------|
| 3.65"W (92.7 mm) | | | |
| 12664-X02 | 7 (2.1) | Metal | 8 (3.6) |
| 11923-X05 | 7.6 (2.3) | Metal | 4 (1.8) |
| 11923-X15 | 8 (2.4) | Metal | 5 (2.3) |
| 11923-X08 | 9 (2.7) | Metal | 5 (2.3) |
| 6"W (150 mm) | | | |
| 12664-X01 | 7 (2.1) | Metal | 9 (4.1) |
| 11922-X05 | 7.6 (2.3) | Metal | 7 (3.2) |
| 11922-X15 | 8 (2.4) | Metal | 7 (3.2) |
| 11922-X08 | 9 (2.7) | Metal | 8 (3.6) |

X=color: 7=Black, E=Glacier White

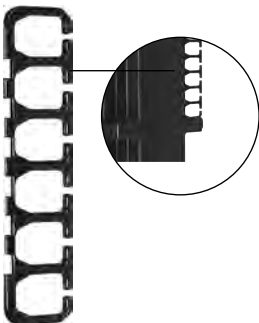

Finger Snaps Cable Guides

Adding Finger Snaps Cable Guides is a snap. The unique design provides retrofit cable guides in-between the latches on VCS Vertical Cabling Sections or CCS Combination Cabling Sections.

- Plastic cable guides that easily retrofit onto CPI VCS Vertical Cabling Sections or CCS Combination Cabling Sections
- Resilient composite material ensures long lasting, quality construction
- Extra-wide and contoured guides allow smooth transition of the cable from the horizontal pathway into a CPI cabling section
- 1U cable guides are designed for fanning and managing patch cords or cables
- Meets UL 94V-0 Flame Resistant standards

| Part Number | Description | Shipping Weight lb (kg) |
|-------------|------------------------|-------------------------|
| 12370-001 | 2 Finger Snaps, Black | 1 (0.5) |
| 12370-002 | 12 Finger Snaps, Black | 2 (0.9) |

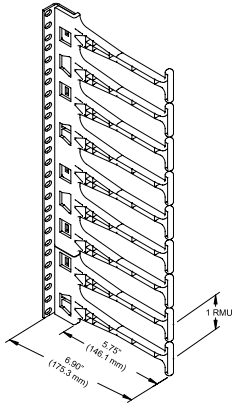

Extended Fingers Bracket

Extended Fingers Bracket provides extra-deep cable management capacity and improves cable bend radius management, meeting or exceeding the needs of the latest Category 5e/6/6a or fiber industry standards. It is a cost-effective accessory for cable management in specific areas of the rack, rather than along its entire height.

- Preassembled in 7U, 9U and 13U heights for mounting directly onto any industry-standard rack
- Patented cable guide fingers at 1U intervals provide an organized cable pathway
- Made of durable, flame-retardant (UL 94V-0) plastic for environmental safety
- Also compatible with accessory cable management finger kits for SeismicFrame Two-Post Rack, Adjustable Rail QuadraRack and Adjustable Rail ServerRack see P/N 13696-00X and 15286-0XX, respectively)

| Part Number | Description | Shipping Weight lb (kg) |
|-------------|-------------|-------------------------|
| 12891-X03 | 7U, Each | 2 (0.9) |
| 12891-X01 | 9U, Each | 4 (1.8) |
| 12891-X02 | 13U, Each | 4 (1.8) |

X=color: 7=Black, E=Glacier White.



Tool-less Bend Radius Kit for Fiber Patch Cords

Tool-less Bend Radius Kit for Fiber Patch Cords ensures proper bend radius support for fiber optic patch cords when transitioning through T-shaped cable guides. It snaps onto the finger manager without any tools, and can be used for new or retrofit applications. Color is Black.

- Compatible with N-Series TeraFrame® Gen 3 Network Cabinet System, Evolution and Motive Cable Management
- Also compatible with accessory cable management finger kits for SeismicFrame Two-Post Rack, Adjustable Rail QuadraRack and Adjustable Rail ServerRack (see P/N 13696-00X and 15286-0XX, respectively)

| Part Number | Description | Shipping Weight lb (kg) |
|-------------|---------------------------------------|-------------------------|
| 32697-001 | Tool-less Bend Radius Kit, Pack of 10 | 1 (0.5) |
| 32697-002 | Tool-less Bend Radius Kit, Pack of 50 | 3 (1.4) |



Spools mounted on a double-sided vertical cabling section

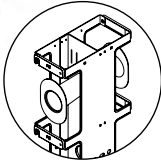

Cable Distribution Spools

ECable Distribution Spools provide slack management and strain relief for patch cords and jumper cables inside CPI Vertical Cable Managers. Designed for use inside any CPI double-sided vertical cable manager 10"W and wider, including VCS, MCS, MCS-EFX, CCS, CCS-EFX and Evolution® g2 Double-Sided Vertical Cable Manager. Also compatible with Evolution® g1 Single-Sided Vertical Cable Manager.

- Three large cable distribution spools are included with each 10", 12" and 15"W (250 mm, 300 mm and 380 mm) vertical cable manager (will not fit other sizes)
- Attaches to the fixed adapter panels on the back of single-sided vertical cable managers and the Movable Mid-Sections inside the double-sided vertical cable managers
- Spools are 2.75" (69.9 mm) in diameter, 5.9" L (150 mm) and made from black plastic
- Each kit includes four spools and mounting hardware
- Made of high-impact, flame retardant material

| Part Number | Description | Shipping Weight lb (kg) |
|-------------|------------------|-------------------------|
| 15008-001 | Spool Kit, Black | 2 (0.9) |

2" (50 mm) Diameter Fiber Management Spools

Use the 2" (50 mm) Diameter Fiber Management Spool to support fiber and copper cables within CPI's extensive line of vertical cabling sections. The spools meet EIA/TIA bend radius requirements, and minimize cable tangles and tears for more efficient data transmission.

- Provides proper cable support and bend radius for more efficient data transmission
- Maintains strength under heavy cable loads
- Mounts to all CPI vertical cabling sections 6"W (150 mm) or wider, including MCS, MCS-EFX, CCS, CCS-EFX and VCS

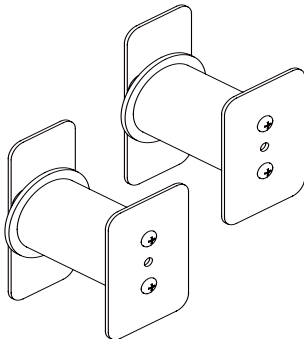

| Part Number | Application Width in (mm) | Package Of | Shipping Weight lb (kg) |
|-------------------------|---|------------|-------------------------|
| 3.65"W (92.7 mm) | | | |
| 12766-X02 | For 6, 10 or 12 (150, 250 or 300) Double-Sided Cabling Sections | 2 | 2 (0.9) |
| 12766-X07 | For 6, 10 or 12 (150, 250 or 300) Double-Sided Cabling Sections | 7 | 5 (2.3) |

X=color: 7=Black, E=Glacier White



Universal Horizontal Cable Manager

Create a highly functional horizontal pathway for patch cords and multimedia applications using coax, copper and fiber optic cables. After routing the cables or cords, simply snap-on the cover for a clean, professional appearance.

- Extra-wide and contoured cable guide fingers, spaced 1.75" (44.5 mm) apart, separate and organize patch cords for quick and easy moves, adds and changes.
- The cable guides are offset to ensure proper bending radii of patch cables, even hooded patch cables
- Patented fingers meet the requirements of UL 94V-0 flammability rating
- Snap-on covers are easy to use and open 180° up or down with adjacent installation
- Covers and panel have a black powder-coat textured finish, reducing fingerprints and smudges

Double-Sided Universal Horizontal Cable Manager

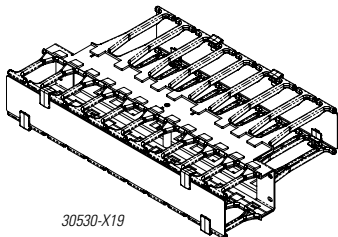

30530-X19

| Part Number | Description H x W x D in (mm) | Shipping Weight lb (kg) |
|-------------|-------------------------------------|----------------------------|
| 30529-X19 | 1U x 19 x 11.73 (297.9) | 5 (2.3) |
| 30529-X23 | 1U x 23 x 11.73 (297.9) | 6 (2.7) |
| 30530-X19 | 2U x 19 x 11.73 (297.9) | 6 (2.7) |
| 30530-X23 | 2U x 23 x 11.73 (297.9) | 7 (3.2) |
| 30531-X19 | 3U x 19 x 11.73 (297.9) | 6 (2.7) |
| 30531-X23 | 3U x 23 x 11.73 (297.9) | 7 (3.2) |

X=color: 7=Black, E=Glacier White.

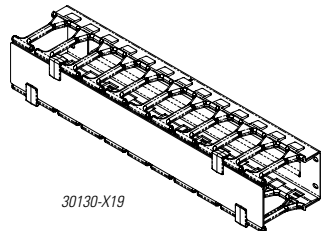

30130-X19

Single-Sided Universal Horizontal Cable Manager

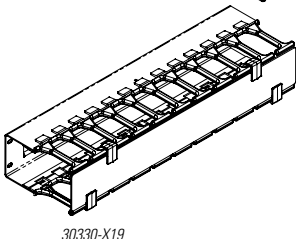

30330-X19

| Part Number | Description H x W x D in (mm) | Shipping Weight lb (kg) |
|-------------|-------------------------------------|----------------------------|
| 30139-X19 | 1U x 19 x 4.96 (126.0) | 2 (0.9) |
| 30139-X23 | 1U x 23 x 4.96 (126.0) | 3 (1.4) |
| 30130-X19 | 2U x 19 x 5.14 (130.6) | 3 (1.4) |
| 30130-X23 | 2U x 23 x 5.14 (130.6) | 4 (1.8) |
| 30131-X19 | 3U x 19 x 5.14 (130.6) | 4 (1.8) |
| 30131-X23 | 3U x 23 x 5.14 (130.6) | 5 (2.3) |
| 30339-X19* | 1U x 19 x 6.26 (159.0) | 3 (1.4) |
| 30339-X23* | 1U x 23 x 6.26 (159.0) | 3 (1.4) |
| 30330-X19* | 2U x 19 x 6.44 (163.6) | 4 (1.8) |
| 30330-X23* | 2U x 23 x 6.44 (163.6) | 5 (2.3) |
| 30331-X19* | 3U x 19 x 6.44 (163.6) | 5 (2.3) |
| 30331-X23* | 3U x 23 x 6.44 (163.6) | 6 (2.7) |

X=color: 7=Black, E=Glacier White. *Note: Deep Panel is used when Double-Sided MCS Master Cabling Sections are center-mounted on 3" D racks.

Use Universal Horizontal Cable Manager in conjunction with the CPI Patch Panel Wire Management Bar (P/N 12176-X01) and any of CPI's vertical cabling sections for clean, organized cable management.

Horizontal Cable Management Accessories

Patch Panel Wire Management Bar

19" rack-mountable bar provides the necessary wire management and strain relief recommended by ANSI/TIA/EIA. May be mounted inward for 6" (150 mm) channel or outward to standard 3" (80 mm) rack side channel; attaches to rack with standard #12-24 rack screws (not included). Wire tie holes maintain wire perpendicular relative to termination point; made of sturdy aluminum and sold individually.

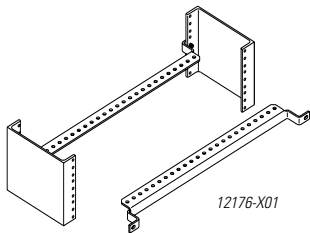

Horizontal Wire Management Panel for VCS

19" Wire Management Panel is offset 1.5" (38 mm) from the rack channel to ensure proper bending radii of patch cables, even hooded patch cables. Use in combination with VCS Vertical Cabling Sections. Unique offset design provides patch cable pathway from front-to-back or side-to-side. Available in single 1.75" (44.5 mm) or double 3.5" (89.0 mm) rack-mount unit designs. Mounts quickly and easily using threaded cable distribution spools; cable distribution spools maintain bend radius through the pass-through trough and across the front plane of the horizontal manager.

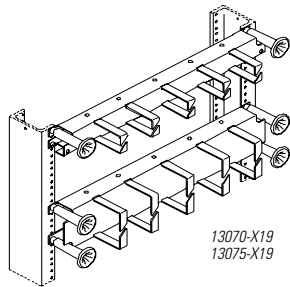

Horizontal Wire Management Panel for MCS and CCS

Use in combination with MCS Master Cabling Section and CCS Combination Cabling Section to provide open horizontal management for cables.

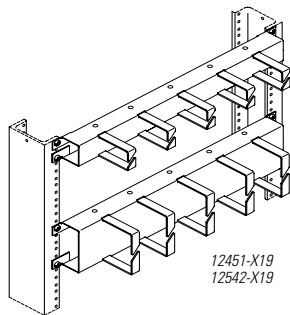

| Part Number | Description Width - in (mm) | Shipping Weight lb (kg) |
|-------------|---------------------------------------|----------------------------|
| 12176-X01 | Patch Panel Wire Management Bar | 1 (0.5) |
| 13070-X19 | Horizontal Wire Panel for VCS, 1U | 2 (0.9) |
| 13075-X19 | Horizontal Wire Panel for VCS, 2U | 2 (0.9) |
| 12541-X19 | Horizontal Wire Panel for MCS/CCS, 1U | 2 (0.9) |
| 12542-X19 | Horizontal Wire Panel for MCS/CCS, 2U | 2 (0.9) |

X=color: 1=Gray, 2=Computer Beige, 5=Clear, 7=Black, E=Glacier White.

2U

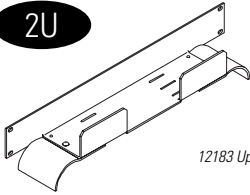

12183 Upper Tray

2U

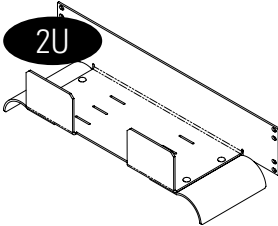

12183 Deep Upper Tray

2U

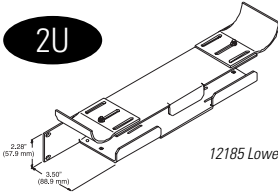

12185 Lower Tray, Single

3U

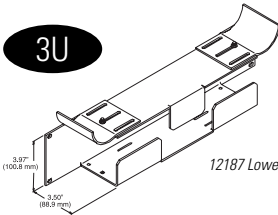

12187 Lower Tray, Double

18.50"

(468.7 mm)

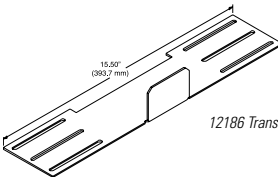

12186 Transition Plate

Jumper And Transition Trays

The Jumper and Transition Trays aid in compliance with ANSI/TIA/EIA-568B bend radius requirements. Two styles are available to provide upper and lower horizontal/vertical cable management and promote a gradual, controlled bend for both UTP and optical fiber cable. Adjust the position of the bend radius to deliver cables into the vertical cable manager or attach a transition plate between trays to create a solid wire way between racks. Mounting screws not included. Sold individually.

- Provides 1-1/2" (38 mm) bend radius for compliant installation of Category 5e/6/6a or fiber cable
- Telescopes to adjust cable entry or exit position
- Mounts on 19" or 23" rack; may also be wall-mounted
- Strong lightweight aluminum construction

| Part Number | | Description | Shipping Weight lb (kg) |
|-------------|-----------|-----------------------------------|-------------------------|
| 19" | 23" | | |
| 12183-X19 | 12183-X23 | Upper Tray, 3.5"D (89 mm) | 3 (1.4) |
| 13183-X19 | 13183-X23 | Upper Tray, 6"D (150 mm) | 4 (1.8) |
| 12185-X19 | 12185-X23 | Lower Tray, Single, 3.5"D (89 mm) | 4 (1.8) |
| 12187-X19 | 12187-X23 | Lower Tray, Double, 3.5"D (89 mm) | 5 (2.3) |
| 12186-X01 | N/A | Transition Plate, 15.5"L (394 mm) | 2 (0.9) |

X=color: 1=Gray, 2=Computer Beige, 5=Clear, 7=Black, E=Glacier White.

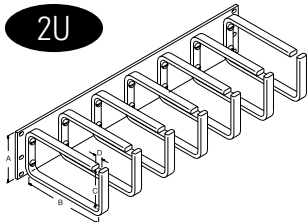

- A 3.47" (88.1 mm)
- B 6.20" (157.4 mm)
- C 2.85" (72.4 mm)
- D 0.56" (14.2 mm)

Large Horizontal Ring Panel

Used to organize horizontal cable runs. Large 2.8"H (71 mm) by 6"W (150 mm) heavy duty aluminum rings with rounded edges protect cable sheaths and will not bind during installation. Rings are bolted onto panels, so they can be added or removed as needed. 19" and 23" wide rack panel options come pre-assembled with seven equally spaced rings.

- 2.8"H x 6"W (71 mm x 150 mm) heavy duty aluminum rings
- Rings can be added or removed as needed
- Installation hardware not included
- Shipping weight approximately 5 lb (2.3 kg)

| Part Number | | Description |
|-------------|-----------|-------------|
| 19" | 23" | |
| 11564-X19 | 11564-X23 | Ring Panel |

X=Color: 1=Gray, 2=Computer Beige, 5=Clear, 7=Black, E=Glacier White.

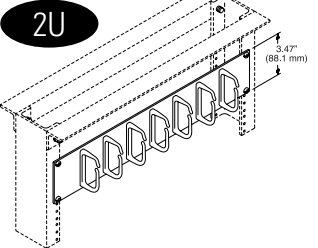
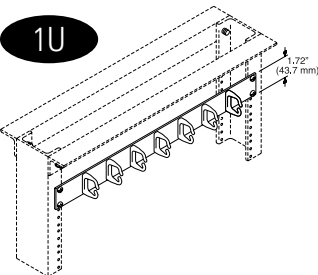

Rack Cabling Managers

Used to organize horizontal cable and wire runs. Two sizes of slotted plastic rings provide ample room to hold all types and sizes of wiring and cabling.

- Easy to install on equipment racks
- Installation hardware not included

| Part Number | Description Width - in (mm) |
|-------------|--|
| 11752-X19 | 19"W Rack, 1U, 1.6 x 1.3 (41 x 33) Rings |
| 11752-X23 | 23"W Rack, 1U, 1.6 x 1.3 (41 x 33) Rings |
| 11753-X19 | 19"W Rack, 2U, 3 x 1.6 (80 x 41) Rings |
| 11753-X23 | 23"W Rack, 2U, 3 x 1.6 (80 x 41) Rings |

X=Color: 1=Gray, 2=Computer Beige, 5=Clear, 7=Black, E=Glacier White.

Slip-On Cover, Ring Panel

The Slip-On Cover is used on the Large Horizontal Ring Panel, P/N 11564-XXX. Sold individually.

| Part Number | Description Width - in (mm) | Shipping Weight lb (kg) |
|-------------|------------------------------------|----------------------------|
| 11764-X19 | Slip-On Cover, 19"W, for 11564-X19 | 2 (0.9) |
| 11764-X23 | Slip-On Cover, 23"W, for 11564-X23 | 2 (0.9) |

Closed Composite Distribution Rings

With Distribution Rings, all your wiring and cabling can now be neatly and easily organized and managed. Designed to support cable and wire in communication closets, on backboards, equipment racks or wherever cable runs are required. The versatile brackets are made of high-strength, fire-retardant composite material. Rounded edges prevent damage to cable and wire insulation, while providing easy pull-through.

Mounting hole configuration allows brackets to be attached to most surfaces, including CPI equipment racks. Color is compatible with most equipment. Mounting hardware not included.

- Strong, lightweight, fire-retardant composite material construction
- Easy to install onto CPI equipment racks or backboards
- Rounded shape eliminates cable nicks, great for wire pulling

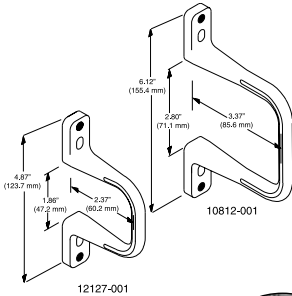

| Part Number | | Description | Shipping Weight lb (kg) |
|-------------|------------|------------------------|----------------------------|
| Each | Box of 100 | | |
| 12127-001 | 12127-011 | 2 (50) Closed "D" Ring | 6 (2.7) |
| 10812-001 | 10812-011 | 3 (80) Closed "D" Ring | 9 (4.1) |

Color is gray. Shipping Weights are for Box of 100.

Metal D-Rings

A convenient and economical way to route, support and secure cables and jumper wires in terminal closets or wherever cable runs are required.

- Offered in three standard sizes
- Made from 1/8" x 1/2" (3.18 mm x 13 mm) hot-rolled steel strap with zinc plating to resist corrosion
- Ring edges are rolled to prevent nicks and scratches in the cable and wire insulation
- Mounting hardware not included

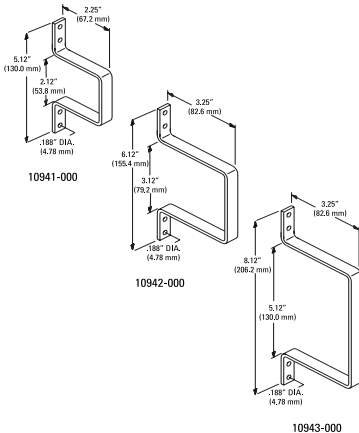

| Part Number | | Description | Shipping Weight lb (kg) |
|-------------|------------|--------------|----------------------------|
| Each | Box of 100 | | |
| 10941-000 | 10941-010 | Small Rings | 16 (7.3) |
| 10942-000 | 10942-010 | Medium Rings | 22 (10.0) |
| 10943-000 | 10943-010 | Large Rings | 24 (10.9) |

Shipping Weights are for Box of 100.

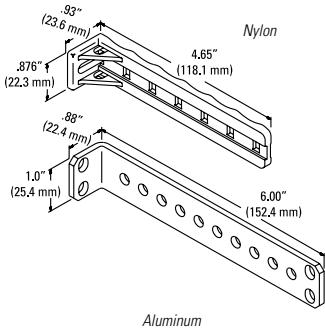

Stand-Off Tie Bracket

These brackets mount to the back of the rack channel to provide a convenient point to tie-down cable runs.

- Choice of either non-conductive nylon or high-strength aluminum
- Either end of the aluminum bracket can be attached to rack, allowing cabling to run several different ways
- Mounting hardware not included

| Part Number | | Description | Shipping Weight lb (kg) |
|-------------|-----------|-------------------------------|-------------------------|
| Each | Box of 50 | | |
| 10001-001 | 10001-050 | 1 x 5 (30 x 130), White Nylon | 3 (1.4) |
| 10559-X00 | 10559-X50 | 1 x 6 (30 x 150), Aluminum | 5 (2.3) |

X=color: 1=Gray, 2=Computer Beige, 5=Clear, 7=Black, E=Glacier White. Shipping Weights are for Box of 50.

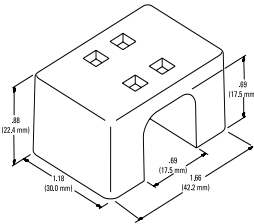

Mag-Clips, Medium Sized

The medium-sized 17000 and 17100 magnetic clips are designed to hold a 25-pair cable or several electrical cords. Keeps cables within workstation areas neat and off of the floor to reduce the chance of accidents. Nylon cable ties can be laced through the four square holes in the top of the 17000 series to secure additional cables.

| Part Number | | Description | Shipping Weight lb (kg) |
|-------------|-----------|--------------------|-------------------------|
| Each | Box of 50 | | |
| 17000-X00 | 17000-X50 | Clip With Holes | 7 (3.2) |
| 17100-X00 | 17100-X50 | Clip Without Holes | 7 (3.2) |

X=color: 0=Gray, 1=Computer Beige. Shipping Weights are for Box of 50.

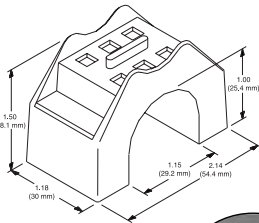

Mag-Clips, Large

This larger clip holds a 100-pair telephone cable or up to 1" (30 mm) diameter tubing. There are also holes provided to lace additional cords to the top of the clip. The amount of direct pull required to separate the clips from a painted steel surface averages 15 lb (67 kg).

| Part Number | | Description | Shipping Weight lb (kg) |
|-------------|-----------|-------------|-------------------------|
| Each | Box of 25 | | |
| 17500-X00 | 17500-X20 | Clip | 7 (3.2) |

X=color: 0=Gray, 1=Computer Beige. Shipping Weights are for Box of 25.

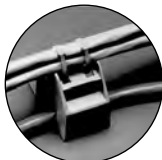



SECTION 3

CABLE RUNWAY & TRAY PRODUCTS

| | | | |
|--------------------------------------|------|--|------|
| Cable Runway..... | 3-3 | Cable Runway Accessories | 3-23 |
| Cable Runway Junction Products..... | 3-11 | Wire Mesh Cable Tray System | 3-30 |
| Cable Runway Mounting Products | 3-15 | Wire Mesh Cable Tray Accessories | 3-32 |
| Cable Runway Support Products | 3-17 | | |

CABLE RUNWAY & TRAY PRODUCTS

Section Update:

- Patented Tool-less Pathway Dividers Page 3-5
- PEMSA® Rejiband® Wire Mesh Cable Tray System Page 3-30
- PEMSA® Rejiband® Wire Mesh Cable Tray System Support Accessories Page 3-32

Where Can I Learn More?

To learn more about CPI's Cable Runway and Tray Products, or to find additional part numbers not listed in this catalog, please visit our website, chatsworth.com

Related Tools:

Use these tools, under the Resources tab on chatsworth.com, to simplify your planning, selection, order and purchase of order and purchase of CPI Cable Runway and Tray Products.

- Visio Shapes
- CAD Blocks
- BIM Drawings
- Cable Fill
- MasterFormat Specs
- OSHPD Products

Your Notes Here:



**PEMSA® Rejiband® Wire Mesh
Cable Tray System**

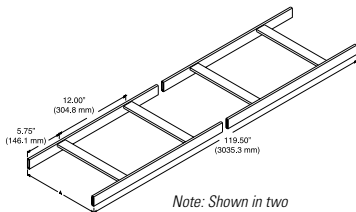
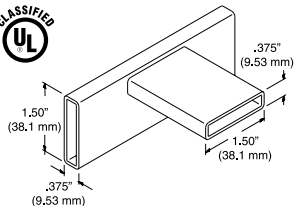

Note: Shown in two sections for illustrative purposes, actual product is one piece.

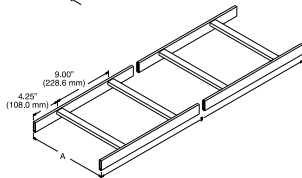
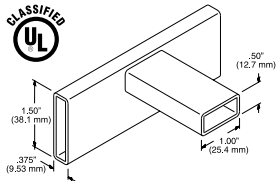

Note: Shown in two sections for illustrative purposes, actual product is one piece.

Universal Cable Runway

Designed for value-conscious customers, the Universal Cable Runway offers the industry-standard features you have come to expect. With the runway supported every 5' (1.5 m), maximum load with minimal deflection is 132 lb/ft (196 kg).

- Made of 3/8" x 1-1/2" x .065" (9.53 mm x 38.1 mm x 1.65 mm) wall rectangular steel tubing, Cross members welded at 12" (300 mm) intervals
- Standard length is 9'-11 1/2"/119.5" (3035 mm)
- UL Classified for suitability as an equipment bonding conductor only (must remove paint or use ground straps)
- Installation Best Practices includes Runway Elevation Kit

| Part Number | Description Width (Dim. A) in (mm) | Shipping Weight lb (kg) |
|-------------|------------------------------------|-------------------------|
| 10250-X04 | 4 (100) | 18 (8.2) |
| 10250-X06 | 6 (150) | 19 (8.6) |
| 10250-X09 | 9 (230) | 20 (9.1) |
| 10250-X12 | 12 (300) | 25 (11.3) |
| 10250-X15 | 15 (380) | 27 (12.2) |
| 10250-X18 | 18 (460) | 29 (13.2) |
| 10250-X24 | 24 (610) | 32 (14.5) |
| 10250-X31 | 30 (760) | 35 (15.7) |
| 10250-X37 | 36 (910) | 38 (17.2) |

X=finish; 1=Gray, 2=Computer Beige, 7=Black, E=Glacier White.

UL Classified Cable Runway

Similar in construction to our TELCO-Style Cable Runway (11252 series). The side stringers are 1 1/2" x 3/8" x .065" (38.1 mm x 9.53 mm x 1.65 mm), and the cross members are 1/2" x 1" x .065" (12.7 mm x 30 mm x 1.65 mm), welded at 9" (230 mm) intervals.

- Available in Gold chem finish or Black chem over zinc plating
- UL Classified for suitability (as an equipment grounding conductor only)
- The overall length is 9' 8-1/2"/116.5" (2959 mm) to comply with TELCO-Style standards
- Individually boxed to prevent scratching and damage
- Installation Best Practices include Runway Elevation Kit

| Part Number | Width (Dim. A) in (mm) | Length (Dim. B) in (mm) | Shipping Weight lb (kg) |
|-------------|------------------------|-------------------------|-------------------------|
| 11275-X06 | 6 (150) | 9' 8-1/2 (2959) | 19 (8.6) |
| 11275-X09 | 9 (230) | 9' 8-1/2 (2959) | 20 (9.1) |
| 11275-X12 | 12 (300) | 9' 8-1/2 (2959) | 22 (10.0) |
| 11275-X15 | 15 (380) | 9' 8-1/2 (2959) | 26 (11.8) |
| 11275-X18 | 18 (460) | 9' 8-1/2 (2959) | 28 (12.7) |
| 11275-X20 | 20 (510) | 9' 8-1/2 (2959) | 29 (13.2) |
| 11275-X24 | 24 (610) | 9' 8-1/2 (2959) | 31 (14.1) |

X=color over zinc: 0=Gold Chem, 7=Black

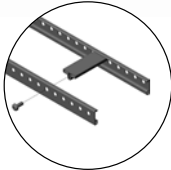

Adjustable Runway Cross Members

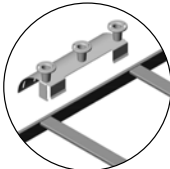

Highly Adaptable with Tool-less Cable Management Accessories

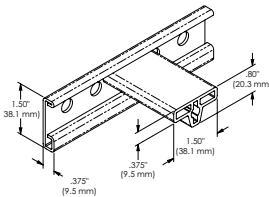

Adjustable Cable Runway

Designed to provide a flexible point-to-point solution anywhere cables enter or exit the cable pathway. The Adjustable Cable Runway features unique, movable Cross Members, which allow components and accessories to be installed at various points along the runway—a feature that simplifies the alignment of cabling above racks, cabinets and cable managers. The Adjustable Cable Runway is cross-compatible with CPI's Universal (10250), TELCO (11252) and UL Classified (11275) runway, making it an excellent solution for any challenging cabling environment.

Features:

- Features movable Cross Members for ultimate cable pathway customization
- Supports cable and fiber from floors, ceilings, walls and the tops of cabinets and racks
- Simplifies moves, adds and changes
- Supports tool-less accessories for quick and easy deployment
- Complements other CPI Runway Systems
- Adapts to any data center or computer room
- Ships assembled or unassembled
- Bonded construction

Specifications:

- Includes roll-formed Stringers with bolted aluminum Cross Members
- 132 lb/ft (196 kg/m) when the runway is supported every 5' (1.5 m)
- For indoor use only, in environmentally controlled areas
- Stringers: 119.5" (3085 mm) high-strength, low-alloy steel with 1: (25 mm) repeating-hole pattern and rounded corners
- Cross Members: 0.80" x 1.5" (20.3 mm x 38 mm) extruded aluminum, T-shaped Cross Members
- Thread-forming screws cut through paint to form electrical bond between Stringers and Cross Members
- Use with CPI Bonding and Grounding products for ANSI/TIA-942-A-B compliance
- Includes: (2) Stringers; (10) Cross Members (20) M8 x 20, Taprite Thread-forming Hexalobular (T-30) Screws
- UL Classified for suitability as an equipment bonding conductor only (must remove paint or use ground straps)

| Part Number | Adjustable Cable Runway 1.5" H x 119.5" L (38 mm x 3035 mm) Assembled, Width - in(mm) | Shipping Weight lb (kg) |
|-------------|---|----------------------------|
| 14300-X04 | 4 (102) | 17 (8) |
| 14300-X06 | 6 (152) | 18 (8) |
| 14300-X09 | 9 (229) | 19 (8) |
| 14300-X12 | 12 (305) | 20 (9) |
| 14300-X15 | 15 (381) | 21 (10) |
| 14300-X18 | 18 (457) | 22 (10) |
| 14300-X24 | 24 (610) | 25 (11) |
| 14300-X30 | 30 (762) | 27 (12) |
| 14300-X36 | 36 (914) | 30 (13) |

Notes: X=color: 1=Gray, 2=Computer Beige, 7=Black, E=Glacier White

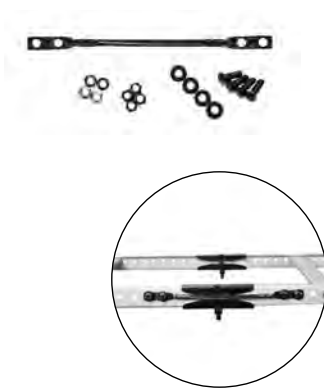

Adjustable Cable Runway Bonding Strap

The Adjustable Cable Runway Bonding Strap provides a bonding pathway between runway lengths. It consists of an 8" L (200 mm) #6 AWG stranded insulated copper conductor and are attached to a two-hole compression lug with 5/16" bolt holes at both ends. Bolt holes are spaced on 1" (25 mm) centers to match hole-to-hole spacing on the Adjustable Cable Stringers.

- Overall length 10.8" (273 mm)
- UL Listed Components
- Hardware includes: (4) Stainless steel cap screws, #5/16-18 x 7/8" L; (4) Flat washers, 5/16", (4) Lock washers, 5/16" and (4) Nuts, 5/16"

| Part Number | Description | Shipping Weight lb (kg) |
|-------------|---|-------------------------|
| 14307-001 | Bonding Strap Kit, 10.8" L (273 mm), Each | 1 (0.5) |
| 14307-025 | Bonding Strap Kit, 10.8" L (273 mm), Pack of 25 | 25 (11.4) |

Note: Hole-to-hole spacing aligns with prepunched holes on Adjustable Cable Runway Stringers without drilling. Also compatible with all CPI Runway systems.

PATENTED



Pathway Dividers feature Click Secure Technology

Tool-less Pathway Dividers

The patented Tool-less Pathway Dividers divide cable runway into multiple pathways to organize cables by media type or destination—a solution that enables technicians to better manage moves, adds and changes. Hinged design opens up to wrap around cross members and features CPI's Click Secure Technology.

- Compatible with all styles of CPI Runway
- Manufactured from polycarbonate/acrylonitrile butadiene styrene (PC/ABS) material
- UL 94-V0 flammability rating for optimum impact and heat resistance
- Sold in packs of 10 and 100; Finish: Black

| Part Number | Description | Shipping Weight lb (kg) |
|-------------|--------------------------------|-------------------------|
| 14308-001 | 6" H (152), Pack of 10, Black | 2 (1.0) |
| 14308-002 | 6" H (152), Pack of 100, Black | 15 (7.0) |

PatchRack For CPI Cable Runway

The PatchRack is a miniature two-post rack that can be attached to CPI Cable Runway to save rack-mount space by placing patch panels or interconnect equipment above the rack or cabinet. Use PatchRack to create a zone network in the data center.

Two versions are available; Racks P/N 13395 attach to the Cable Runway side stringer with a 7"D (180 mm) standoff bracket, and Racks P/N 13394 attach to a cross member underneath the Cable Runway. The position of the rack can be adjusted front-to-back or side-to-side. Racks P/N 13395 can also attach perpendicular to Cable Runway that is 12"W (300 mm) or less. Use the Cross Member Hardware Kit P/N 13399-702 for perpendicular mounting of all racks on any width of Cable Runway.

- Attaches to all CPI Cable Runway but optimized for 1-1/2"H x 3/8"W (38.1 mm x 9.53 mm) side stringers or cross members to Universal Cable Runway
- Supports 19"W rack-mount equipment; supports up to 60 lb (27.2 kg)
- Side Stringers (P/N 13395) are compatible with all styles of CPI Runway; Cross Members (P/N 13394) are not compatible with Adjustable Cable Runway



P/N 13395



P/N 13394

| Part Number | Description | Shipping Weight lb (kg) |
|-------------|---------------------------------|-------------------------|
| 13395-X04 | With Side Stringer Brackets, 4U | 5 (2.3) |
| 13395-X08 | With Side Stringer Brackets, 8U | 7 (3.2) |
| 13394-X04 | With Cross Member Brackets, 4U* | 4 (1.8) |
| 13394-X08 | With Cross Member Brackets, 8U* | 6 (2.7) |

*X=*color: 1=Gray, 2=Computer Beige, 5=Clear, 7=Black, E=Glacier White. Computer Beige kits include gold colored hardware. Gray and Black kits include black colored hardware. Does not include Side Stringer Brackets. *Attaches to Cross Member in parallel orientation only.

Accessories For PatchRack

Use Cross Member Hardware Kit for perpendicular mounting on all widths of Cable Runway. The D-Ring Kit provides cable management.

- Not compatible with Adjustable Cable Runway

| Part Number | Description | Shipping Weight lb (kg) |
|-------------|--------------------------------------|-------------------------|
| 13399-X02 | Cross Member Hardware Kit, Black | 1 (0.5) |
| 13396-204 | D-Rings for 4U Rack, 6 Rings, Beige | 1 (0.5) |
| 13396-208 | D-Rings for 8U Rack, 10 Rings, Beige | 2 (0.9) |
| 13396-704 | D-Rings for 4U Rack, 6 Rings, Black | 2 (0.9) |
| 13396-708 | D-Rings for 8U Rack, 10 Rings, Black | 2 (0.9) |

Notes: X=color: 2=Computer Beige, 7=Black



P/N 13399-X02
Shown installed
on right.

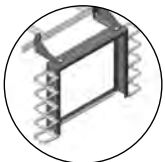

P/N 13396-XXX
Shown installed
on left.

PATENT
PENDING

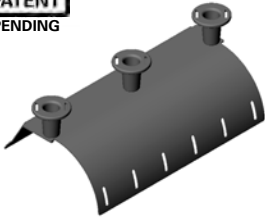

Tool-less Cross Member Radius Drop

The Tool-less Cross Member Radius Drop is designed for compatibility with 1.5" x 3/8" (38 mm x 9.53 mm) Stringers and installs without the need for tools, mounting directly to the sides of the runway.

- May be positioned over or between the Runway Cross Members
- Use hook-and-loop, along with the tie-down slots to fully deploy the cable support solutions
- Provides 3" (76.2 mm) bend radii; Includes 1.4"H (36 mm), 1" (25 mm) diameter ABS cable spools to separate and guide cables
- Compatible with all styles of CPI Runway
- Manufactured from steel; spools are plastic
- For appropriate fit, match Cross Member Radius Drop width to runway width

| Part Number | Description | Shipping Weight lb (kg) |
|-------------|----------------------------|-------------------------|
| 14304-X04 | 4"W (102), Each, 2 Spools | 2 (1.0) |
| 14304-X06 | 6"W (152), Each, 2 Spools | 2 (1.0) |
| 14304-X09 | 9"W (229), Each, 2 Spools | 2 (1.0) |
| 14304-X12 | 12"W (305), Each, 3 Spools | 3 (1.5) |
| 14304-X15 | 15"W (381), Each, 3 Spools | 3 (1.5) |
| 14304-X18 | 18"W (457), Each, 3 Spools | 4 (2.0) |
| 14304-X24 | 24"W (610), Each, 3 Spools | 6 (3.0) |
| 14304-X30 | 30"W (762), Each, 3 Spools | 7 (3.0) |
| 14304-X36 | 36"W (914), Each, 5 Spools | 7 (3.0) |

Notes: X=color: 1=Gray, 2=Computer Beige, 7=Black, E=Glacier White

PATENT
PENDING

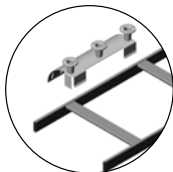

Tool-less Stringer Radius Drop

The Tool-less Stringer Radius Drop features simple, tool-less installation.

- Use hook-and-loop, along with the tie-down slots to fully deploy the cable support solutions.
- Provides 3" (76.2 mm) bend radii
- Supplied with 1.4"H (36 mm), 1" (25 mm) diameter, cable spools to separate and guide cables
- Unique design slips over the Runway Stringers and clamps in position; fits Runway Stringers that are 1-1/2"H x 3/8"W (38 mm x 9.53 mm)
- Compatible with all CPI Runway systems

| Part Number | Description | Shipping Weight lb (kg) |
|-------------|-----------------------------------|-------------------------|
| 14305-X00 | Large, 10.5 (268), Each, 3 Spools | 3 (1.0) |
| 14305-X01 | Small, 5.5 (140), Each, 2 Spools | 2 (1.0) |

Notes: X=color: 1=Gray, 2=Computer Beige, 7=Black, E=Glacier White

Cable Runway Radius Drop

Mounts to the side stringer or cross member of CPI Cable Runway to help maintain proper Category 5e/6/6a or fiber bend radii.

- Cross Member Radius Drop (P/N 12100-XXX) fits 6", 9", 12" and 18"W (150 mm, 230 mm, 300 mm and 460 mm) cross member tubing on CPI Universal Runway (Series 10250)
- Stringer Radius Drop (P/N 12101-XXX) attaches to the side or straddles the rungs of the runway cross member
- Provides 3" (80 mm) bend radius
- Products 5"W (130 mm), 12100-X06, 12101-X03, drop into CPI's 6"W (150 mm) vertical cabling sections
- Supplied with 1-1/2" (38.1 mm) cable spools (P/N 15003-001) to separate and guide cables
- Sold individually

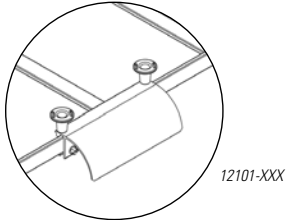
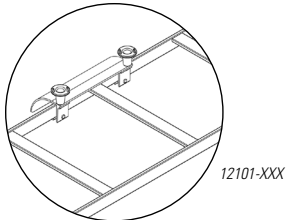
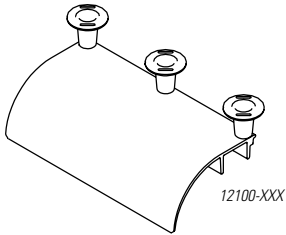

| Part Number | Cable Runway Width - in (mm) | Product Width in (mm) | Cable Spools |
|---|------------------------------|-----------------------|--------------|
| Runway Radius Drop, Cross Member | | | |
| 12100-X06 | 6 (150) | 5 (130) | 2 each |
| 12100-X09 | 9 (230) | 8 (200) | 2 each |
| 12100-X12 | 12 (300) | 11 (280) | 3 each |
| 12100-X18 | 18 (460) | 17 (430) | 3 each |

| Part Number | | Runway Application | Product Width in (mm) | Cable Spools |
|---|--------------------------|--------------------|-----------------------|--------------|
| Attaches to Side | Attaches to Side or Ring | | | |
| Runway Radius Drop, Stringer, Adjustable | | | | |
| 12101-X01 | 12101-X11 | Universal | 10.3 (260) | 2 each |
| 12101-X02 | 12101-X12 | Telco | 7.8 (197) | 2 each |
| 12101-X03 | 12101-X13 | Misc. | 5 (130) | 3 each |

X=Color: 1=Gray, 2=Computer Beige, 7=Black, E=Glacier White.

Cable Runway Movable Cross Member

Permits the dropping of cables at any point between cross members of 9", 12" or 18"W (230 mm, 300 mm or 460 mm) Cable Runways. Combine with the recommended Cable Runway Radius Drop.

- Fits on standard Cable Runway only — 1-1/2" x 3/8" stringer (38.1 mm x 9.53 mm)
- Can be used as an attachment point for the Cable Runway Radius Drops listed below
- Easy installation using provided hardware

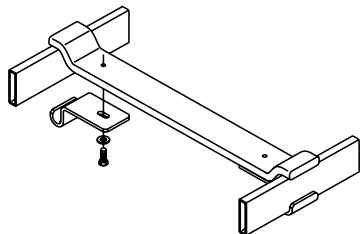

| Part Number | Cable Runway in (mm) | Use with Radius Drop |
|-------------|----------------------|----------------------|
| 12115-X09 | 9 (230) | 12100-X06 |
| 12115-X12 | 12 (300) | 12100-X09 |
| 12115-X18 | 18 (460) | 12100-X12 |

X=Color: 1=Gray, 2=Computer Beige, 7=Black, E=Glacier White. Computer Beige kits have gold colored hardware. Gray (-1XX) and Black (-7XX) kits have black colored hardware.

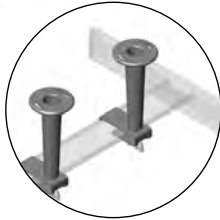

Cable Runway Dividers

Divide Cable Runway into multiple cable pathways in order to organize cables according to media type or destination. By organizing horizontal cables by destination according to route or zone, technicians can better manage cables when additional cables are added, or when the cable path through the building changes due to building renovations.

- Cable spools separate cables into individual pathways for better organization of cables
- Spools have a smooth surface to protect cable jackets from damage during installation or maintenance
- Easy installation with included hardware
- Universal/Trough Style Dividers fit 3/8" H x 1-1/2" W (9.53 mm x 38.1 mm) cross members on CPI Universal or Trough Cable Runway
- TELCO/UL Classified Style Dividers fit 1/2" H x 1" W (13 mm x 30 mm) cross members on CPI TELCO or UL Classified Cable Runway

| Part Number | Description | Shipping Weight lb (kg) |
|--|------------------------|----------------------------|
| Universal or Trough Style Dividers | | |
| 13392-X11 | Divider, Package of 5 | 1 (0.5) |
| 13392-X12 | Divider, Package of 25 | 3 (1.4) |
| TELCO or UL Classified Style Dividers | | |
| 13392-X21 | Divider, Package of 5 | 1 (0.5) |
| 13392-X22 | Divider, Package of 25 | 3 (1.4) |

X=finish; 7=Black, E=Glacier White. Cable spool is black.

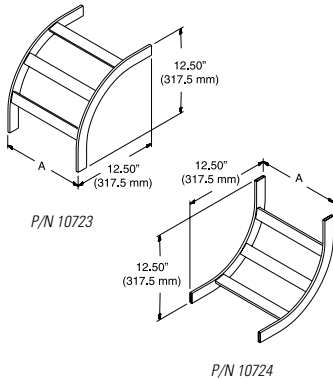

Cable Runway Radius Bend

Creates a gradual bend for cascading cable runs.

- Made of lightweight 1-1/2" x 3/8" (38.1 mm x 9.53 mm) tubular steel
- Three cross members welded at approximately 23° increments
- Outside/Inside is determined by welding cross members closer to cable side

| Part Number 90° Outside Bend | Part Number 90° Inside Bend | Width (Dim. A) in (mm) |
|---------------------------------|--------------------------------|---------------------------|
| 10723-X04 | 10724-X04 | 4 (100) |
| 10723-X06 | 10724-X06 | 6 (150) |
| 10723-X08 | 10724-X08 | 8 (200) |
| 10723-X09 | 10724-X09 | 9 (230) |
| 10723-X10 | 10724-X10 | 10 (250) |
| 10723-X12 | 10724-X12 | 12 (300) |
| 10723-X15 | 10724-X15 | 15 (380) |
| 10723-X18 | 10724-X18 | 18 (460) |
| 10723-X20 | 10724-X20 | 20 (510) |
| 10723-X24 | 10724-X24 | 24 (610) |
| 10723-X31 | 10724-X31 | 30 (760) |
| 10723-X37 | 10724-X37 | 36 (910) |

X=Color, 0=Gold, 1=Gray, 2=Computer Beige, 7=Black, E=Glacier White. Only gold radius bends are UL Classified.

Cable Runway E-Bend

Creates a 90° gradual sweep in horizontal plane for Cable Runway runs. Designed for cabling in conformance with minimum bend radii requirements (typically 4 times the cable diameter). Made of lightweight 1-1/2" x 3/8" (38.1 mm x 9.53 mm) tubular steel to fit standard Cable Runway. Cross members welded at approximately 23° increments.

- Conforms to cable bend radii requirements
- Easy installation using CPI Butt-Splices (P/N 11301-001, not included)

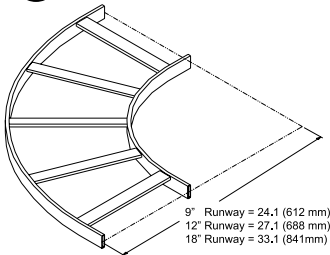

| Part Number | Cable Runway Width in (mm) | Width (Dim. B) in (mm) |
|-------------|-------------------------------|---------------------------|
| 10822-X04 | 4 (100) | 19.1 (485) |
| 10822-X06 | 6 (150) | 21.1 (536) |
| 10822-X08 | 8 (200) | 23.1 (587) |
| 10822-X09 | 9 (230) | 24.1 (612) |
| 10822-X10 | 10 (250) | 25.1 (638) |
| 10822-X12 | 12 (300) | 27.1 (688) |
| 10822-X15 | 15 (380) | 30.1 (765) |
| 10822-X18 | 18 (460) | 33.1 (841) |
| 10822-X20 | 20 (510) | 35.1 (892) |
| 10822-X24 | 24 (610) | 39.1 (993) |
| 10822-X31 | 30 (760) | 45.1 (1146) |
| 10822-X37 | 36 (910) | 51.1 (1298) |

X=Color, 0=Gold, 1=Gray, 2=Computer Beige, 7=Black, E=Glacier White. Only gold E-Bends are UL Classified.

All part numbers listed on this page are compatible with all styles of CPI Runway.

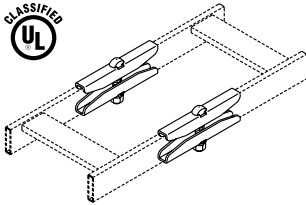

Butt-Splice Kit

Connect two sections of runway end-to-end. Fits both solid and tubular steel 1-1/2" x 3/8" and 2" x 3/8" (38.1 mm x 9.53 mm and 50.8 mm x 9.53 mm).

- Part numbers are compatible with Adjustable Cable Runway except P/N 11301-X02
- Kit includes:**
- (4) splice plates; (2) 3/8-16 trimmed head bolts; (2) 3/8-16 hex nuts; (2) 3/8" split lock washers

| Part Number | Description in (mm) | Shipping Weight lb (kg) |
|-------------|---|-------------------------|
| 11301-X01* | Butt-Splice Kit, 1-1/2 x 3/8 (38 x 9.53) Stringer | 1 (0.5) |
| 11301-X02* | Butt-Splice Kit, 2 (50.8) Stringer | 1 (0.5) |
| 16301-X01* | UL Classified Butt-Splice Kit | 1 (0.5) |

*X=color over zinc: 0=Gold, 7=Black. Gold kits include gold colored hardware. Black kits include black colored hardware.

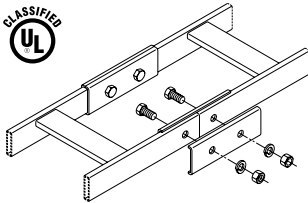

Heavy-Duty Butt-Splice Kit

For butting two lengths of Runway together. Cable Runway drilling is required.

- Bolt through Butt-Splice Kit for earthquake areas
- Not compatible with Adjustable Cable Runway

Kit includes:

- (4) splice plates for 1-1/2" stringers; (4) 3/8-16 x 1-1/4" hex cap screws; (4) 3/8-16 hex nuts; (4) 3/8" split lock washers

| Part Number | Description | Shipping Weight lb (kg) |
|-------------|--|-------------------------|
| 11299-X01* | Heavy-Duty Butt-Splice Kit | 2 (0.9) |
| 16299-X01* | UL Classified Heavy-Duty Butt-Splice Kit | 2 (0.9) |

*X=color over zinc: 0=Gold, 7=Black. Gold kits include gold colored hardware. Black kits include black colored hardware.

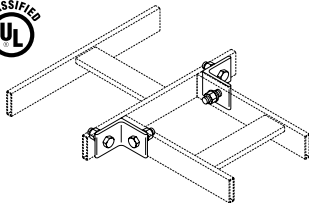

Heavy-Duty Junction-Splice Kit

Bolt-through Junction-Splice Kit for vertical runs or to meet seismic requirements. Cable Runway drilling is required.

- Material is 2" x 2" x 3/16" (50 mm x 50 mm x 4.763 mm) steel angle
- Not compatible with Adjustable Cable Runway

Kit includes:

- (2) splice angles; (4) 3/8-16 x 1-1/4" hex cap screws; (4) 3/8-16 hex nuts; (4) 3/8 split lock washers

| Part Number | Description | Shipping Weight lb (kg) |
|-------------|----------------------------|-------------------------|
| 11298-X01* | Heavy-Duty Junction Splice | 3 (1.4) |
| 16298-X01* | UL Classified Junction Kit | 3 (1.4) |

*X=color over zinc: 0=Gold, 7=Black. Gold kits include gold colored hardware. Black kits include black colored hardware.

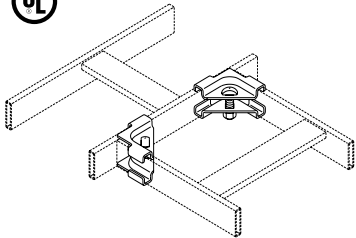

Junction-Splice Kit

Used to create a 90° junction splice with all types of 1-1/2" x 3/8" or 2" x 3/8" (38.1 mm x 9.53 mm and 50.8 mm x 9.53 mm) Cable Runway.

• Part numbers are compatible with Adjustable Cable Runway except P/N 11302-X02

Kit includes:

- (4) corner clamp plates; (2) 3/8-16 x 1 3/8" trimmed head bolts; (2) 3/8-16 hex nuts; (2) 3/8 split lock washers

| Part Number | Description in (mm) | Shipping Weight lb (kg) |
|-------------|--|-------------------------|
| 11302-X01 | Junction-Splice Kit 1-1/2 x 3/8 (38mm x 9.53) Stringer | 1 (0.5) |
| 11302-X02 | Junction-Splice Kit 2 x 3/8 (50.8 x 9.53) Stringer | 1 (0.5) |
| 16302-X01 | UL Classified Junction Kit | 1 (0.5) |

X=color over zinc: 0=Gold, 7=Black

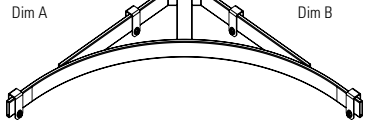

| Dimension | 15" W (380 mm) in (mm) | 24"W (610 mm) in (mm) |
|-----------|------------------------|-----------------------|
| A | 15.48 (393.2) | 24.13 (612.9) |
| B | 15.48 (393.2) | 24.13 (612.9) |

Cable Runway Corner Bracket

Creates a radius for L, T or X-shaped intersections of Cable Runway formed when two or more pieces of Cable Runway are connected together with the Junction-Splice Kit (P/N 11302 or 16302) or Heavy-Duty Junction-Splice Kit (P/N 11298 or 16298).

- Single-piece welded assembly fabricated from 3/8" x 1-1/2" x .065" (9.53 mm x 38.1 mm x 1.65 mm) wall rectangular steel tubing
- Easy installation; brackets/hardware included
- Compatible with Adjustable Cable Runway

| Part Number 15"W (380 mm) | Part Number 24"W (610 mm) | Description |
|---------------------------|---------------------------|----------------|
| 11959-X15 | 11959-X24 | Corner Bracket |

X=color over zinc: 0=Gold, 1=Gray, 2=Computer Gray, 7=Black, E=Glacier White.

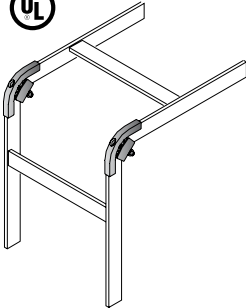

90° Runway-Splice Kit

Designed to butt-splice 1-1/2" (38.1 mm) Cable Runway at a 90° angle.

- Compatible with Adjustable Cable Runway Kit includes:
- (2) 90° outside clamps; (2) Inside edge clamps; (2) 3/8-16 trimmed round head, square neck bolts; (2) 3/8-16 hex nuts and lock washers

| Part Number | Description in (mm) | Shipping Weight lb (kg) |
|-------------|---|-------------------------|
| 11314-X01 | 90° Runway-Splice Kit, 1-1/2 x 3/8 (38.1 x 9.53) stringer | 1 (0.5) |
| 16314-X01 | UL Classified 90° Runway-Splice Kit | 1 (0.5) |

X=color over zinc: 0=Gold, 7=Black

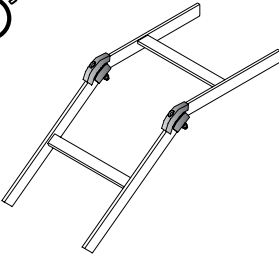

45° Runway-Splice Kit

Butt-splices Cable Runway at a 45° angle.

- Compatible with Adjustable Cable Runway

Kit includes:

- (2) 45° outside clamps; (2) Inside edge clamps; (2) 3/8-16 trimmed round head, square neck bolts; (2) 3/8-16 hex nuts and lock washers

| Part Number | Description in (mm) | Shipping Weight lb (kg) |
|-------------|---|-------------------------|
| 11313-X01 | 45° Runway-Splice Kit, 1-1/2 x 3/8 (38.1 x 9.53) stringer | 1 (0.5) |
| 16313-X01 | UL Classified 45° Runway-Splice Ki | 1 (0.5) |

X=color over zinc: 0=Gold, 7=Black

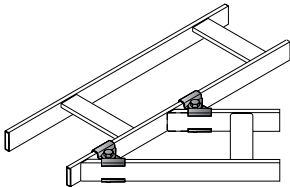

Adjustable Junction-Splice Kit

Adjusts to form any junction angle for cabling that requires a large radius bend or to route around existing plumbing, electrical, etc.

- Compatible with Adjustable Cable Runway Kit includes:
- (4) adjustable corner plates; (2) 3/8-16 x 2" hex cap screws; (2) 3/8-16 hex nuts; (2) 3/8 lock washers

Note: Requires one kit to attach one end of cable runway.

| Part Number | Description | Shipping Weight lb (kg) |
|-------------|--------------------------------|-------------------------|
| 10616-X01 | Adjustable Junction Splice Kit | 2 (0.9) |

X=color over zinc: 0=Gold, 7=Black

Swivel Splice Kits

Splices cable runway vertically, horizontally or perpendicularly. Flexible swivel design adjusts to any angle, not limited to 45° or 90°. Material is steel. Hardware and instructions are included.

- Compatible with Adjustable Cable Runway

Butt Swivel (10487) Kit includes:

- (8) bracket end; (8) 5/16-18 x 3/4" round head square, neck bolts; (2) 5/16-18 x 1" round head square, neck bolts; (10) 5/16-18 hex nuts, split lock washers

Junction Swivel (10488) Kit includes:

- (4) bracket end; (2) bracket supports and plate clamps; (2) 5/16-18 x 1" round head square, neck bolts; (8) 5/16-18 x 3/4" round head square, neck bolts; (10) 5/16-18 hex nuts, split lock washers

Vertical Swivel (10489) Kit includes:

- (4) bracket end; (2) bracket clamps and plate clamps; (2) 5/16-18 x 1" round head, square neck bolts; (6) 5/16-18 x 3/4" round head, square neck bolts; (8) 5/16-18 hex nuts, split lock washers

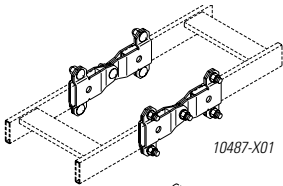

10487-X01

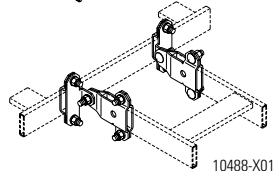

10488-X01

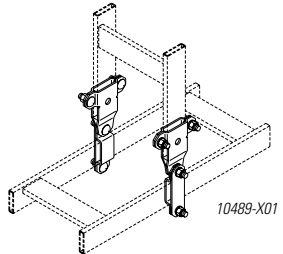

10489-X01

| Part Number | Description | Shipping Weight lb (kg) |
|-------------|--|-------------------------|
| 10487-X01 | Butt-Swivel Splice Kit | 1 (0.5) |
| 10488-X01 | Junction Swivel Splice Kit | 1 (0.5) |
| 10489-X01 | Vertical Swivel Splice Kit | 1 (0.5) |
| 16487-X01 | UL Classified Butt Swivel Splice Kit | 1 (0.5) |
| 16488-X01 | UL Classified Junction Swivel Splice Kit | 1 (0.5) |
| 16489-X01 | UL Classified Vertical Swivel Splice Kit | 1 (0.5) |

X=color over zinc: 0=Gold, 7=Black

Cable Runway Wall To Rack Kit

The CPI Cable Runway Wall To Rack Kit is a one part number solution to the problem of providing support for cable between the rack and the wall. Kit includes:

- (1) 4' 6" L/54" (1370 mm) Universal Cable Runway; (1) Wall angle support bracket; (1) Rack to runway mounting plate; (1) Pair of end caps; (6) J-bolts

Note: The kit is available with runway that is 6", 9" or 12"W (150 mm, 230 mm or 300 mm). Rack is not included.

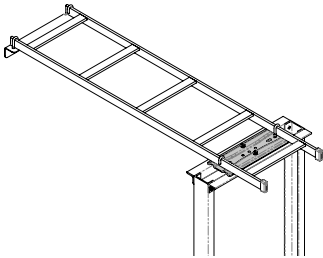

Rack Not Included

| Part Number | Description | Shipping Weight lb (kg) |
|--|--|-------------------------|
| Standard/Universal Racks with 3"D (80 mm) Mounting Channels Width - in (mm) | | |
| 11911-X06 | 6 (150) Cable Runway Wall to Rack Kit | 24 (10.9) |
| 11911-X09 | 9 (230) Cable Runway Wall to Rack Kit | 28 (12.7) |
| 11911-X12 | 12 (300) Cable Runway Wall to Rack Kit | 32 (14.5) |
| Standard Rack with 6"D (150 mm) Mounting Channels Width - in (mm) | | |
| 31473-X06 | 6 (150) Cable Runway Wall to Rack Kit | 17 (7.7) |
| 31473-X09 | 9 (230) Cable Runway Wall to Rack Kit | 19 (8.6) |
| 31473-X12 | 12 (300) Cable Runway Wall to Rack Kit | 24 (10.9) |

X=color: 1=Gray, 2=Computer Beige, 7=Black, E=Glacier White. Gold and Glacier White kits have gold colored hardware. Gray and Black kits have black colored hardware.

3" (80 mm) Channel Rack-To-Runway Mounting Plate

Secures Cable Runway to the top of Standard and Universal Racks. Mounts either parallel or perpendicular to the rack. For proper attachment of 6" W (150 mm) Cable Runway, specify a rack with top bars instead of top angles.

- Installation Best Practices include Runway Elevation Kit (P/N 10506-XXX)

P/N 10595-XXX consists of:

- (1) mounting plate; (4) 5/16-18 x 2 1/4" J-bolts ; (4) 5/16-18 hex nuts; (4) 5/16 split lock washers

P/N 12408-X24 consists of:

- (1) mounting plate; (2) 5/16-18 x 3 1/4" J-bolts; (2) 5/16-18 x 2 1/4" J-bolts; (4) 5/16-18 hex nuts; (4) 5/16 split lock washers

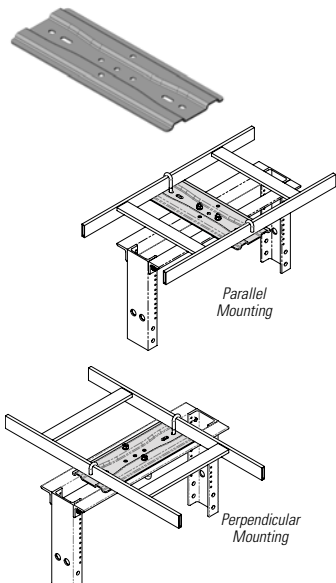

| Part Number | Runway Width in (mm) | Plate Material | Shipping Weight lb (kg) |
|-------------|-----------------------|----------------|-------------------------|
| 10595-X04 | 4 (100) | Steel | 4 (1.8) |
| 10595-X08 | 5 to 8 (130 to 200) | Steel | 5 (2.3) |
| 10595-X12 | 9 to 12 (230 to 300) | Steel | 5 (2.3) |
| 10595-X18 | 15 to 18 (380 to 460) | Steel | 7 (3.2) |
| 12408-X24 | 20 to 24 (510 to 610) | Aluminum | 4 (1.8) |

X=color (10595): 0=Gold, 1=Gray, 2=Computer Beige, 7=Black, E=Glacier White. X=color (10408): 1=Gray, 2=Computer Beige, 5=Clear, 7=Black, E=Glacier White. Gold and Glacier White kits have gold colored hardware. Gray and Black kits have black colored hardware.

3" (80 mm) Channel Rack-To-Runway Mounting Plate With Bracket

Secures Runway to the top of Universal Rack without intruding into mounting space. The combination of the plate and hat-shaped bracket form a clamp around the rack's top angles or top bars. Mounts parallel or perpendicular to the rack. For proper attachment of 6" runway, use top bars (13045 Series) rather than top angles. Installation Best Practices include Runway Elevation Kit (P/N 10506)

Kit includes:

- (1) mounting plate; (2) hat-shaped brackets; (2) J-Bolts, 5/16-18 x 2-1/4"; (3) hex nuts, 5/16-18; (3) split lock washers, 5/16"

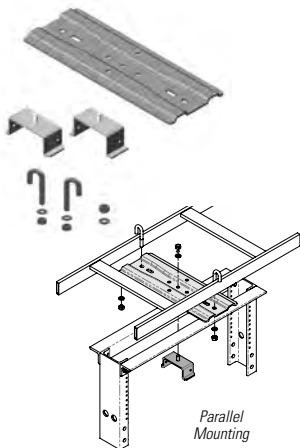

| Part Number | Runway Width in (mm) | Plate Material | Shipping Weight lb (kg) |
|-------------|-----------------------|----------------|-------------------------|
| 12730-X04 | 4 (100) | Steel | 4 (1.8) |
| 12730-X08 | 5 to 8 (130 to 200) | Steel | 5 (2.3) |
| 12730-X12 | 9 to 12 (230 to 300) | Steel | 5 (2.3) |
| 12730-X18 | 15 to 18 (380 to 460) | Steel | 7 (3.2) |
| 13730-X24 | 20 to 24 (510 to 610) | Aluminum | 4 (1.8) |

X=color (12730): 1=Gray, 2=Computer Beige, 7=Black, E=Glacier White. X=color (13730): 1=Gray, 2=Computer Beige, 5=Clear, 7=Black, E=Glacier White. Gold and Glacier White kits have gold colored hardware. Other kits have black colored hardware.

6" (150 mm) Channel Rack-To-Runway Mounting Plate

Secures Cable Runway to the top of 6"D (150 mm) Standard Rack. Mounts either parallel or perpendicular to runway.

- Installation Best Practices include Runway Elevation Kit (P/N 10506-XXX)

P/N 12121-XXX consists of:

- (1) mounting plate
- (4) 5/16-18 x 2 1/4" J-bolts
- (4) 5/16-18 hex nuts
- (4) 5/16 split lock washers

P/N 12409-X24 consists of:

- (1) mounting plate
- (2) 5/16-18 x 3 1/4" J-bolts
- (2) 5/16-18 x 2 1/4" J-bolts
- (4) 5/16-18 hex nuts
- (4) 5/16 split lock washers

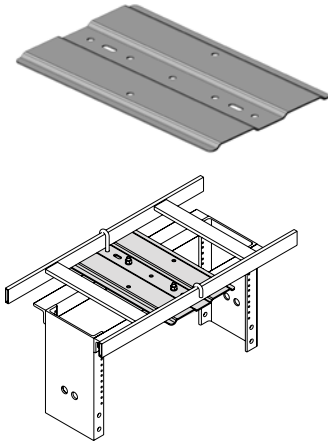

| Part Number | Runway Width in (mm) | Plate Material | Shipping Weight lb (kg) |
|-------------|-----------------------|----------------|-------------------------|
| 12121-X09 | 5 to 9 (130 to 230) | Steel | 5 (2.3) |
| 12121-X12 | 9 to 12 (230 to 300) | Steel | 5 (2.3) |
| 12121-X18 | 15 to 18 (380 to 460) | Steel | 7 (3.2) |
| 12409-X24 | 20 to 24 (510 to 610) | Aluminum | 5 (2.3) |

*X=*color (12121): 1=Gray, 2=Computer Beige, 7=Black, E=Glacier White. *X=*color (12409): 1=Gray, 2=Computer Beige, 5=Clear, 7=Black, E=Glacier White. Gold and Glacier White kits have gold colored hardware. Gray and Black kits have black colored hardware. 12409-X24 adds 1.25" (32 mm) to height of rack.

6" (150 mm) Channel Rack-To-Runway Mounting Plate With Bracket

Secures Cable Runway to the top of 6"D (150 mm) Standard Rack without intruding into valuable mounting space. The combination of the flat plate and hat-shaped bracket form a clamp around the rack's top angles or top bars. Mounts either parallel or perpendicular to the runway.

- Installation Best Practices include Runway Elevation Kit (P/N 10506-XXX)

Kit includes:

- (1) mounting plates
- (2) hat-shaped bracket
- (2) J-Bolts, 5/16-18 x 2-1/4"
- (3) hex nuts, 5/16-18
- (3) split lock washers, 5/16"

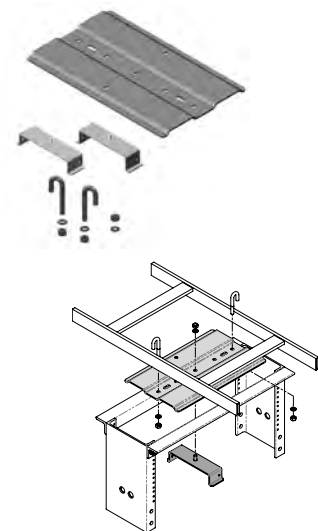

| Part Number | Runway Width in (mm) | Plate Material | Shipping Weight lb (kg) |
|-------------|-----------------------|----------------|-------------------------|
| 12731-X09 | 5 to 9 (130 to 230) | Steel | 5 (2.3) |
| 12731-X12 | 9 to 12 (230 to 300) | Steel | 5 (2.3) |
| 12731-X18 | 15 to 18 (380 to 460) | Steel | 7 (3.2) |
| 13731-X24 | 20 to 24 (510 to 610) | Aluminum | 5 (2.3) |

*X=*color (12731): 1=Gray, 2=Computer Beige, 7=Black, E=Glacier White. *X=*color (13731): 1=Gray, 2=Computer Beige, 5=Clear, 7=Black, E=Glacier White. Gold and Glacier White kits have gold colored hardware. Gray and Black kits have black colored hardware. 13731-X24 adds 1.25" (32 mm) to height of rack.

Cable Runway Elevation Kit for Racks, TeraFrame, GlobalFrame and MegaFrame Cabinets

Supports Cable Runway above a continuous row of CPI Racks or TeraFrame, GlobalFrame or MegaFrame Cabinets of varying heights and provides additional space between the tops of the racks or cabinets and the cable runway, which can create smoother transition of cables.

- Three ranges of incremental elevation
- Can be mounted perpendicular or parallel
- Rack kit includes a single pair of brackets and assembly hardware
- Rack kits attach to the top of the rack with a Rack-To-Runway Mounting Plate (P/N 10595 or 12121, sold separately)
- Cabinet kits include two pairs of brackets and assembly hardware
- Cabinet kits attach directly to the top of the TeraFrame, GlobalFrame or MegaFrame Cabinets
- Compatible with Adjustable Cable Runway

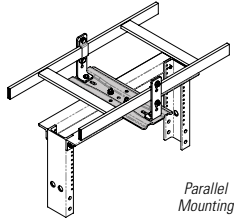

Parallel Mounting

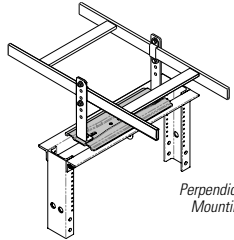

Perpendicular Mounting

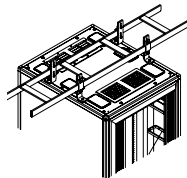

Cabinet Mounting

| Rack | Shipping Weight lb (kg) | Cabinet | Shipping Weight lb (kg) |
|--|-------------------------|-----------|-------------------------|
| 2", 2.5" or 3"H (50 mm, 64 mm or 80 mm) Elevation | | | |
| 10506-X02 | 2 (0.9) | 10506-X12 | 2 (0.9) |
| 4", 5" or 6"H (100 mm, 130 mm or 150 mm) Elevation | | | |
| 10506-X06 | 3 (1.4) | 10506-X16 | 5 (2.3) |
| 10", 11" or 12"H (250 mm, 280 mm or 300 mm) Elevation | | | |
| 10506-X08 | 2 (0.9) | 10506-X18 | 4 (1.8) |

*X=*color: 0=Gold, 1=Gray, 2=Computer Beige, 7=Black, E=Glacier White. Gold and Glacier White kits have gold colored hardware. Gray and Black kits have black colored hardware.

Cable Pathway Elevation Kits for ZetaFrame™ Cabinet

Supports CPI Cable Runway or Pemsal® Rejiband® Wire Mesh Cable Tray above a continuous row of ZetaFrame Cabinets, providing additional space between the tops of the cabinets and the cable runway and trays.

- Three ranges of incremental elevation.
- Two Tier version supports two levels of cable runway or wire mesh cable tray
- Recommended pathway support span is 5' (1.5 m).
- Attaches to top track of ZetaFrame Cabinet frame. Position pathway front-to-rear on track
- Kit includes (1) pair of elevation brackets, all hardware to attach the brackets to the ZetaFrame Cabinet, and all required hardware to attach Cable Runway to elevation brackets.
- Use Part Clamp (P/N 64010060-050; ordered separately) to attach Pemsal Rejiband Wire Mesh Cable Tray

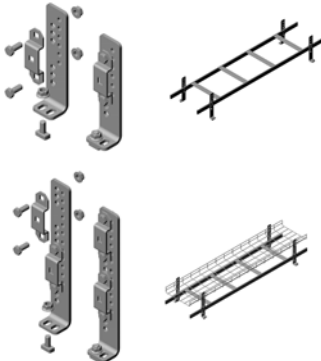

| Part Number | | Description Height in (mm) | Shipping Weight lb (kg) |
|-------------|-----------|--------------------------------|-------------------------|
| 1 Tier | 2 Tier | | |
| 60508-X02 | 60508-X22 | 2", 2.5", 3"H (50, 64, 75) | 3.1 (1.5) |
| 60508-X06 | 60508-X26 | 4", 5", 6"H (100, 127, 150) | 3.8 (18) |
| 60508-X08 | N/A | 10", 11", 12"H (250, 280, 300) | 5.5 (2.5) |

*Note: X=*color: 7=Black, E=Glacier White. Shipping weight is for 1 Tier Elevation Kit

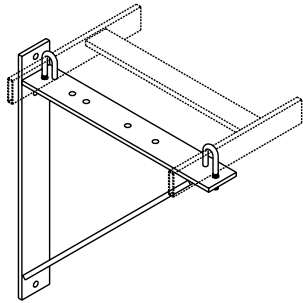

Triangular Support Bracket, Aluminum

Triangular Support Bracket provides wall support for Cable Runway. Made of 1/4" x 2" (6.4 mm x 50 mm) aluminum bar. Load rating is 100 lb (45.4 kg).

- Compatible with Adjustable Cable Runway

Kit includes:

- (1) triangular bracket; (2) 5/16-18 x 2 1/4" J-bolts ; (2) 5/16-18 hex nuts & 5/16 lock washers

| Part Number | Runway Widths in (mm) | Shipping Weight lb (kg) |
|-------------|-----------------------|-------------------------|
| 11312-X06 | 4-6 (100 - 150) | 2 (0.9) |
| 11312-X12 | 6-12 (150 - 300) | 3 (1.4) |
| 11312-X18 | 12-18 (300 - 460) | 3 (1.4) |

X=color: 1=Gray, 2=Computer Beige, 7=Black, E=Glacier White.

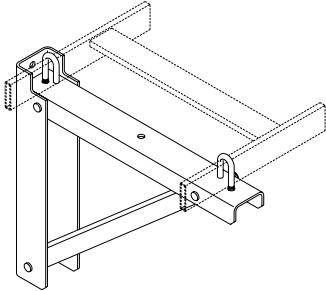

Triangular Support Bracket, Steel

Triangular Support Bracket provides wall support for cable runway. Made of cold-rolled steel. Load rating is 400 lb (181.4 kg).

- Compatible with Adjustable Cable Runway

Kit includes:

- (1) vertical wall-mounting bracket; (1) runway support channel ; (1) angle support channel; (3) clevis pins (5/16" diameter) & cotter pins; (2) 5/16-18 x 2 1/4" J-bolts; (2) 5/16-18 hex nuts & 5/16 lock washers

| Part Number | Runway Widths in (mm) | Shipping Weight lb (kg) |
|-------------|-----------------------|-------------------------|
| 11746-X12 | 4-12 (100-300) | 5 (2.3) |
| 11746-X18 | 9-18 (230-460) | 8 (3.6) |
| 11746-X24 | 9-24 (230-610) | 9 (4.1) |

X=color: 0=Gold, 1=Gray, 2=Computer Beige, 7=Black, E=Glacier White. Gold and Glacier White kits have gold colored hardware. Gray and Black kits have black colored hardware.

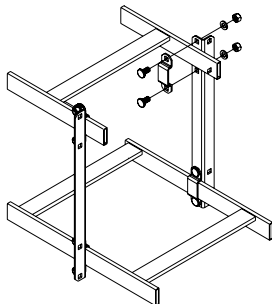

Cable Runway Standoff Support Kit

Allows the attachment of cable runway 12" (300 mm) directly above and either parallel or perpendicular to existing Cable Runway. Each kit consists of the following items: two steel angle pieces, four steel brackets and eight sets of nuts, bolts and washers. The angle pieces are available in Gray, Computer Beige, Black or Gold finish.

- Compatible with Adjustable Cable Runway

| Part Number | Description | Shipping Weight lb (kg) |
|-------------|----------------------|-------------------------|
| 31470-X12 | Standoff Support Kit | 1 (0.5) |

X=color: 0=Gold, 1=Gray, 2=Computer Beige, 7=Black, E=Glacier White. Gold, Glacier White and Computer Beige kits have gold-colored hardware. Gray and Black kits have black color hardware.

Wall Angle Support Kit, Cable Runway

2" x 2" x .105" (50 mm x 50 mm x 2.67 mm) steel support angle is designed for wall-mounting specific widths of Cable Runway.

- Compatible with Adjustable Cable Runway

Kit includes:

- (1) wall angle; (2) 5/16-18 x 2 1/4" J-bolts ; (2) 5/16-18 hex nuts; (2) 5/16 lock washers

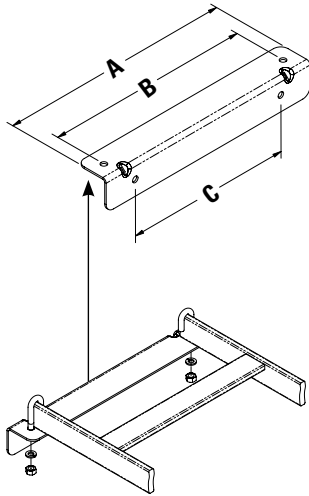

| Part Number | Runway Width in (mm) | Dim. A in (mm) | Dim. B in (mm) | Dim. C in (mm) |
|-------------|----------------------|----------------|----------------|----------------|
| 11421-X04 | 4 (100) | 6 (150) | 4.31 (109.5) | 4.31 (109.5) |
| 11421-X06 | 6 (150) | 8 (200) | 6.31 (160.3) | 4 (100.0) |
| 11421-X09 | 9 (230) | 11 (280) | 9.31 (236.5) | 7 (180.0) |
| 11421-X10 | 10 (250) | 12 (300) | 10.21 (261.9) | 8 (200.0) |
| 11421-X12 | 12 (300) | 14 (360) | 12.31 (312.7) | 10 (250.0) |
| 11421-X15 | 15 (380) | 17 (430) | 15.31 (388.9) | 13 (330.0) |
| 11421-X18 | 18 (460) | 20 (510) | 18.31 (465.1) | 16 (410.0) |
| 11421-X20 | 20 (510) | 22 (560) | 20.31 (515.9) | 18 (460.0) |
| 11421-X24 | 24 (610) | 26 (660) | 24.31 (617.5) | 22 (460.0) |
| 11421-X30 | 30 (760) | 32 (810) | 30.31 (769.9) | 28 (710.0) |

*X=*color: 0=Gold, 1=Gray, 2=Computer Beige, 7=Black, E=Glacier White. Gold and Glacier White kits have gold colored hardware. Gray and Black kits have black colored hardware.

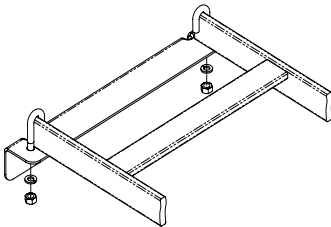

J-Bolt Kit, Cable Runway

To attach Cable Runway to Wall Angle Support, a Wall Support Bracket or to a MegaFrame® Cabinet.

- Compatible with Adjustable Cable Runway

Kit (wall angle/support) consists of:

- (2) 5/16-18 x 2-1/4" J-bolts (11431-001)
- (2) 5/16-18 hex nuts
- (2) 5/16 split lock washers

MegaFrame Kit includes:

- (4) 5/16-18 x 3-1/4" J-bolts
- (4) 5/16" split lock washers
- (4) 5/16-18 hex nuts



| Part Number | Description | Shipping Weight lb (kg) |
|-------------|-----------------------|-------------------------|
| 11308-X01 | J-Bolt Kit | 1 (0.5) |
| 11308-X05 | J-Bolt Kit, MegaFrame | 1 (0.5) |

*X=*color: 0=Gold, 7=Black

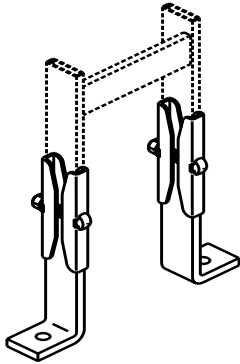

Foot Kit, Cable Runway

To attach and secure Cable Runway to a wall or floor. Foot made of 3/8" x 1-1/2" x 6"H (9.53 mm x 38 mm x 150 mm) steel.

- Compatible with Adjustable Cable Runway

Kit includes:

- (2) cable rack feet
- (4) splice plates
- (2) 3/8-16 x 2 1/4" trimmed round head square neck bolts
- (2) 3/8-16 hex nuts
- (2) 3/8" lock washers

| Part Number | Description | Shipping Weight lb (kg) |
|-------------|-------------|-------------------------|
| 11309-X01 | Foot Kit | 4 (1.8) |

X=color: 0=Gold, 1=Gray, 2=Computer Beige, 7=Black, E=Glacier White. Gold and Glacier White kits have gold colored hardware. Gray and Black kits have black colored hardware.

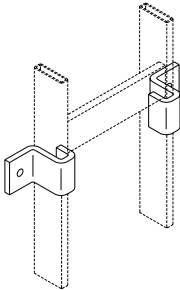

Vertical Wall Brackets

Used to secure Cable Runway with 1-1/2" x 3/8" (38 mm x 9.53 mm) stringers to a wall. Sold in pairs.

- Compatible with Adjustable Cable Runway
- Material is 1/4" x 1-1/2" (6.4 mm x 33 mm) steel
- Gold color over zinc plating or painted
- Wall mounting hardware not included

| Part Number | Description in (mm) | Shipping Weight lb (kg) |
|-------------|-----------------------------------|-------------------------|
| 10608-X01 | Runway Wall Brackets (Pair), Gold | 1 (0.5) |

X=color: 0=Gold, 7=Black, E=Glacier White.

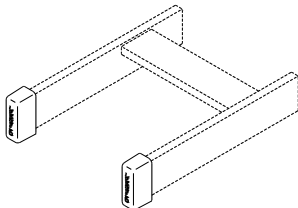

Protective End Caps For Runway

Covers and protects exposed ends of cable runway and auxiliary framing bar and channel. Reduces chances of personal injury and equipment damage.

- Made of fire-retardant flat black colored rubberized material
- Sold in pairs
- Only P/N 10642-001 is compatible with Adjustable Cable Runway

| Part Number | Description in (mm) | Shipping Weight lb (kg) |
|-------------|---------------------------------------|-------------------------|
| 10642-001 | For 1-1/2 x 3/8 (38 x 9.53) Stringer | 1 (0.5) |
| 10757-001 | For 2 x 3/8 (50 x 9.53) Auxiliary Bar | 1 (0.5) |

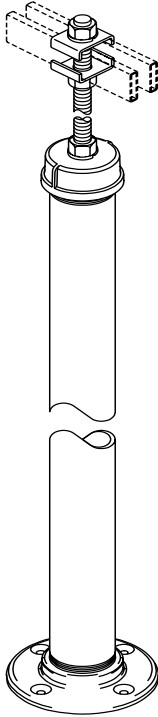

Tall Pipe Stand, Cable Runway

Supports auxiliary framing or Cable Runway from the floor.

- Material is steel
- Compatible with Adjustable Cable Runway

Kit includes:

- (1) floor flange
- (1) appropriate length of 2" (50 mm) pipe
- (1) pipe cap, center drilled and tapped for a 5/8- 11 threaded rod (P/N 11440, not included)
- (3) 5/8-11 hex nuts
- (3) 5/8 split lock washers
- (4) 1/4-20 x 1 1/2" studs
- (4) 1/4-20 concrete anchors
- (4) 1/4-20 hex nuts
- (4) 1/4 Type B washers

Installation also requires:

- (1) grid clamp of appropriate width, See P/N 10609
- (1) 5/8-11 threaded rod of appropriate length, See P/N 11440

Note: Must be securely mounted to floor with included anchor kit.

Also, in the case of attachment to Cable Runway, you may need to use Runway Support Brackets, series 11408 or 10607.

| Part Number | Description in (mm) | Overall Height ft (m) | Shipping Weight lb (kg) |
|-------------|----------------------------------|-----------------------|-------------------------|
| 10684-X01 | 2 x 79 (50 x 2010) Tall Pole | 7 (2.1) | 16 (7.3) |
| 10684-X02 | 2 x 85 (50 x 2160) Tall Pole | 7.6 (2.3) | 18 (8.2) |
| 10684-X03 | 2 x 91 (50 x 2310) Tall Pole | 8 (2.4) | 20 (9.1) |
| 10684-X04 | 2 x 103 (50 x 2620) Tall Pole | 9 (2.7) | 24 (10.9) |

X=color: 1=Gray, 2=Computer Beige, 7=Black, Glacier White.

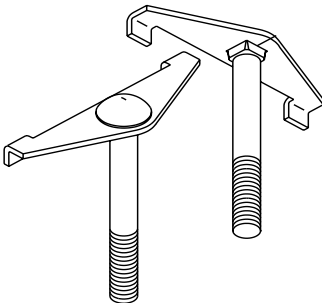

Spanner Kit, Auxiliary Framing Channel/Cable Runway

Used to attach Cable Runway to auxiliary framing.

- Gold over zinc plating, sold individually
- Compatible with Adjustable Cable Runway

Kit includes:

- (1) Spanner Bolt; (1) 1/2-13 split lock washer; (1) 1/2-13 hex nut

| Part Number | Description Nominal Size and Length | Shipping Weight lb (kg) |
|-------------|-------------------------------------|-------------------------|
| 10702-001 | 1/2-13 x 4-3/8" | 1 (0.5) |
| 10702-002 | 1/2-13 x 4-7/8" | 1 (0.5) |

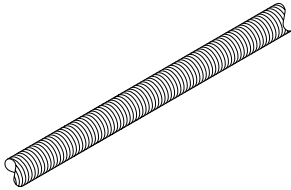

Threaded Drop Rods

Used to support Cable Runway from ceilings.

- Standard threads, various lengths
- Gold chem film over zinc plate finish

| Part Number | Description | Shipping Weight lb (kg) |
|-------------|--------------------------|-------------------------|
| 11440-001 | 3/8-16 UNC-2A rod, 6'L | 2 (0.9) |
| 11440-002 | 5/8-11 UNC-2A rod, 6'L | 5 (2.3) |
| 11440-003 | 3/8-16 UNC-2A rod, 12'L | 5 (2.3) |
| 11440-004 | 5/8-11 UNC-2A rod, 12'L | 10 (4.5) |
| 11440-005 | 5/8-11 UNC-2A rod, 8'L | 7 (3.2) |
| 11440-006 | 5/8-11 UNC-2A rod, 4'L | 4 (1.8) |
| 11440-007 | 5/8-11 UNC-2A rod, 6"L | 1 (0.5) |
| 11440-008 | 5/8-11 UNC-2A rod, 8"L | 1 (0.5) |
| 11440-009 | 5/8-11 UNC-2A rod, 5.5"L | 1 (0.5) |
| 11440-012 | 5/8-11 UNC-2A rod, 1'L | 1 (0.5) |
| 11440-024 | 5/8-11 UNC-2A rod, 2'L | 2 (0.9) |
| 11440-036 | 5/8-11 UNC-2A rod, 3'L | 3 (1.4) |

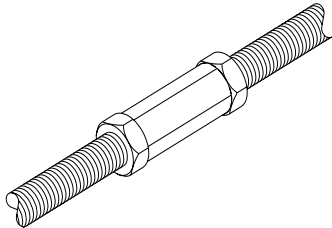

Threaded Rod Coupling Kit

Used to splice two threaded rods end to end.

| Part Number | Description | Shipping Weight lb (kg) |
|-------------|--------------|-------------------------|
| 10697-001 | For 3/8" Rod | 3 (1.4) |
| 10697-002 | For 5/8" Rod | 3 (1.4) |

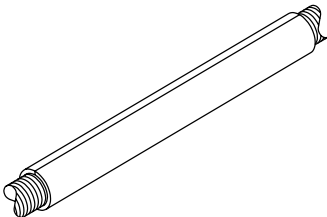

Threaded Rod Cover

Protects cable from damage during installation.

- Made of plastic PVC tubing. Gray I.D. = 0.630" (16 mm)

| Part Number | Description | Shipping Weight lb (kg) |
|-------------|----------------------------|-------------------------|
| 11085-001 | Threaded Rod Cover, 10 (3) | 5 (2.3) |

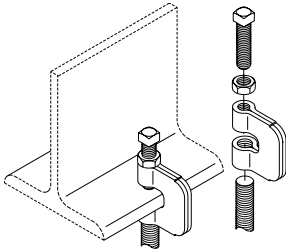

Threaded Rod I-Beam Clamps, Cable Runway

Fastens a 3/8" or 5/8" threaded rod to an I-beam.

- Material is cold-rolled steel
- Finish is gold over zinc plating

| Part Number | Description | Shipping Weight lb (kg) |
|-------------|--------------------------|-------------------------|
| 10557-001 | For 3/8"-16 Threaded Rod | 3 (1.4) |
| 10557-003 | For 5/8"-11 Threaded Rod | 3 (1.4) |

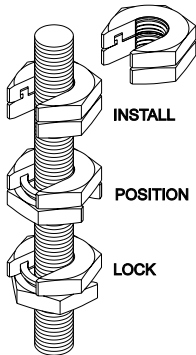

Slip-On® Lock Nut

Used to add a nut to threaded rod without having to thread from the end. Zinc plated. Slip-On® is a registered trademark of Slip-On Lock Nut Co.

| Part Number | Description | Shipping Weight lb (kg) |
|--------------|----------------------------|--------------------------------------|
| 03003-001 | 3/8"-16 Slip-On Lock Nut | 1 (0.5) |
| 03003-002 | 5/8"-11 Slip-On Lock Nut | 1 (0.5) |
| Size in (mm) | Recommended Load - lb (kg) | Recommended Torque |
| 3/8 (10) | 2,000 (907.2) | 19-25 ft/lb (26 Nm-34 Nm) |
| 5/8 (16) | 5,000 (2268.0) | 100-120 ft/lb (135.6 Nm-162.7 Nm) |

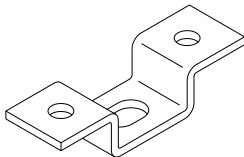

Ceiling Support Bracket

Used to attach threaded rod to ceiling. Hardware is not included.

- Compatible with Adjustable Cable Runway

| Part Number | Description | Shipping Weight lb (kg) |
|-------------|-------------------------|-------------------------|
| 11406-001 | 3/8" (10 mm) or M10 Rod | 1 (0.5) |
| 11406-002 | 5/8" (16 mm) or M16 Rod | 1 (0.5) |

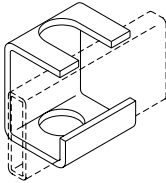

Slotted Support Bracket

Secures threaded rod to Cable Runway.

- Compatible with Adjustable Cable Runway

Kit includes:

- (1) slotted support bracket
- (2) hex nuts
- (2) split lock washers

| Part Number | Description in (mm) | Shipping Weight lb (kg) |
|-------------|---|-------------------------|
| 10607-002 | For 3/8" or M10 Rod and 1-1/2" (38) Stringers | 1 (0.5) |
| 10607-001 | For 5/8" or M16 Rod and 1-1/2" (38) Stringers | 1 (0.5) |

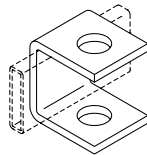

Runway Support Brackets

Used to attach threaded rod to ceiling. Hardware is not included.

- Compatible with Adjustable Cable Runway

| Part Number | Description | Shipping Weight lb (kg) |
|-------------|---|-------------------------|
| 11408-001 | For 3/8" (10 mm) or M10 Rod and 1-1/2" (38) Stringers | 1 (0.5) |
| 11408-003 | For 5/8" (16 mm) or M16 Rod and 1-1/2" (38) Stringers | 1 (0.5) |

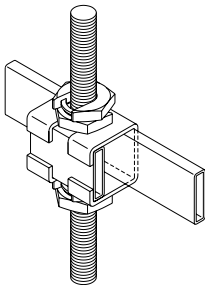

Slip-On® Support Bracket, Cable Runway

Provides easy additions of Cable Runway layers to existing cable racks by allowing support brackets and nuts to slip over drop rod.

- For use with 5/8" (16 mm) threaded rod only
- Finish is gold over zinc plating
- Compatible with Adjustable Cable Runway

Kit includes:

- (2) patented Slip-On nut
- (1) slotted bracket
- (1) retainer piece

| Part Number | Description | Shipping Weight lb (kg) |
|-------------|-------------------------|-------------------------|
| 10873-001 | Slip-on Support Bracket | 1 (0.5) |

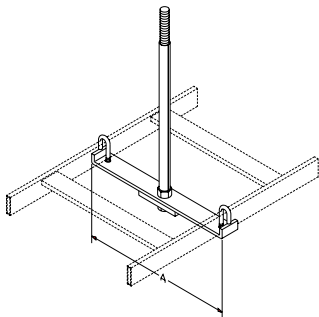

The Cable Runway Center Support Kit is available in sizes to support 6" to 24" W (150 mm to 610 mm) cable runway. Not included: Threaded Rod (P/N 11440-00X) and Ceiling Support Bracket (P/N 11406-002).

Cable Runway Center Support Kit

This kit has been designed to make installation of cable runway in the ceiling even easier by using just a single point of attachment. The center attachment design not only makes installation easy, but also provides quick and simple cable routing with no need to thread the cable between the runway supports. The support kit securely attaches to the cable runway stringer, eliminating possible dislocations.

- Made of steel
- Provides an "open" support system with quick and simple cable routing
- Threaded rod cover protects cable insulation from damage
- Compatible with Adjustable Cable Runway

Kit includes:

- (1) support bracket; (1) reinforcement bar; (2) 5/8-11 hex nuts; (1) 5/8 split lock washers; (1) 12" L (300 mm) threaded rod cover; (1) J-bolt kit (2 J-bolts; 2 nuts; 2 washers)

| Part Number | Description Width - in (mm) | Dim. A in (mm) | Shipping Weight lb (kg) |
|-------------|-----------------------------|----------------|-------------------------|
| 12362-X06 | 6 (150) | 6.56 (166.6) | 2 (0.9) |
| 12362-X12 | 12 (300) | 12.56 (319.0) | 2 (0.9) |
| 12362-X15 | 15 (380) | 16.20 (411.5) | 3 (1.4) |
| 12362-X18 | 18 (460) | 19.20 (487.7) | 4 (1.8) |
| 12362-X24 | 24 (610) | 25.20 (640.1) | 5 (2.3) |

X=color: 0=Gold, 1=Gray, 2=Computer Beige, 7=Black, E=Glacier White. Gold and Glacier White kits have gold colored hardware. Gray and Black kits have black colored hardware.

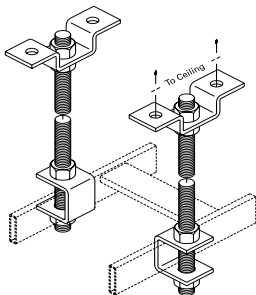

Drawing shows 2 kits

Note: Recommended spacing between ceiling kits is 5' (1.5 m). The ceiling hole diameter for P/N 11310 is .375" (9.5 mm) for 3/8" or M10 rod; .500" (12.7 mm) for 5/8" or M16 rod.

Threaded Ceiling Kit, Cable Runway

Used to suspend Cable Runway from the ceiling. Material is steel, finished with gold over zinc plating.

- Compatible with Adjustable Cable Runway

Kit includes:

- (1) ceiling support bracket
- (1) either 3/8-16 x 6', 5/8-11 x 6', M10 x 2M or M16 x 2M threaded rod
- (1) runway support bracket
- (4) either 3/8-16, 5/8-11, M10 or M16 hex nuts

| Part Number | Description | Shipping Weight lb (kg) |
|-------------|--------------------------------|-------------------------|
| 11310-001 | Threaded Ceiling Kit, 3/8" Rod | 3 (1.4) |
| 11310-003 | Threaded Ceiling Kit, 5/8" Rod | 7 (3.2) |
| 11310-093 | Threaded Ceiling Kit, M10 x 2M | 7 (3.2) |
| 11310-094 | Threaded Ceiling Kit, M16 x 2M | 7 (3.2) |

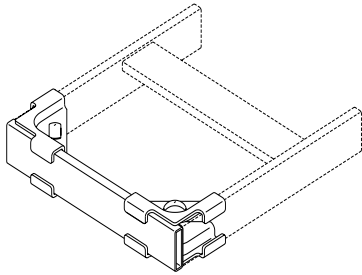

Gold, Computer Beige and Glacier White kits include gold colored hardware. Gray and Black kits include black colored hardware.

End Closing Kit, Cable Runway

Used to close an unspliced end of Cable Runway. Made of 3/8" x 1-1/2" x .065" (9.53 mm x 38 mm x 1.65 mm) thick rectangular steel tubing.

Kit includes:

- Compatible with Adjustable Cable Runway
- (1) end closing bar
- (4) corner clamp plates
- (2) 3/8-16 x 1 3/8" trimmed round head square neck bolts
- (2) 3/8-16 hex nuts

| Part Number | Description | Shipping Weight lb (kg) |
|-------------|-------------------------------|-------------------------|
| 11700-X04 | End Closing Kit, Cable Runway | 4 (100) |
| 11700-X05 | End Closing Kit, Cable Runway | 5 (130) |
| 11700-X06 | End Closing Kit, Cable Runway | 6 (150) |
| 11700-X09 | End Closing Kit, Cable Runway | 9 (230) |
| 11700-X12 | End Closing Kit, Cable Runway | 12 (300) |
| 11700-X15 | End Closing Kit, Cable Runway | 15 (380) |
| 11700-X18 | End Closing Kit, Cable Runway | 18 (460) |
| 11700-X20 | End Closing Kit, Cable Runway | 20 (510) |
| 11700-X24 | End Closing Kit, Cable Runway | 24 (610) |

X=color: 0=Gold, 1=Gray, 2=Computer Beige, 7=Black, E=Glacier White. Gold, Computer Beige and Glacier White kits have gold colored hardware. Gray and Black kits have black colored hardware.

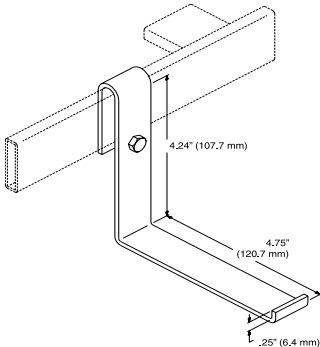

"L" Bracket, Cable Runway

Bracket provides a separate facility for running power conductors or other cables that should be physically separated from main cables.

- Made of 1/8" x 1" (3.18 mm x 30 mm) steel; gold finish/color over zinc plating
- Compatible with Adjustable Cable Runway

Kit includes (1 each):

- Bracket for 1-1/2" stringer; 1/4-20 x 3/4" hex bolt

| Part Number | Description | Shipping Weight lb (kg) |
|-------------|-------------|-------------------------|
| 11268-001 | "L" Bracket | 1 (0.5) |

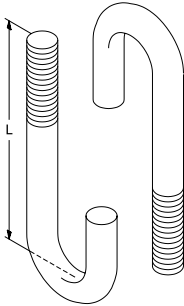

J-Bolts (Hook Bolt, Round Bend), Auxiliary Framing Channel/Cable

Used to bolt Cable Runway (11431 series only), auxiliary framing channels and/or bars together.

- Gold over zinc and black zinc plate finish
- Includes nut and split lock washer
- Commercial grade, kits sold individually
- Only P/N Series 11431-XXX is compatible with Adjustable Cable Runway

| Part Number | Nominal Size | Length | Opening | Shipping Weight lb (kg) |
|-------------|--------------|--------|---------|-------------------------|
| 11430-X01 | 1/4-20 | 1 3/4" | 7/32 | 1 (0.5) |
| 11430-X02 | 1/4-20 | 2" | 7/32 | 1 (0.5) |
| 11431-X01 | 5/16-18 | 2 1/4" | 7/16 | 1 (0.5) |
| 11431-X02 | 5/16-18 | 2 3/4" | 7/16 | 1 (0.5) |
| 11431-X03 | 5/16-18 | 3 1/4" | 7/16 | 1 (0.5) |
| 11431-X04 | 5/16-18 | 3 3/4" | 9/32 | 1 (0.5) |

X=color: 0=Gold, 7=Black



12 oz (340 g)
pressurized can

Touch-Up Paint In Spray Can

Air dry lacquer for touching up finish. Matches color and gloss of CPI's textured paint; air dries to hard finish in minutes.

- Compatible with Adjustable Cable Runway

| Part Number | Description oz (g) | Shipping Weight lb (kg) |
|-------------|--------------------|-------------------------|
| 25400-X00 | 12 (340) Spray Can | 2 (0.9) |

X=color: 1=Gray, 2=Computer Beige, 7=Black, E=Glacier White.



1 oz (30 g) bottle
with applicator

Touch-Up Paint In Bottle

Air dry waterborne paint for touching up finish. Matches color and gloss of CPI's textured paint.

- Compatible with Adjustable Cable Runway

| Part Number | Description oz (g) | Shipping Weight lb (kg) |
|-------------|--------------------|-------------------------|
| 25401-X00 | 1 (30) Bottle | 2 (0.9) |

X=color: 1=Gray, 2=Computer Beige, 7=Black, E=Glacier White.

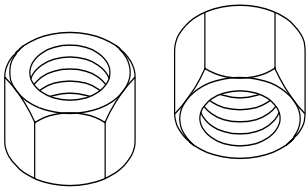

Hex Nuts

- Zinc plate or gold chem (yellow zinc plate) finish
- Sold in packs of 100

| Part Number Pack of 100 | Nominal Size | Finish | Shipping Weight lb (kg) |
|----------------------------|--------------|-------------|----------------------------|
| 20142-171 | 1/4-20 | Gold | 1 (0.5) |
| 20017-171 | 1/4-20 | Zinc Plated | 1 (0.5) |
| 20142-181 | 5/16-18 | Gold | 1 (0.5) |
| 20017-181 | 5/16-18 | Zinc Plated | 1 (0.5) |
| 20142-191 | 3/8-16 | Gold | 2 (0.9) |
| 20017-191 | 3/8-16 | Zinc Plated | 2 (0.9) |
| 03001-101 | 1/2-13 | Gold | 4 (1.7) |
| 20142-121 | 5/8-11 | Gold | 7 (3.3) |

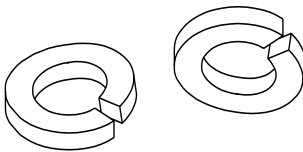

Split Lock Washers

- Zinc plate or gold chem (yellow zinc plate) finish
- Sold in packs of 100

| Part Number Pack of 100 | Nominal Size | Finish | Shipping Weight lb (kg) |
|----------------------------|--------------|-------------|----------------------------|
| 04003-102 | 1/4" | Gold | 1 (0.5) |
| 20015-170 | 1/4" | Zinc Plated | 1 (0.5) |
| 20141-180 | 5/16" | Gold | 1 (0.5) |
| 20015-180 | 5/16" | Zinc Plated | 1 (0.5) |
| 20141-190 | 3/8" | Gold | 1 (0.5) |
| 20015-190 | 3/8" | Zinc Plated | 1 (0.5) |
| 20141-110 | 1/2" | Gold | 1 (0.5) |
| 04003-101 | 5/8" | Gold | 1 (0.5) |

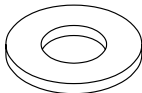

Washers: Type A Plain

- Zinc plate or gold chem (yellow zinc plate) finish
- Sold in packs of 100

| Part Number Pack of 100 | Nominal Size | Finish | Shipping Weight lb (kg) |
|----------------------------|--------------|-------------|----------------------------|
| 20283-112 | 5/16" Wide | Zinc Plated | 1 (0.5) |
| 04002-102 | 3/8" Wide | Gold | 1 (0.5) |
| 20283-113 | 3/8" Narrow | Zinc Plated | 1 (0.5) |
| 04002-101 | 5/8" Wide | Gold | 1 (0.5) |
| 20283-122 | 5/8" Wide | Zinc Plated | 1 (0.5) |

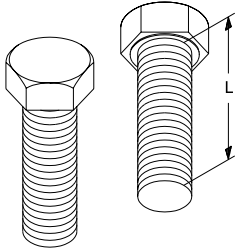

Hex Cap Bolts

Also called Washer Faced Hex Cap Screws.

- Commercial grade
- Zinc plate or gold chem (yellow zinc plate) finish
- Sold in packs (quantities vary)

| Part Number (Pack) | Nominal Size | Length | Finish | Pack Qty | Shipping Weight lb (kg) |
|--------------------|--------------|--------|-------------|----------|-------------------------|
| 20290-116 | 1/4-20 | 3/4" | Zinc Plated | 100 | 2 (0.8) |
| 20290-128 | 1/4-20 | 2-1/4" | Zinc Plated | 100 | 4 (1.8) |
| 20290-226 | 5/16-18 | 2" | Zinc Plated | 100 | 6 (2.5) |
| 20290-317 | 3/8-16 | 7/8" | Zinc Plated | 100 | 5 (2.1) |
| 02004-101 | 3/8-16 | 1-1/4" | Gold | 100 | 6 (2.5) |
| 02004-102 | 1/4-20 | 1-1/4" | Gold | 100 | 3 (1.1) |
| 02004-103 | 1/2-13 | 1-1/2" | Gold | 100 | 12 (5.3) |
| 02004-104 | 3/8-16 | 1-1/2" | Gold | 100 | 6 (2.5) |
| 02004-105 | 1/2-13 | 1-3/4" | Gold | 100 | 13 (5.9) |
| 02004-056 | 5/8-11 | 1-1/4" | Gold | 50 | 9 (3.9) |
| 02004-057 | 5/8-11 | 3-1/4" | Gold | 25 | 8 (3.8) |

Note: Shipping weights are for Pack Quantity. Please note pack quantity column.

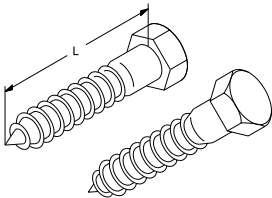

Hex Lag Screw

Used to install racks onto wood or other soft surfaces.

- Gold chem (yellow zinc plate) over zinc plate finish
- Sold in packs (quantities vary)

| Part Number (Pack) | Nominal Size | Length | Pack Qty | Shipping Weight lb (kg) |
|--------------------|--------------|--------|----------|-------------------------|
| 02006-051 | 1/2-6 | 2" | 50 | 6 (2.6) |
| 02006-052 | 5/8-5 | 2" | 50 | 11 (4.8) |
| 02007-104 | 1/4-10 | 2" | 100 | 3 (1.4) |
| 20098-132 | 3/8-7 | 2" | 100 | 7 (3.0) |

Note: Shipping weights are for Pack Quantity. Please note pack quantity column.



PEMSA® Rejiband® Wire Mesh Cable Tray System

Pemsa Rejiband Wire Mesh Tray System is a complete pathway solution that can be supported from the wall, ceiling, floor or from the tops of CPI Rack and Cabinet Systems. A wide range of easy-to-install accessories available to complete your cabling installation needs.

Features and Benefits:

- Flexible pathway—Tray can be cut and formed into turns and transitions using standard splices, simplifying design and components selection.
- Fast installation—A range of fast-connecting splices and supports speed assembly and installation.
- Electrical continuity—Zinc plating and BLACK C8® finishes allow bonding through splice connections for electrical continuity.
- High corrosion resistance—The BLACK C8® finish meets resistance class EN 61537 Class C8, delivering corrosion resistance superior to hot-dipped galvanized and approaching the level of stainless steel.
- Wide range of accessories—Allows quick interface with electrical fittings and superior support when transitioning network cables.
- Increased safety—Rounded safety edge on the tops of all vertical wires protects installers and cables from cuts.



For additional Pemsa products and details, please go to: chatsworth.com/pemsa or refer to the CPI-PEMSA Catalog for complete product line.

PEMSA® Rejiband® Wire Mesh Cable Tray System



BLACK C8® coating Class C8 IEC 61537, delivering corrosion resistance superior to hot-dipped galvanized and approaching the level of stainless steel.



| Part Number | | Nominal Dimensions | | Load Rating 5' L (1.5 m) Span | | Splices | Shipping Weight lb (kg) |
|-------------------|--------------|--------------------|---------------|----------------------------------|--------|-----------|----------------------------|
| Zinc Electroplate | BLACK C8 | Height in (mm) | Width in (mm) | lb/ft | kg/m | Min. Qty. | |
| 60212100-003 | 60282100-003 | 2 (60) | 4 (100) | 38.08 | 56.66 | 2 | 6 (2.7) |
| 60212150-003 | 60282150-003 | 2 (60) | 6 (150) | 38.08 | 56.66 | 2 | 7 (3.1) |
| 60212200-003 | 60282200-003 | 2 (60) | 8 (200) | 38.08 | 56.66 | 3 | 9 (4.0) |
| 60212300-003 | 60282300-003 | 2 (60) | 12 (300) | 65.28 | 97.14 | 3 | 14 (6.3) |
| 60212450-003 | 60282450-003 | 2 (60) | 18 (450) | 65.28 | 97.14 | 4 | 18 (8.1) |
| 60212600-003 | 60282600-003 | 2 (60) | 24 (600) | 72.08 | 107.26 | 4 | 23 (10.4) |
| 60213100-003 | 60283100-003 | 4 (100) | 4 (100) | 44.88 | 66.79 | 2 | 9 (4.0) |
| 60213150-003 | 60283150-003 | 4 (100) | 6 (150) | 44.88 | 66.79 | 2 | 10 (4.5) |
| 60213200-003 | 60283200-003 | 4 (100) | 8 (200) | 44.88 | 66.79 | 3 | 14 (6.3) |
| 60213300-003 | 60283300-003 | 4 (100) | 12 (300) | 85.68 | 127.50 | 3 | 17 (7.7) |
| 60213450-003 | 60283450-003 | 4 (100) | 18 (450) | 78.88 | 117.38 | 4 | 22 (9.9) |
| 60213600-003 | 60283600-003 | 4 (100) | 24 (600) | 78.88 | 117.38 | 4 | 26 (11.7) |

Notes: Sold individually. Each tray is 118"L (3 m). Hot-Dipped Galvanized and Stainless Steel finishes are also available with an extended lead time. Please contact CPI Technical Support for additional information.

Cable Tray Support System Accessories



Reinforced Joint Clamp

Use to splice tray sections when forming all end-to-end connections, turns, reductions and intersections. Sold in packs of 50

| Part Number | | Description | Shipping Weight lb (kg) |
|-------------------|--------------|------------------------------------|-------------------------|
| Zinc Electroplate | BLACK C8 | | |
| 64010061-050 | 64080061-050 | Reinforced Joint Clamp, Pack of 50 | 4 (1.8) |



Part Clamp

Use the Part Clamp to install Side Joint Plate and Splice Plate or to secure tray to supports. Sold in packs of 50.

| Part Number | | Description | Shipping Weight lb (kg) |
|-------------------|--------------|------------------------|-------------------------|
| Zinc Electroplate | BLACK C8 | | |
| 64010060-050 | 64080060-050 | Part Clamp, Pack of 50 | 3 (1.3) |



Accessory Clamp Hardware Kit

Use to install Divider Kit and the Radius Drop. Alternative to Part Clamp with loose instead of fixed screw. Sold in packs of 50.

| Part Number | | Description | Shipping Weight lb (kg) |
|-------------------|--------------|--|-------------------------|
| Zinc Electroplate | BLACK C8 | | |
| 64010158-050 | 64080158-050 | Accessory Clamp Hardware Kit, Pack of 50 | 2 (0.9) |



Bonding Connector

Use to attach bonding conductor to tray or across turns and bends where tray sections are removed. Sold in packs of 20.

| Part Number | Description | Shipping Weight lb (kg) |
|--------------|---|-------------------------|
| 68000032-020 | 3-14 AWG, .02-.05 in ² (16-35 mm ²), Pack of 20 | 2 (0.9) |
| 68000033-020 | 1/0-6 AWG, .05-.07 in ² (35-45 mm ²), Pack of 20 | 3 (1.3) |

Cable Tray Support System Accessories

Splice Plate

Use for intersections, reductions and turns that are 120 to 160 degrees. Install with Part Clamp. Sold in packs of 10.



| Part Number | | Description | Shipping Weight lb (kg) |
|-------------------|--------------|--------------------------|-------------------------|
| Zinc Electroplate | BLACK C8 | | |
| 67010053-010 | 67080053-010 | Splice Plate, Pack of 10 | 2 (0.9) |

SPLUS Omega Ceiling Bracket

Use to support trays up to 16" (400 mm) wide from the ceiling. For trays 18" (450 mm) or wider, use RPLUS Medium Duty Cantilever Bracket, SPLUS Omega Channel, or SPLUS Omega Pendant. Install with 3/8" (M10) hardware. Secure tray with built-in click system or optional Part Clamp. Sold in packs of 4.



| Part Number | | Description H x W in (mm) | Shipping Weight lb (kg) |
|---------------|--------------|---------------------------------|-------------------------|
| Pregalvanized | BLACK C8 | | |
| 62022104-004 | 62082104-004 | 7.5 x 4 (190 x 100), Pack of 4 | 4 (1.8) |
| 62022154-004 | 62082154-004 | 7.5 x 6 (190 x 150), Pack of 4 | 5 (2.2) |
| 62022204-004 | 62082204-004 | 7.5 x 8 (190 x 200), Pack of 4 | 6 (2.7) |
| 62022304-004 | 62082304-004 | 7.5 x 12 (190 x 300), Pack of 4 | 7 (3.1) |
| 62022404-004 | 62082404-004 | 7.5 x 16 (190 x 400), Pack of 4 | 8 (3.6) |

SPLUS Omega Bracket

Use to support trays up to 16" (400 mm) wide from the wall. For trays 18" (450 mm) or wider, use RPLUS Medium Duty Cantilever Bracket, SPLUS Omega Channel, or SPLUS Omega Pendant. Install with 3/8" (M10) hardware. Secure tray with built-in click system or optional Part Clamp. Sold in packs of 5.



| Part Number | | Description Width in (mm) | Shipping Weight lb (kg) |
|---------------|--------------|---------------------------|-------------------------|
| Pregalvanized | BLACK C8 | | |
| 62021104-005 | 62081104-005 | 4 (100), Pack of 5 | 3 (1.3) |
| 62021154-005 | 62081154-005 | 6 (150), Pack of 5 | 4 (1.8) |
| 62021204-005 | 62081204-005 | 8 (200), Pack of 5 | 5 (2.2) |
| 62021304-005 | 62081304-005 | 12 (300), Pack of 5 | 7 (3.1) |
| 62021404-005 | 62081404-005 | 16 (400), Pack of 5 | 8 (3.6) |

Cable Tray Support System Accessories

SPLUS Omega Channel

Use to support trays from the ceiling on threaded rod. Install with 3/8" (M10) hardware. Secure tray with built-in click system or optional Part Clamp. Sold in packs of 10.



| Part Number | | Description Width in (mm) | Shipping Weight lb (kg) |
|---------------|--------------|---------------------------------|-------------------------------|
| Pregalvanized | BLACK C8 | | |
| 63022104-010 | 63082104-010 | 4 (100), Pack of 10 | 3 (1.3) |
| 63022154-010 | 63082154-010 | 6 (150), Pack of 10 | 4 (1.8) |
| 63022204-010 | 63082204-010 | 8 (200), Pack of 10 | 5 (2.2) |
| 63022304-010 | 63082304-010 | 12 (300), Pack of 10 | 7 (3.1) |
| 63022404-010 | 63082404-010 | 16 (400), Pack of 10 | 9 (4.0) |
| 63022504-010 | 63082504-010 | 20 (500), Pack of 10 | 11 (4.9) |
| 63022604-010 | 63082604-010 | 24 (600), Pack of 10 | 13 (5.8) |



SPLUS Omega Pendant

Use with SPLUS Omega Bracket to support tray from the ceiling. Install with 3/8" (M10) hardware. Attach SPLUS Omega Brackets with 5/16" (M8) hardware. Sold in packs of 5.

| Part Number | | Description Height in (mm) | Shipping Weight lb (kg) |
|--------------|--------------|----------------------------------|-------------------------------|
| Galvanized | BLACK C8 | | |
| 62021504-005 | 62081504-005 | 20 (500) | 9 (4.0) |
| 62021604-005 | 62081604-005 | 24 (600) | 11 (4.9) |



RPLUS Medium Duty Cantilever Bracket

Use to support tray from the wall. Install with 3/8" (M10) hardware. Secure tray with built-in click system or optional Part Clamp. Sold in packs of 4.

| Part Number | | Description in (mm) | Shipping Weight lb (kg) |
|---------------|--------------|------------------------|-------------------------------|
| Pregalvanized | BLACK C8 | | |
| 62025103-004 | 62085103-004 | 4 (100) | 2 (0.9) |
| 62025153-004 | 62085153-004 | 6 (150) | 3 (1.3) |
| 62025203-004 | 62085203-004 | 8 (200) | 4 (1.8) |
| 62025303-004 | 62085303-004 | 12 (300) | 5 (2.2) |
| 62025403-004 | 62085403-004 | 16 (400) | 7 (3.1) |
| 62025503-004 | 62085503-004 | 20 (500) | 9 (4.0) |
| 62025603-004 | 62085603-004 | 24 (600) | 10 (4.5) |

Cable Tray Support System Accessories

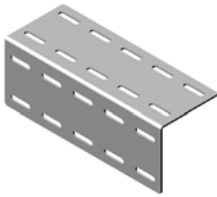

Wall Angle Support Kit

Use to support the end of the tray from the wall. Painted finish matches tray finish. Install with 1/4" (M6) hardware. Secure tray with Part Clamp.

| Part Number | | Description in (mm) | Shipping Weight lb (kg) |
|-------------|-----------|-----------------------------|-------------------------------|
| Silver | BLACK C8 | | |
| 60501-504 | 60501-704 | 4 (100) Wall Angle Support | 1.4 (0.6) |
| 60501-506 | 60501-706 | 6 (150) Wall Angle Support | 1.5 (0.7) |
| 60501-508 | 60501-708 | 8 (200) Wall Angle Support | 1.9 (0.9) |
| 60501-512 | 60501-712 | 12 (300) Wall Angle Support | 2.2 (1.0) |
| 60501-518 | 60501-718 | 18 (450) Wall Angle Support | 4.0 (1.8) |
| 60501-524 | 60501-724 | 24 (600) Wall Angle Support | 4.7 (2.1) |

Note: Painted finish matches tray finish (EZ or C8). Install with 1/4" (M6) hardware. Secure tray with Part Clamp

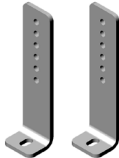

Elevation Kit

Use to attach and elevate tray above the top of equipment cabinets and racks. Painted to match CPI rack/cabinet finish (Glacier White or black). Attach tray to Elevation Kit with Part Clamp. Includes hardware to attach to the top of CPI TeraFrame, GlobalFrame and MegaFrame Cabinets. Use Cable Pathway Elevation Kit (page 3-17) for ZetaFrame Cabinet. Order a Rack-to-Runway Kit separately to attach to CPI two- or four-post racks.

| Part Number | | Description Height in (mm) | Shipping Weight lb (kg) |
|---------------|-----------|----------------------------------|-------------------------------|
| Glacier White | Black | | |
| 60506-E02 | 60506-702 | 2-3 (50-75), Sold in pair | 3 (1.4) |
| 60506-E06 | 60506-706 | 4-6 (100-150), Sold in pair | 3.5 (1.6) |
| 60506-E08 | 60506-708 | 10-12 (250-300), Sold in pair | 4.5 (2) |



Click Central Hanging Plate

Use to support trays under 8"W (200 mm) or less from the ceiling using threaded rod. Install with either 5/16" (M8) or 3/8" (M10) hardware. Sold in packs of 20.

| Part Number | | Description | Shipping Weight lb (kg) |
|-------------------|--------------|---------------------------|-------------------------------|
| Zinc Electroplate | BLACK C8 | | |
| 67010043-020 | 67080043-020 | Hanging Plate, Pack of 20 | 2 (0.9) |

Cable Tray Support System Accessories



Data Outlet Radius Drop

Use to manage cable as it enters/exits the bottom of the tray. 1.7"W (45 mm). Snaps onto the tray. Plastic is UL94-V0 rated, black finish. Sold in packs of 10.

| Part Number | Description | Shipping Weight lb (kg) |
|--------------|-------------------------------------|-------------------------|
| 67020139-010 | Data Outlet Radius Drop, Pack of 10 | 1 (0.4) |

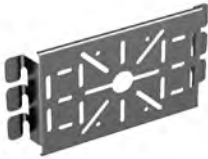

Universal Bracket

Use to attach electrical boxes, security cameras, wireless access points, or other accessory components to the side of the tray. Sold in packs of 10.

| Part Number | | Description | Shipping Weight lb (kg) |
|---------------|--------------|-------------------------------|-------------------------|
| Pregalvanized | BLACK C8 | | |
| 62026011-010 | 62086011-010 | Universal Bracket, Pack of 10 | 4 (1.8) |



Mini Universal Bracket

Sold in packs of 10.

| Part Number | | Description | Shipping Weight lb (kg) |
|---------------|--------------|------------------------------------|-------------------------|
| Pregalvanized | BLACK C8 | | |
| 62026010-010 | 62086010-010 | Mini Universal Bracket, Pack of 10 | 3 (1.3) |



Cable Tie Clip

Use to secure cable bundles to the tray. Snaps onto the tray. Lashing points for cable ties. Plastic is UL94-V0 Rated. Sold in packs of 20.

| Part Number | Description | Shipping Weight lb (kg) |
|--------------|----------------------------|-------------------------|
| 68000110-020 | Cable Tie Clip, Pack of 20 | 1 (0.4) |



Radius Drop

Painted finish matches tray finish. Can be attached to the tray with bendable tabs or with Accessory Clamp Hardware Kit. Sold individually.

| Part Number | | Description Width in (mm) | Shipping Weight lb (kg) |
|-------------|-----------|------------------------------|-------------------------|
| Silver | BLACK C8 | | |
| 60500-501 | 60500-701 | Radius Drop 5.75 (146), Each | 1.7 (0.8) |



SECTION 4

ENVIRONMENTAL MONITORING & SECURITY SYSTEMS

| | |
|--|------|
| Remote Infrastructure Management..... | 4-3 |
| eConnect® RFID Electronic Lock Kit..... | 4-10 |
| Networked RFID Electronic Lock Kit | 4-11 |
| Security System Electronic Lock Kit..... | 4-11 |

ENVIRONMENTAL MONITORING & SECURITY SYSTEMS

Section Update:

- eConnect RFID Electronic Lock Kit Page 4-10
- Networked RFID Electronic Lock Kit Page 4-11
- Security System Electronic Lock Kit Page 4-11

Where Can I Learn More?

To learn more about CPI's Environmental Monitoring & Security Products, or to find additional part numbers not listed in this catalog, please visit our website, chatsworth.com

Related Tools:

Use these tools, under the Resources tab on chatsworth.com, to simplify your planning, selection, order and purchase of CPI Environmental Monitoring & Security Products.

- CPI Product Designer
- CPI Power Selector
- eConnect® Secure Array® Savings Estimator
- Software (eConnect PDUs)

Your Notes Here:





RIM-750
Front view



RIM-750
Rear view

Remote Infrastructure Management (RIM-750)

Features:

- Remote monitoring of sensors in computer and network equipment rooms
- Simple installation and setup
- Web-accessible with a clean, easy-to-use, mobile-friendly web interface that displays sensor readings and trends
- Monitors 8 digital inputs and 4 temperature or temperature/humidity sensors, plus one zone of leak detection with up to 200 feet (60 meters) of Sensor Rope
- USB power inlet allows you to power RIM-750 with the included wall adapter or a USB port on a server or other device, such as the eConnect PDU
- Multiple alarm notification configurations, including audible and visible indicators, email messaging and/or relay activation
- Relay output allows for simple control of an external device upon alarm condition
- Modbus or SNMP output enables simple integration with other facility management systems (BMS)
- Integrated logging and trending, including CSV downloadable trending data

Certifications:

- CE
- ETL listed: conforms to UL 61010-1, EN 61010-1 Certified to CSA C22.2 NO. 61010-1
- RoHS compliant

Specifications:

- Includes:
 - (1) RIM-750, (1) network cable, 3.3 ft (1m) long, (1) USB power adapter with USB mini B to USB A cable
- Power:
 - Power with included wall adapter or from USB port with 5VDC @ 500mA max. output
 - USB mini-B power inlet, (US) 5VDC @ 500mA max.
 - Includes a 110/240VAC 50/60Hz wall adapter with US (type "A") outlet blade and type "C", "G" & "I" adapter blades
- Wired Inputs:
 - Temperature/Humidity: 4 each, 1-wire digital temperature or 1-wire digital temperature/humidity sensor inputs; plug-and-play; configurable alarm points
 - Digital: 8 each, digital alarm points; configurable
 - Leak Detection: 1 each, zone leak detection, supports 200 ft (60 m) of conductive fluid Sensor Rope; Leak Detection Lead Cable and Sensor Rope(s) must be ordered separately
- Relay Output:
 - 1 each, Form C summary relay; 2A @ 30VDC, 0.5A @125VAC; configurable as summary alarm output or manual operation
- Alarm Notification:
 - Panel: Audible alarm, visible LED
 - Integrated Web Interface: Dashboard overview with alarm indicators
 - Email: up to 8 email recipients; email sent on alarm to all recipients, distribution list, or email-to-SMS
 - SNMP Traps: Multiple community strings
 - Relay: 1 Form C summary relay output

| Part Number | Description | Shipping Weight lb (kg) |
|-------------|--|-------------------------|
| 60100-001 | RIM-750, with 4 Temperature/Humidity inputs, 8 digital inputs, 1 leak detection input, 1 relay output, black | 2 (0.9) |
| 60100-002 | RIM-750 and Leak Detection Kit Bundle, includes 1 RIM-750 with a Leak Detection Lead Cable and 200' (60 m) of Leak Detection Sensor Rope | 9 (4.1) |

- Web Interface Login Security:
 - 8 password read only, 8 password read/write
- Communication Port:
 - Ethernet: 10/100 BaseT, RJ45 connector; 500VAC RMS isolation; DHCP enabled; Static IP-addressable
- Protocols:
 - TCP/IP: ARP, DNS, UDP, DHCP, ICMP
 - HTML: Supports multiple simultaneous connections
 - SMTP (email): SMTP authentication; SMTP relay; supports SSL; up to 8 recipients
 - Modbus TCP/IP: Modbus slave; TCP/IP transmission protocol
 - SNMP: V1; V2C MIB-2 compliant; NMS manageable with Get and Traps; V2C Get, V2C and V1 Traps
 - NTP: Custom server settings
- Logging: Logs 50 most recent alarm and return to normal events with date/time stamp.
- Trending: Records up to 86,400 points of sensor data. Sample interval set from 1 second to 1 day. CSV downloadable.
- Operating Environment
 - Temperature: -40°F to 185°F (-40°C to 85°C)
 - Humidity: 0% to 100% RH, non-condensing
 - Altitude: 15,000ft (4,572m) max.
 - Storage Environment: -40°F to 185°F (-40°C to 85°C)
- Dimensions: 1.00" H x 5.63" W x 2.63" D (25mm x 143mmW x 67mmD)
- Weight: 10.1 oz. (287g)
- Mounting: Stand alone; keyholes included for wall mount; rack-mount bracket available



Rack-Mount Bracket

- Holds (2) RIM-750 units
- 1U x 19" EIA x 3"D (76 mm)
- Black Finish

| Part Number | Description | Shipping Weight lb (kg) |
|-------------|--|-------------------------|
| 60107-001 | Rack-Mount Bracket, 1U x 19" EIA x 3" D (76 mm) | 1 (0.5) |



60114-002
shown

Sensors

| Part Number | Sensors for RIM-750 | Shipping Weight lb (kg) |
|---|---|-------------------------|
| Temperature and Humidity Sensors | | |
| 60108-001 | Temperature Sensor, RJ11, 25'L (7.6 m) cord | 1 (0.5) |
| 60108-002 | Temperature and Humidity Sensor, RJ11, 25'L (7.6 m) cord | 1 (0.5) |
| Digital Input, Sensors * | | |
| 60109-001 | Leak Spot Detector, with 14'L (4.2 m) cable* | 1 (0.5) |
| 60113-002 | Smoke Detector, Power Supply included | 2 (0.9) |
| 60114-002 | Motion Detector, Power Supply included | 2 (0.9) |
| 60115-001 | Magnetic Door Sensor | 1 (0.5) |
| Leak Detection, Sensors | | |
| 60116-001 | Leak Detection Lead Cable, 15'L (4.57 m) and End of Line Terminator* | 1 (0.5) |
| 60109-003 | Leak Detection Sensor Rope, 10 ft L (3.0 m) | 1 (0.5) |
| 60109-004 | Leak Detection Sensor Rope, 25 ft L (7.6 m) | 1 (0.5) |
| 60109-005 | Leak Detection Sensor Rope, 50 ft L (15.2 m) | 3 (1.4) |
| 60109-006 | J-Clips, to install Sensor Rope, Pack of 10 | 1 (0.5) |
| 60109-007 | J-Clips, to install Sensor Rope, Pack of 50 | 1 (0.5) |

Note: The RIM-750 has four connections for temperature and humidity sensors, eight connections for digital input sensor, and one built-in single-zone leak detection controller that supports up to 200 feet (60 m) of Sensor Rope, one Leak Detection Lead Cable is required to attach Sensor Rope(s) to the RIM-750. Connect Sensor Ropes end-to-end to extend length, as required. Do not exceed 200 feet (60 m).

Alternately, you can use up to four Leak Spot Detectors, which attach to one of the eight digital inputs on the RIM-750. When using a mix of Sensor Rope and Leak Spot Detectors, each Leak Spot Detector reduces the total footage of Sensor Rope supported by the built-in single-zone controller by 50 feet (15.2 m). For example, if you use two leak Spot Detectors, the RIM-750 will only support up to 100 feet (30 m) of Sensor Rope. Smoke Detector and Motion Sensor require an external power source (a VAC power supply is included).



RIM-1000
Front view



RIM-1000
Rear view

Remote Infrastructure Management (RIM-1000)

Features:

- Remote monitoring of sensors and devices in your data centers and equipment rooms
- Configurable with expansion cards for a large number of sensor inputs
- Provides one integrated view of all facility equipment
- Accepts inputs from a wide range of environmental sensors and facility equipment
- Stores data internally, so there is no need for additional equipment or software to store or access data
- Provides a single web-based interface for accessing and reviewing all data
- Monitors user-set thresholds and sends SNMP traps, email or SMS alarm notifications for events
- Provides Modbus, BACnet and SNMP output for integration with other facility management systems

Certifications:

- CE
- ETL listed: conforms to UL 61010-1, EN 61010-1 Certified to CSA C22.2 NO. 61010-1
- RoHS compliant



Expansion Cards (RIM-1000)

You can add expansion cards to the RIM-1000 to provide additional connections for external sensors and additional relay outputs. When selecting an expansion card, check your RIM-1000 to be sure there is an open expansion card slot and be sure to match the input voltage of your RIM-1000 (24 VDC or 48 VDC).

| Part Number | Description | Shipping Weight lb (kg) |
|-------------|---|-------------------------|
| 60103-001 | Expansion Card A, for 24 VDC or 48VDC RIM-1000, 12 configurable analog or digital NO inputs*, 8 relay outputs (maximum one can be installed in a 48 VDC RIM-1000) | 1 (0.5) |
| 60103-002 | Expansion Card C, for 24 VDC RIM-1000, 24 digital NO/NC inputs | 1 (0.5) |

Note: 1U units have 1 expansion card slot. 2U units have 4 expansion card slots. An internal modem (for pager and PPP/dialup connections), and wall mount brackets are also available.

Specifications/RIM-1000:

- Includes:
 - (1) RIM-1000; (1) Power Supply with 24VDC models only and (1) Rack-mount brackets
- Power:
 - 1U, 24VDC Model: 24VDC ($\pm 10\%$), 1A max., external power supply included
 - 1U, 48VDC Model: 36-72VDC, 0.5A max., power input terminal block
 - 2U, 24VDC Model: 24VDC ($\pm 10\%$), 2.5A max., external power supply included
 - 2U, 48VDC Model: 36-72VDC, 1.25A max., power input terminal block
- Grounding: External ground point for chassis and EIA-485
- Inputs:
 - Analog/Digital: 8 Configurable as 4-20mA (12-bit A/D conversion) or Dry Contact NO/NC (<25mA)
 - Keypad: Standard 3x4; 3000VAC RMS optically isolated; 20 User Access Codes (accessible via phone/DTMF through modem)
- Outputs:
 - Relay: 2 Dry Contact, Form C, 1A @ 24VDC, 0.5A resistive @ 120VAC (controllable via user programmable logic)
 - Sensor/Accessory Power: 24VDC ($\pm 10\%$) @ 300mA max. (power for external sensors and/or devices)
- Expansion Cards:
 - 1U model accommodates 1 expansion card
 - 2U model accommodates up to 4 expansion cards
 - 24VDC model requires 24VDC expansion cards
 - 48VDC model requires 48VDC expansion cards
 - Expansion Card A: 12 analog (jumper selectable for 4-20mA, 0-5VDC or 0-10VDC) or digital normally open (NO) dry contact inputs (non-isolated, individual ground only); and 8 Form C Relay Outputs, 1A @ 24VDC, 0.5A resistive @ 120VAC. 48VDC model accepts only 1 Card A.
 - Expansion Card C: 24 digital normally open or normally closed dry contact inputs, 3000VAC RMS optically isolated (common or individual ground)
- Communication Ports:
 - Ethernet: 10/100BaseT, RJ45 connector; 500VAC RMS isolation
 - RS-232: DB9 female connector; 9600 baud; 3000VAC RMS optically isolated; 15kV ESD protection
 - EIA-485 (selectable as RS-232): Two-wire half duplex; terminal block (selecting RS-232 switches to DB9 male connector); 1200, 2400, or 9600 baud configurable; 3000VAC RMS optically isolated 3000VAC RMS optically isolated
 - Modem (RJ11 Telco; ordered separately): V.34bis/33.6 kbps; DTMF capable; PPP-enabled; FCC Part 68 approved; 1500VAC RMS isolation barrier; 2100V peaksurge protection
- Protocols:
 - TCP/IP; UDP/IP; ICMP/IP; FTP; NTP: IPv4
 - HTTP/HTML; SNMP; Telnet: 1.1/4.0; up to 10 URL links to other IP addressable cameras/devices; Webpages comply with Rehabilitation Act of 1973, sections 504 and 508, US Dept. of Education with disabilities)
- SNMP: V1: MIB-2 compliant; NMS Manageable with Get, Set, and Traps; V2c: Traps or Informis
- SMTP (email): Supports Client Authentication (plain and login); compatible with ESMTP Servers
- Protocols:
 - Modbus: RTU transmission protocol; function codes: Slave - 03; Master - 01, 02, 03, 04
 - Modbus/IP: Modbus Slave; TCP/IP transmission protocol; Reads up to 628 registers and converts to SNMP and BACnet
 - BACnet/IP: Reads up to 106 instances and converts to SNMP and Modbus
 - Terminal Emulation: VT100 compatible
 - TAP (Pager): Telocator Alphanumeric Protocol v1.8
- Alarm Notification
 - Pager (With Optional Modem) – Optional: 15 text, numeric, or alphanumeric pager numbers
 - Email (Ethernet, With Optional Modem through PPP): 8 email recipients; email sent on Alarm and Return To Normal
 - SNMP Traps (Ethernet): V1 and V2c: 4 Trap IPs/Community Strings
 - Escalation (with Optional Modem): Additional notification to 1 of the 15 pager numbers when the initial page results in a Failure To Acknowledge status
- Health Check/Self-Monitoring: Self resetting; captured in Log
- Internal Hardware:
 - Real Time Clock: Battery backed; ± 1.5 min/month accuracy
 - Memory: 16MB RAM; 128K NVRAM; 16MB Flash
- Logging Capabilities:
 - Alarm Log: Last 256 Alarms
 - Event Log: Last 100 Events
- Logging Capabilities:
 - Web User Access Log: Last 100 HTML Accesses
 - Digital Status Log: Last 100 Digital Status entries
 - Trending of Analog Inputs: 244 entries per time frame, per channel. High, low, and average values logged
 - Extended Trending (Analog Inputs): 3,840 entries over 32 inputs, physical or over Modbus. Logging at defined, user-selectable intervals.
- Login Security:
 - Web Browser Access (Ethernet, Modem, PPP): 1 Administrator plus 7 users
 - Terminal Emulation Access (Modem): 1 Administrator
- Front Panel Interface: 1 on/off power switch. Red and green LEDs indicate status, network link, network and modem activity
- Operating/Storage Environment:
 - Operating temperature: 32° to 158°F (0° to 70°C).
 - Humidity: 5% to 95% RH, non-condensing.
 - Altitude: 15,000ft (4,572m) max.
 - Storage temperature: -40° to 185°F (-40°C to 85°C)
- Dimensions and Weight:
 - 1U Model: 1.8"H x 16.8"W x 7.9"D (46mmH x 427mmW x 201mmD); 6 lb (2.72 kg)
 - 2U Model: 3.5"H x 16.8"W x 7.9"D (89mmH x 427mmW x 201mmD); 10 lb (4.54 kg)
- Mounting: 19" EIA, rack-mount brackets included; wall mount brackets available (sold separately)

Ordering Information:



RIM-1000
Shown

| Part Number | (RIM-1000) System – 24 VDC Models | Shipping Weight lb (kg) |
|-------------|--|-------------------------|
| 60101-001 | 1U, 24VDC, 8 configurable analog or digital NO/NC inputs, 2 relay outputs, 1 open expansion card slot, black | 11 (5.0) |
| 60101-002 | 1U, 24VDC, 8 configurable analog or digital NO/NC inputs, 12 configurable analog or digital NO inputs*, 10 relay outputs, no open expansion card slots, black | 11 (5.0) |
| 60101-003 | 1U, 24VDC, 8 configurable analog or digital NO/NC inputs, 24 digital NO/NC input, 2 relay outputs, no open expansion card slots, black | 11 (5.0) |
| 60101-004 | 2U, 24VDC, 8 configurable analog or digital NO/NC inputs, 2 relay outputs, 4 open expansion card slots, black | 16 (7.3) |
| 60101-005 | 2U, 24VDC, 8 configurable analog or digital NO/NC inputs, 12 configurable analog or digital NO inputs*, 10 relay outputs, 3 open expansion card slots, black | 16 (7.3) |
| 60101-006 | 2U, 24VDC, 8 configurable analog or digital NO/NC inputs, 24 digital NO/NC inputs, 2 relay outputs, 3 open expansion card slots, black | 16 (7.3) |
| 60101-007 | 2U, 24VDC, 8 configurable analog or digital NO/NC inputs, 12 configurable analog or digital NO inputs*, 24 digital NO/NC inputs, 10 relay outputs, 2 open expansion card slots, black | 16 (7.3) |
| 60101-008 | 2U, 24VDC, 8 configurable analog or digital NO/NC inputs, 24 configurable analog or digital NO inputs*, 18 relay outputs, 2 open expansion card slots, black | 16 (7.3) |
| 60101-009 | 2U, 24VDC, 8 configurable analog or digital NO/NC inputs, 48 digital NO/NC inputs, 2 relay outputs, 2 open expansion card slots, black | 16 (7.3) |
| 60101-010 | 2U, 24VDC, 8 configurable analog or digital NO/NC inputs, 48 configurable analog or digital NO inputs*, 34 relay outputs, no open expansion card slots, black | 16 (7.3) |
| 60101-011 | 2U, 24VDC, 8 configurable analog or digital NO/NC inputs, 96 digital NO/NC inputs, 2 relay outputs, no open expansion card slots, black | 16 (7.3) |
| 60101-012 | 2U, 24VDC, 8 configurable analog or digital NO/NC inputs, 12 configurable analog or digital NO inputs*, 72 digital NO/NC inputs, 10 relay outputs, no open expansion card slots, black | 16 (7.3) |

Note: The 12/24/48 configurable analog or digital NO inputs in these models are configured for a 4-20mA input, but can be manually reconfigured to 0-5 VDC or 0-10 VDC inputs by changing jumper settings on the expansion card. 48 VDC Models are also available. Refer to the Technical Data Sheet for detailed specifications.*

 60114-002
shown

| Part Number | Analog Input, Sensors for RIM-1000 | Shipping Weight lb (kg) |
|-------------------------------------|---|-------------------------|
| 60111-001 | Temperature Sensor, No Display, 50°F to 95°F (10°C to 35°C) | 1 (0.5) |
| 60111-002 | Temperature Sensor, With Display, Selectable Range 50°F to 95°F (10°C to 35°C) or 32°F to 122°F (0°C to 50°C) | 1 (0.5) |
| 60111-003 | Humidity Sensor, No Display, 2% Accuracy RH | 1 (0.5) |
| 60111-004 | Temperature and Humidity Sensor, No Display, 2% Accuracy RH, Selectable Temperature Range 50°F to 95°F (10°C to 35°C) or 32°F to 122°F (0°C to 50°C) | 1 (0.5) |
| 60111-005 | Temperature and Humidity Sensor, With Display, 2% Accuracy RH Selectable Temperature Range 50°F to 95°F (10°C to 35°C) or 32°F to 122°F (0°C to 50°C) | 1 (0.5) |
| 60111-006 | Temperature and Humidity Sensor, No Display, 3% Accuracy RH, Selectable Temperature Range -20°F to 140°F (-28.9°C to 60°C); 0°F to 100°F (-17.8°C to 37.8°C); 40°F to 90°F (4.4°C to 32.3°C); or -4°F to 140°F (-20°C to 60°C), | 1 (0.5) |
| 60111-007 | Temperature and Humidity Sensor, With Display, 3% Accuracy RH, Selectable Temperature Range -20°F to 140°F (-28.9°C to 60°C); 0°F to 100°F (-17.8°C to 37.8°C); 40°F to 90°F (4.4°C to 32.3°C); or -4°F to 140°F (-20°C to 60°C), | 1 (0.5) |
| 60112-001 | Temperature Sensor, Miniature, 40°F to 100°F (4°C to 38°C) Range, with 18" L (450 mm) Lead Cable | 1 (0.5) |
| 60112-002 | Temperature Sensor, Miniature, 40°F to 100°F (4°C to 38°C) Range, with 5' L (1.5 m) Lead Cable | 1 (0.5) |
| 60112-003 | Temperature Sensor, Miniature, 40°F to 100°F (4°C to 38°C) Range, with 25' L (4.5 m) Lead Cable | 1 (0.5) |
| Digital Input, Sensors for RIM-1000 | | |
| 60109-001 | Leak Spot Detector, with 14' L (4.2 m) cable | 1 (0.5) |
| 60109-002 | Leak Detection Controller Kit, 10 ft (3 m) Sensor Rope, Power Supply | 1 (0.5) |
| 60109-003 | Leak Detection Sensor Rope, 10 ft L (3.0 m) | 1 (0.5) |
| 60109-004 | Leak Detection Sensor Rope, 25 ft L (7.6 m) | 1 (0.5) |
| 60109-005 | Leak Detection Sensor Rope, 50 ft L (15.2 m) | 3 (1.4) |
| 60109-006 | J-Clips, adhesive backing, to install Sensor Rope, Pack of 10 | 1 (0.5) |
| 60109-007 | J-Clips, adhesive backing, to install Sensor Rope, Pack of 50 | 1 (0.5) |
| 60110-001 | Power Fail Monitor, with one 120 VAC, 15A (NEMA 5-15P) connection | 1 (0.5) |
| 60113-001 | Smoke Detector | 1 (0.5) |
| 60114-001 | Motion Sensor | 1 (0.5) |
| 60115-001 | Magnetic Door Sensor | 1 (0.5) |

Note: Each combination Temperature and Humidity Sensor uses two Analog Inputs on the RIM-1000, one for temperature and one for humidity. Use Leak Spot Detector to monitor a specific spot for liquid. Use Leak Detection Controller Kit and additional Sensor Rope, if needed, to monitor an area. Leak Detection Controller Kit uses two digital inputs on the RIM-1000, one for leak detection and one for cable break. Sensors require power from the RIM-1000 or another power source. Refer to the Data Sheet for sensor specifications.

Remote Infrastructure Management (RIM) Protocol Converter

The Protocol Converter is ideal for environments where data from monitored equipment is incompatible with the protocols used by the BMS or NMS, especially in applications that feature legacy monitoring systems.

- Multiple input and output protocols allow easy integration with a wide variety of equipment
- Communicates with building management and network management systems
- Web-based interface simplifies setup and configuration
- Connects up to 32 devices (units, modules, or nodes)
- Monitors up to 1,024 Modbus registers, OID, or instances
- Use the dual port Protocol Converter to connect to multiple trunk lines for faster polling with a large number of devices
- Alarm notification through email when a device stops communicating



60106-001
Single Port



60106-002
Dual Port

| Part Number | Description | Shipping Weight lb (kg) |
|-------------|--|-------------------------|
| 60106-001 | RIM Protocol Converter, SNMP/Modbus/BACnet, Single Port, black | 5 (2.3) |
| 60106-002 | RIM Protocol Converter, SNMP/Modbus/BACnet, Dual Port, Black | 5 (2.3) |

Note: Includes (1) Protocol Converter, (1) external power supply and (1) network crossover cabler for initial configuration.



RFID Electronic Lock Kit

The Electronic Lock Kit solution can be preinstalled in CPI GlobalFrame® and TeraFrame® cabinets and features swinghandles with integrated dual-frequency card reader technology. Audit trail capability allows for enhanced regulatory compliance.

Features:

- Integrated RFID Card Reader – Separate lock options recognize existing employee 125 kHz or 13.56 MHz RFID cards, including HID, iClass®, MIFARE® and DESFire technologies
- Future-proof Design – Modular reader allows the use of the same swinghandle as card technologies evolve
- Flexible Management – Multiple methods of integration: through eConnect PDUs, networked controller or building security access control system
- Regulatory Compliance – Allows audit trail to be maintained for every access attempt within DCIM software or access control systems in order to comply with HIPAA, PCI DSS, GDPR, FISMA, Saas SOC 2®, HITECH and more
- Quick Deployment – Locks can be factory-preinstalled into CPI TeraFrame and GlobalFrame cabinets
- eConnect Integration – Eliminates the need for a separate IP address or a separate source of power for the lock. Saves significant deployment costs normally associated with wiring the locks to security panels
- Remote Access Control – Ability to remotely open/close doors allows administrators to provide access to contractors without badges
- Centralized Authentication – Ability to use the permissions set within RADIUS server to provide higher levels of security



eConnect RFID Electronic Lock Kit

eConnect RFID Electronic Lock Kit is a front and rear single-factor, 12V lock solution that is activated by RFID cards and fully integrates into networked eConnect power distribution units PDUs (P/N EX-XXXX only), so that no additional appliance or external software are required. Available on vertical Monitored, Monitored Pro, Switched and Switched Pro PDUs.

Kit includes:

- 12 Volt locks
- Front and rear swinghandles
- 3 door sensors (front and rear doors)
- 2 wiring harnesses (for front and rear connection)
- 2 mechanical override keys

| Part Number | Description | Shipping Weight lb (kg) |
|-------------|-------------------------------------|-------------------------|
| 14666-001 | eConnect® RFID Electronic Lock Kit | 3 (1.4) |
| 14665-001 | USB Temperature and Humidity Sensor | 1 (0.5) |
| 36651-001 | Wire Harness Kit | 1 (0.5) |
| 36652-001 | Door Sensor Kit | 1 (0.5) |
| 36653-001 | RF IDEas EAC Smart Card Reader | 1 (0.5) |
| 36654-001 | RFID Cards, Pack of 20 | 1 (0.5) |

Note: Use this kit with eConnect PDUs with eConnect Controller 4 (MCM4) only.



Networked RFID Electronic Lock Kit

Networked RFID Electronic Lock Kit provides a networked electronic lock solution for physical security of data center cabinets. Secure Array IP Consolidation technology connects up to 32 controllers (32 cabinets) under one IP address, providing significant savings in networking costs. The controller module features a Gigabit Ethernet port and a built-in web interface.

Kit includes:

- 12 Volt locks
- Capability to integrate with USB Temperature and Humidity Sensor
- Front and rear swinghandles
- 3 door sensors (front and rear doors)
- 2 wiring harnesses (for front and rear connection)
- 2 mechanical override keys

| Part Number | Description | Shipping Weight lb (kg) |
|-------------|-------------------------------------|-------------------------|
| 14667-001 | Networked RFID Electronic Lock Kit* | 7 (3.2) |
| 14665-001 | USB Temperature and Humidity Sensor | 1 (0.5) |
| 36653-001 | RF IDEas EAC Smart Card Reader | 1 (0.5) |
| 36654-001 | RFID Cards, Pack of 20 | 1 (0.5) |

Note: Use with 125 kHz CSN and/or 13.56 MHz UID RFID cards. Does not support PACS smart cards.



Security System RFID Electronic Lock Kit

Security System RFID Electronic Lock solution that integrates with Wiegand-based security panels. It supports connection for two separate channels for independent system control.

Kit includes:

- Front and rear swinghandles
- 3 door sensors (front and rear doors)
- 2 wiring harnesses (for front and rear connection)
- 2 mechanical override keys

| Part Number | Description | Shipping Weight lb (kg) |
|-------------|--|-------------------------|
| 14668-001 | Security System RFID Electronic Lock Kit | 3 (1.4) |
| 14665-001 | USB Temperature and Humidity Sensor | 1 (0.5) |
| 36653-001 | RF IDEas EAC Smart Card Reader | 1 (0.5) |
| 36654-001 | RFID Cards, Pack of 20 | 1 (0.5) |

Note: Use with 125 kHz CSN and/or 13.56 MHz UID RFID cards. Does not support PACS smart cards.

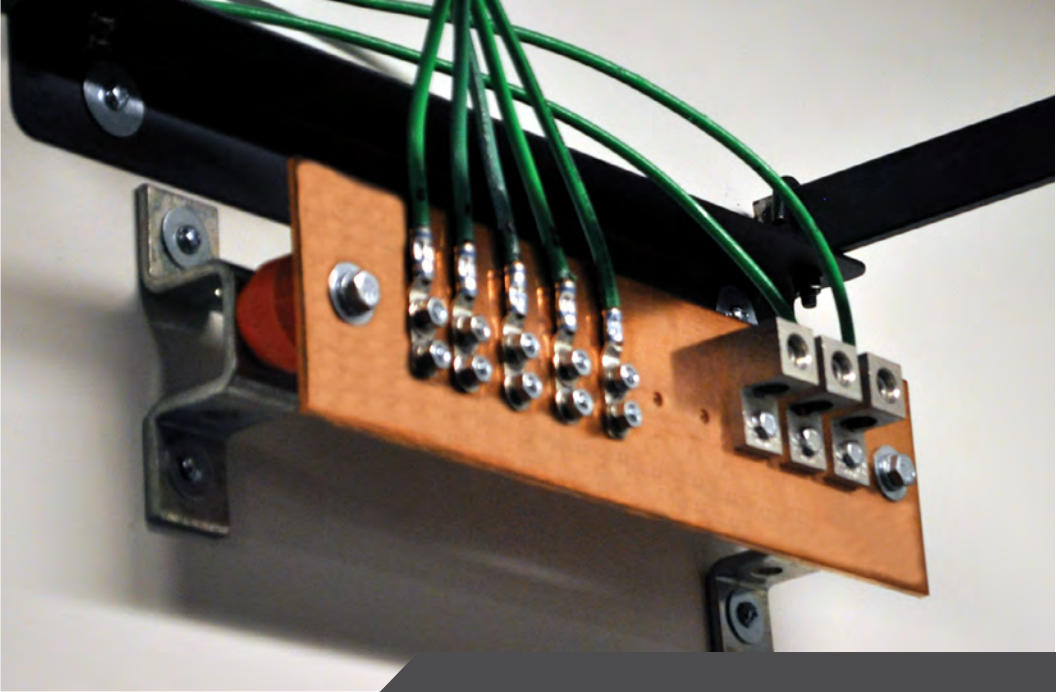

SECTION 5

BONDING & GROUNDING PRODUCTS

| | |
|-------------------------------------|------|
| Busbars..... | 5-3 |
| Insulators..... | 5-8 |
| Bonding Products | 5-9 |
| Compression Tools, Lugs & Taps..... | 5-14 |

BONDING & GROUNDING PRODUCTS

In response to the increase in newer, more sensitive, highly sophisticated electronic equipment, CPI offers a comprehensive line of UL® Listed Bonding & Grounding Products that are designed to provide protection and prevent transient voltages from damaging sensitive electronic equipment.

Where Can I Learn More?

To learn more about CPI's Bonding & Grounding Products, or to find additional part numbers not listed in this catalog, please visit our website, chatsworth.com

Related Tools:

Use these tools, under the Resources tab on chatsworth.com, to simplify your planning, selection, order and purchase of CPI Bonding & Grounding Products.

- BIM Drawings
- MasterFormat Specs
- OSHPD Products
- Visio Shapes

Your Notes Here:

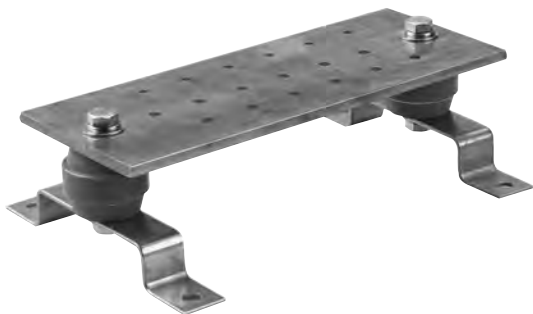

CPI Standard Busbar



BICSI & ANSI /TIA Bonding Busbars

The CPI 13622 series Secondary Bonding Busbar (SBB) provides a central bond attachment point for ICT systems located in the data room. The CPI 40153 series ICT Primary Bonding Busbar (PBB) provides a central bond attachment point for ICT bonding backbones, equipment and the building's ground electrode system. All CPI Bonding Busbars are UL Listed.

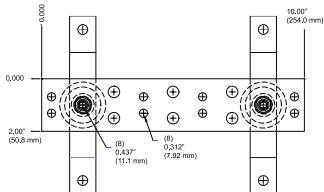

13622-010: (4) Lugs, 5/8" (15.88 mm) hole centers
(3) Lugs, 1" (25.4 mm) hole centers

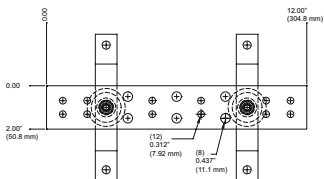

13622-012: (16) Lugs, 5/8" (15.88 mm) hole centers
(3) Lugs, 1" (25.4 mm) hole centers

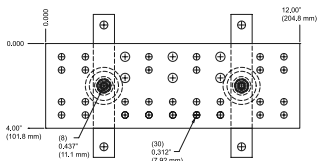

40153-012: (15) Lugs, 5/8" (15.88 mm) hole centers
(3) Lugs, 1" (25.4 mm) hole centers

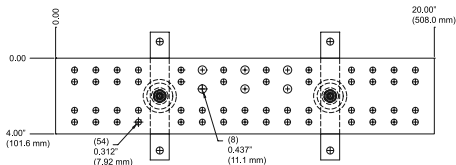

40153-020: (27) Lugs, 5/8" (15.88 mm) hole centers
(3) Lugs, 1" (25.4 mm) hole centers

Hole patterns on Busbars accommodate two-hole lugs per the recommendation of ANSI/BICSI N3-20 and ANSI/TIA-607 standards. Insulators electrically isolate Busbars from the wall or other mounting surfaces, thereby controlling the current path.

- Mounting brackets are manufactured from high-quality 300 series stainless steel with 3/8" (9.53 mm) diameter mounting holes spaced 5.75" (146.1 mm) apart
- Busbars mount on the wall, floor or ceiling
- Ships preassembled
- Sold individually
- UL Listed, File E236184, Category KDER (US), KDER7 (Canada)
- Busbar assemblies with lug kits also available
- Other configurations available on request

Each Busbar consists of:

- (1) Busbar
- (2) insulators
- (2) stand-off brackets
- (4) stainless steel bolts with Torx T-45 head
- Order installation hardware separately

| Part Number | Description | Busbar Size H x W x D in (mm) | Shipping Weight lb (kg) |
|-------------|--------------|-------------------------------------|----------------------------|
| 13622-010 | 10 (250) SBB | 2 x 10 x 1/4 (50 x 250 x 6.4) | 3 (1.4) |
| 13622-012 | 12 (300) SBB | 2 x 12 x 1/4 (50 x 300 x 6.4) | 4 (1.8) |
| 40153-012 | 12 (300) PBB | 4 x 12 x 1/4 (100 x 300 x 6.4) | 7 (3.2) |
| 40153-020 | 20 (510) PBB | 4 x 20 x 1/4 (100 x 510 x 6.4) | 8 (3.6) |

Note: See details at left for lug sizes and quantities. Overall height with stand-off brackets is 6.63" (168 mm); overall depth is 3.13" (80 mm).

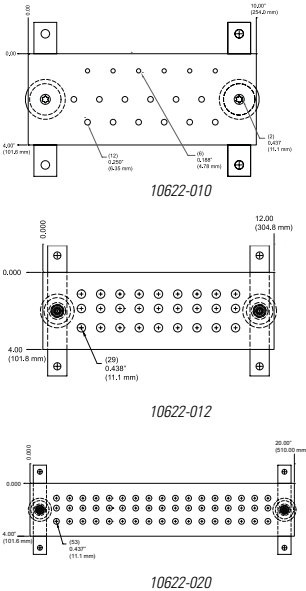

Standard Busbars

CPI Standard Busbars are insulated ground bus-mounting plates specifically designed for commercial applications. The hard-drawn electrolytic tough pitch 110 alloy solid copper ground bars are 1/4" (6.4 mm) thick and stand off 2.75" (69.9 mm) from the backboard or wall. The 10" (250 mm) Busbar accepts 1/4" single bolt lugs. The 12" and 20" (300 mm and 510 mm) Busbars provide connection for nine or 17 lugs respectively, accepting lugs with either 3/4", 1" or 1-3/4" (19.1 mm, 25 mm or 44.5 mm) center. Any lug with 3/8" bolts may be used.

- All Busbars ship individually and preassembled
- Other configurations available on request
- UL Listed, File E236184; Category KDER (US), KDER7 (Canada)

Each Busbar assembly consists of:

- (1) Busbar
- (2) insulators
- (2) stand-off brackets
- (4) stainless steel bolts with Torx T-45 head
- Order installation hardware separately

| Part Number | Description | Busbar Size H x W x D in (mm) | Shipping Weight lb (kg) |
|-------------|-------------|--------------------------------|-------------------------|
| 10622-010 | Busbar | 4 x 10 x 1/4 (100 x 250 x 6.4) | 4 (1.8) |
| 10622-012 | Busbar | 4 x 12 x 1/4 (100 x 300 x 6.4) | 5 (2.3) |
| 10622-020 | Busbar | 4 x 20 x 1/4 (100 x 510 x 6.4) | 8 (3.6) |

Overall height with stand-off brackets is 6.63" (168 mm); overall depth is 3.13" (80 mm).

Busbar Insulator Assemblies

CPI also offers standalone Busbar Insulator Assemblies.

- Ships preassembled
- Replaces CPI P/N 13622-000

Pair of assemblies consists of:

- (2) stainless steel bolts, 3/8"W x 5/8"L
- (4) lock washers, 3/8"
- (4) flat washers, 3/8"
- (2) stainless steel bolts, 3/8"W x 3/4"L
- (2) insulators, 1-3/4"W x 1-7/8"D, 3/8" threaded insert
- (2) stainless steel wall brackets, 1"W (25 mm), 1" standoff
- Order installation hardware separately

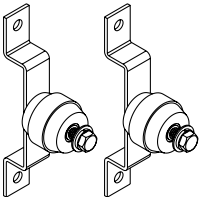

Sold in pairs

| Part Number | Description | Shipping Weight lb (kg) |
|-------------|-------------------------------------|-------------------------|
| 10622-000 | Busbar Insulator Assemblies, 1 Pair | 2 (0.9) |

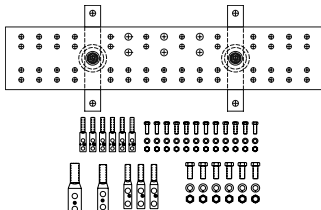

Busbar Assemblies With Lug Kits

Busbar Assemblies with Lug Kits contain the CPI 13622 series Telecommunications Secondary Bonding (SBB) or the CPI 40153 series Primary Bonding Busbar (PBB), along with required stainless steel hardware to fasten the two-hole bonding lugs to the Busbar.

- #6 lugs are 2-hole lugs with 1/4" hardware
- #2, 2/0 and 4/0 lugs are 2-hole lugs with 3/8" hardware
- Order installation hardware separately
- UL Listed, File E236184, Category KDER (US), KDER7 (Canada) - Grounding and Bonding Equipment

40158-020 Shown

| Part Number | Description | Busbar Size H x W x D in (mm) | #2 Lug | #6 Lug | 2/0 Lug | 4/0 Lug | Shipping Weight lb (kg) |
|-------------|-------------|-------------------------------------|--------|--------|---------|---------|----------------------------|
| 40156-012 | SBB Pattern | 2 x 12 x 1/4 (50 x 300 x 6.4) | 3 each | 6 each | 1 each | 0 each | 5 (2.3) |
| 40158-020 | PBB Pattern | 4 x 20 x 1/4 (100 x 510 x 6.4) | 3 each | 6 each | 1 each | 1 each | 11 (5.0) |
| 40158-012 | PBB Pattern | 4 x 12 x 1/4 (100 x 300 x 6.4) | 3 each | 6 each | 1 each | 1 each | 8 (3.6) |

Overall height with stand-off brackets is 6.63" (168 mm); overall depth is 3.13" (80 mm).

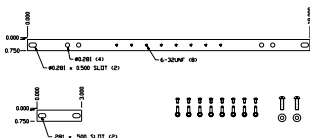

19" rack width Busbar shown

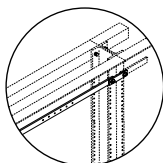

Shown mounted to rack

Horizontal Rack Bonding Busbar

Horizontal Rack Bonding Busbar (RBB) for consolidating equipment bonding conductors. Constructed of 3/16"-thick x 3/4"H (4.763 mm x 19.1 mm) hard-drawn electrolytic tough pitch 110 alloy copper bar with eight #6-32 tapped lug mounting holes on 1" (25.4 mm) centers and two pairs of 5/16" (7.938 mm) diameter holes spaced 3/4" (19.1 mm) apart for attaching equipment bonding conductors.

- Other configurations available on request
- UL Listed, File E236184, Category KDER (US), KDER7 (Canada) - Grounding and Bonding Equipment

Part number consists of Busbar and a hardware kit that includes:

- (1) splice plate bar, 3" L (80 mm)
- (2) #12-24 copper machine screws
- (2) #12 copper flat washers
- (8) #6-32 copper machine screws
- (8) #6 ring terminals
- Order installation hardware separately

| Part Number | Description | Rack Width (in) | Shipping Weight lb (kg) |
|-------------|--------------------------------|-----------------|-------------------------|
| 10610-019 | Horizontal Rack Bonding Busbar | 19 | 2 (0.9) |
| 10610-023 | Horizontal Rack Bonding Busbar | 23 | 3 (1.4) |
| 10610-035 | Horizontal Rack Bonding Busbar | 35 | 4 (1.8) |

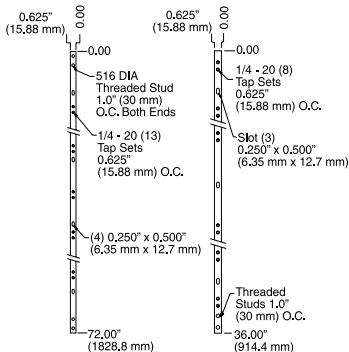

Vertical Rack Bonding Busbar

Vertical Rack Bonding Busbar (RBB) for consolidating equipment bonding connections. Constructed of 5/8" H x 1/4" W (15.88 mm x 6.4 mm) hard-drawn electrolytic tough pitch 110 alloy copper bar with pairs of #1/4-20 tapped mounting holes on 5/8" (15.88 mm) centers. The 36" L (910 mm) bar has one set of #5/16 self-clinching studs on 1" (25.4 mm) centers at one end for attachment of a bonding conductor. The 72" L (1830 mm) bar has two sets of #5/16 self-clinching studs on 1" (25.4 mm) centers at both ends for attachment of a bonding conductor.

- Each package contains one Vertical Rack Busbar
- Vertical Rack Busbars with insulators and lug kits are also available
- Other configurations are available on request
- UL Listed, File E236184, Category KDER (US), KDER7 (Canada) - Grounding and Bonding Equipment

| Part Number | Description W x D x L in (mm) | Number of Lugs | Shipping Weight lb (kg) |
|-------------|-------------------------------------|-------------------|-------------------------------|
| 40160-036 | 5/8 x 1/4 x 36 (15.88 x 6.4 x 910) | 8 | 4 (1.8) |
| 40160-072 | 5/8 x 1/4 x 72 (15.88 x 6.4 x 1830) | 13 | 5 (2.3) |

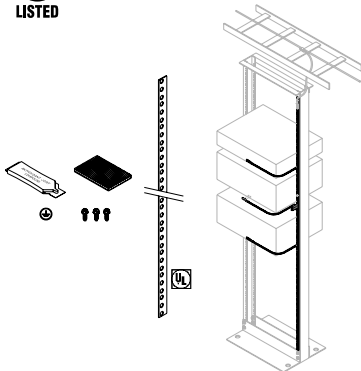

Vertical Rack Bonding Busbar Kit

The Rack Bonding Busbar (RBB) Kit includes a thin strip of tinned copper that attaches to the rack's equipment mounting rail to provide direct bonding contact for rack-mount equipment or a convenient bonding strip. Sized to fit a 7" (2.1 m) high rack with an EIA-310-E Universal hole pattern and 45U, the busbar is punched with a series of holes that align with each mounting hole on the rack. When equipment is mounted to the rack, the rack-mount brackets touch the busbar. Alternately, the Equipment Bonding Jumper Kit can be used to connect equipment to the busbar.

- Each kit includes one ground bar, three #12-24 zinc-plated thread forming hex washer head installation screws, an abrasive pad, joint compound and a ground label
- The ground bar is .05" (1.3 mm) thick tinned copper strip, 78.65" H x .68" W (1997 mm x 17 mm) and is punched with holes that match the EIA-310 Universal Hole Pattern
- UL Listed Ground Bar, File E236184, Category KDER (US), KDER7 (Canada) - Bonding and Grounding Equipment

| Part Number | Description | Shipping Weight lb (kg) |
|-------------|----------------------------------|-------------------------------|
| 40172-001 | Vertical Rack Bonding Busbar Kit | 2 (0.9) |

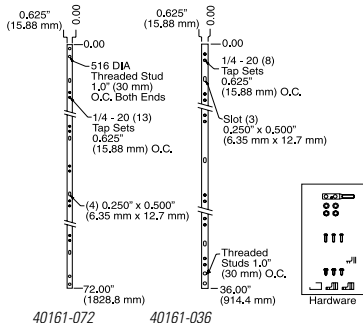

Vertical Rack Bonding Busbar Kits

Vertical Rack Bonding Busbar (RBB) Kits isolate the Busbar from the rack to help control current paths from passing through one piece of equipment to another.

- Other configurations are available on request
- UL Listed, File E236184, Category KDER (US), KDER7 (Canada) - Bonding and Grounding Equipment
- The 36" (910 mm) bar has one set of #5/16 self-clinching studs on 1" (25.4 mm) centers at one end for attachment of a equipment bonding conductor. The 72" (1830 mm) bar has two sets of #5/16 self-clinching studs on 1" (25.4 mm) centers at both ends for attachment of a equipment bonding conductor.

Kit consists of:

- (1) Vertical Rack Bonding Busbar
- (1) #2 AWG two-hole ground compression lug with 3/8" (9.53 mm) holes on 1" (25.4 mm) centers
- (3) white Delrin® insulator blocks
- (3) self-tapping screws
- (3) #12-24 mounting screws
- (2) stainless steel lock washers, 5/16"
- (2) nuts

| Part Number | Description W x D x L in (mm) | Number of Lugs | Shipping Weight lb (kg) |
|-------------|-------------------------------------|-------------------|-------------------------------|
| 40161-036 | 5/8 x 1/4 x 36 (15.88 x 6.4 x 910) | 6 (2.7) | 4 (1.8) |
| 40161-072 | 5/8 x 1/4 x 72 (15.88 x 6.4 x 1830) | 7 (3.2) | 5 (2.3) |

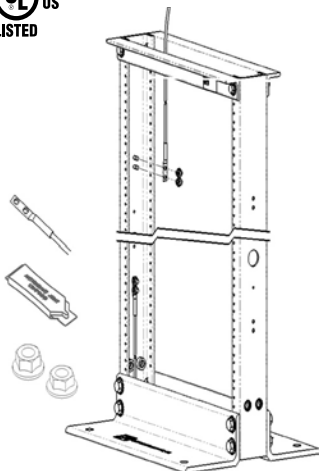

Shown mounted to rack

Rack Bonding Jumper Kit

Rack Bonding Jumper Kits serve as a rack bonding conductor for CPI's Universal and Standard Racks. CPI's Universal Racks include a location for attaching the Rack Bonding Jumper Kit inside the rack's vertical equipment mounting channel. Order additional hardware as required to secure the other end of the jumper to the telecommunications equipment bonding conductor or directly to a telecommunications bonding busbar.

Kit consists of:

- 9' (2.7 m) #6 AWG stranded copper conductor insulated green with a horizontal yellow stripe attached to a two-hole compression lug with 1/4" (6.35 mm) bolt holes spaced on 5/8" (15.88 mm) centers
- 1/4-20 zinc plated serrated flange hex nuts
- 0.5 oz (14 g) packet of aluminum antioxidant joint compound
- Constructed of UL Listed components, File E236184, Category KDER (US), KDER7 (Canada) - Bonding and Grounding Equipment
- Available individually or in packages of 10

| Part Number | Description | Number of Lugs | Shipping Weight lb (kg) |
|-------------|--|-------------------|-------------------------------|
| 40159-008 | Rack Bonding Jumper Kit, 1 Each | 2 (0.9) | 4 (1.8) |
| 40159-018 | Rack Bonding Jumper Kit, Pack of 10 | 12 (5.4) | 5 (2.3) |

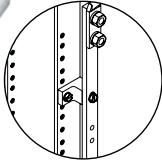

Shown mounted
between rack and
Busbar

Rack Busbar Insulator Block

Rack Busbar Insulator Blocks provide rigid support to physically separate Rack Busbars from all sources of electrical energy. Its offset design securely attaches the Busbar using a #12 self-tapping screw, while allowing unobstructed access to rack-mounted equipment. The Insulator Block has a #12 clearance hole for mounting to the rack.

- Made of durable, nonconductive white Delrin®
- Block measures 3/4" H x 1 1/16" W x 1-1/4" L (19.1 mm x 17.463 mm x 31.8 mm)

| Part Number | Description | Shipping Weight lb (kg) |
|-------------|----------------------------|-------------------------|
| 40157-001 | Insulator Block, Each | 1 (0.5) |
| 40157-050 | Insulator Block, Box of 50 | 2 (0.9) |

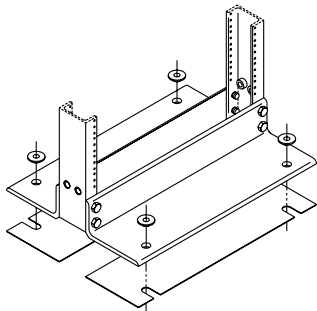

Rack Base Insulator Kit

Rack Base Insulator Kits electrically isolate the racks from the floor for an effective Bonding and Grounding system. Made of .060" (1.52 mm) thick phenolic insulating material and accepts up to 1/2" diameter screws. Used on concrete floors, not needed for access floor applications.

Kit consists of:

- (2) isolation plates
- (4) isolation grommets

| Part Number | Description | Shipping Weight lb (kg) |
|-------------|-------------------------|-------------------------|
| 10605-019 | Insulator Kit, 19" Rack | 3 (1.4) |
| 10605-023 | Insulator Kit, 23" Rack | 3 (1.4) |

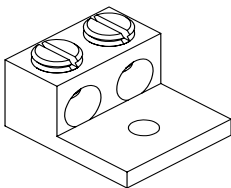

Zinc Plated

One Mounting Hole Bonding Terminal Block

CPI's traditional One Mounting Hole Bonding Terminal Block provides a convenient way to attach ground wires to racks or cabinets using one #12-24 screw (not supplied). Holds up to two #4 gauge wires.

| Part Number | Description | Wire Size | Shipping Weight lb (kg) |
|-------------|----------------------------|-----------|-------------------------|
| 08009-001 | One-Hole Block, Each | Up to #4 | 1 (0.5) |
| 08009-010 | One-Hole Block, Pack of 10 | Up to #4 | 10 (4.5) |

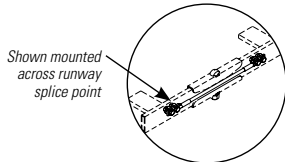
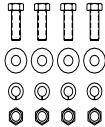
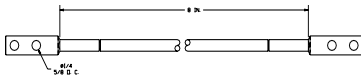

Cable Runway Bonding Strap Kit

Cable Runway Bonding Strap Kits provide a bonding pathway between cable runway lengths when fastened together across splices. Installation requires drilling 5/16" holes. Bonding Straps consist of an 8" L (200 mm) #6 AWG green insulated stranded copper conductor with horizontal yellow stripe attached at both ends to two-hole compression lugs with 1/4" bolt holes spaced on 5/8" (15.88 mm) centers.

- Overall length of 11" (280 mm)
- Available individually or in packages of 25
- Constructed of UL Listed components, File E236184, Category KDER (US), KDER7 (Canada) - Bonding and Grounding Equipment
- Other configurations available on request

Kit consists of:

- (4) stainless steel cap screws, #1/4-20 x 3/4" L
- (4) flat washers, 1/4"
- (4) lock washers, 1/4"
- (4) nuts, 1/4"

| Part Number | Description | Shipping Weight lb (kg) |
|-------------|-----------------------------------|-------------------------|
| 40164-001 | #6 AWG Bonding Strap, Each | 1 (0.5) |
| 40164-025 | #6 AWG Bonding Straps, Pack of 25 | 12 (5.0) |

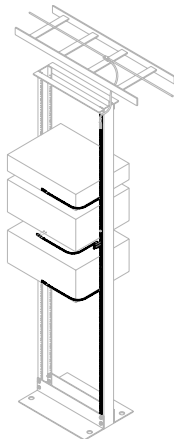
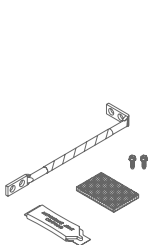

Equipment Bonding Jumper Kit

Use the Equipment Bonding Jumper Kit with the Vertical Rack Busbar Kit to bond rack-mount equipment. The Equipment Bonding Jumper Kit includes a 24" L (710 mm) insulated green/yellow helical stripe #6 AWG bonding conductor with a Slotted Compression Lug on one end and a 90° Slotted Compression Lug on the other end. The 90° Slotted Lug attaches to the busbar, allowing easy alignment with equipment. The Slotted Compression Lug attaches to equipment. The kit includes an abrasive pad, antioxidant joint compound and two installation screws to prepare and secure the jumper to the busbar or ground bar. The installer must provide installation hardware for the lug that attaches to equipment.

- Each kit includes (1) 24" L (710 mm) insulated bonding jumper with attached lugs, (2) plated installation screws, an abrasive pad and joint compound
- The lugs are made from electroplated tinned copper and have (2) mounting holes spaced .5" to .625" apart that accept 1/4" screws
- UL Listed Components, File E236184, Category KDER (US), KDER7 (Canada) - Bonding and Grounding Equipment

| Part Number | Description | Shipping Weight lb (kg) |
|-------------|------------------------------|-------------------------|
| 40159-010 | Equipment Bonding Jumper Kit | 2 (0.9) |



Ground Wire

- Ground Wire is a #6 AWG, 133-strand, green insulated MTW conductor with a yellow helical stripe
- Sold in a 100' (30 m) length on a spool

| Part Number | Description | Shipping Weight lb (kg) |
|-------------|-------------------------------------|-------------------------|
| 40159-001 | Ground Wire, #6 AWG, 100 (30) Spool | 14 (6.4) |



Shown mounted on rack

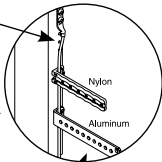

Bonding Jumper

Bonding Jumpers provide common bonding from equipment rack or cabinet to the Telecommunications Equipment Bonding Conductor. Can be used with CPI "L" Brackets (P/N 10001-001 or 10559-500) to attach cable run vertically along equipment rack or cabinet. Bonding jumpers are constructed of a 9'L (2.7 m) #6 AWG stranded copper conductor insulated green with a horizontal yellow stripe attached to a compression lug with two 1/4" bolt holes spaced on 5/8" centers.

- Available individually or in packages of 10
- Constructed of UL Listed components, File E236184, Category KDER (US), KDER7 (Canada) - Bonding and Grounding Equipment
- Other configurations available on request

| Part Number | Description | Shipping Weight lb (kg) |
|-------------|----------------------------------|-------------------------|
| 40159-009 | 9 (2.7) Green Jumper, Each | 2 (0.9) |
| 40159-019 | 9 (2.7) Green Jumper, Pack of 10 | 20 (9.1) |

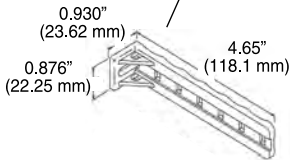

Stand-Off Tie-Down "L" Brackets

These "L" brackets mount to the back of the rack channel to provide a convenient tie-down point for bonding and grounding cable runs. Available in nonconductive nylon or high-strength aluminum construction. Either end of the aluminum bracket can be attached to the rack or cabinet face, allowing cable run in several different ways.

| Part Number | Description | Shipping Weight lb (kg) |
|-------------|--|-------------------------|
| 10001-001 | 1 x 5 (30 x 130) White Nylon, Each | 1 (0.5) |
| 10001-050 | 1 x 5 (30 x 130) White Nylon, Pack of 50 | 3 (1.4) |
| 10559-X00 | 1 x 6 (30 x 150) Aluminum, Each | 1 (0.5) |
| 10559-X50 | 1 x 6 (30 x 150) Aluminum, Pack of 50 | 3 (1.4) |

X=Color: 1=Gray, 2=Computer Beige, 5=Clear, 7=Black, E=Glacier White.

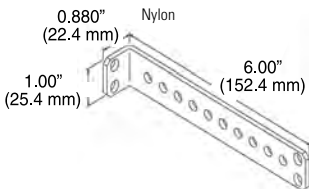

Aluminum

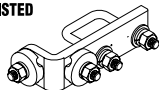

Cross Connector

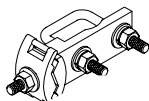
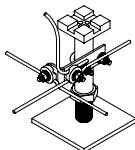

Straight Connector

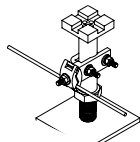

Pedestal Clamp with Bonding Connector

Support bonding conductors from round or square raised floor pedestals using the Pedestal Clamp with Bonding Connector. The connector provides a bonding connection for the pedestal and supports up to four conductors from the pedestal. Use to create a signal reference grid under the raised access floor using #6 AWG or 2/0 bare round conductor.

- Use Cross Connectors to create signal reference grid intersections; support up to (4) conductors, 2 per side, size #6 AWG or 2/0
- Use Straight Connectors to support the signal reference grid in-between intersections; support 1 or 2 conductors on one side of the pedestal only, size #6 AWG or 2/0
- Manufactured from electroplated copper or bronze (P/N 40169-003) with stainless steel installation hardware
- PNs 40169-001 and 40169-002 are UL Listed, File E236184, Category KDER (US),

| Part Number | Description | Pedestal Style, Diameter in (mm) | Number and Size of Connectors | Shipping Weight lb (kg) |
|-------------|------------------------------------|------------------------------------|-------------------------------------|-------------------------|
| 40169-001 | Pedestal Clamp, Cross Connector | Square, 1-1/8 (28) OD | (2) #6 AWG per side | 2 (0.9) |
| 40169-002 | Pedestal Clamp, Cross Connector | Round, 1-1/8 (28) to 1-3/4 (44) OD | (1) #6 AWG and (1) 2/0 per side | 2 (0.9) |
| 40169-003 | Pedestal Clamp, Straight Connector | Square or Round, 1-1/8 (28) OD | (2) #6 AWG or (2) 2/0 one side only | 2 (0.9) |

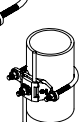
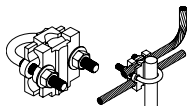

Pipe Clamp with Bonding Connector

Support bonding conductors from metal pipes of various sizes with the Pipe Clamp. The connector provides a bonding connection for the pipe and supports up to two conductors parallel or perpendicular to the pipe. Select the Pipe Clamp with Bonding Connector to match the size of the pipe.

- UL Listed, File E236184, Category KDER (US), KDER7 (Canada) - Grounding and Bonding Equipment
- Supports 1 or 2 conductors; conductors must be the same size
- Use with conductors ranging in size from #6 up to 250 MCM
- Attach conductors parallel or perpendicular to the pipe
- Manufactured from electroplated tinned bronze with stainless steel hardware

| Part Number | Pipe Size / Diameter Ranges | Nominal Size / Outside Diameter | Shipping Weight lb (kg) |
|-------------|-----------------------------|---------------------------------|-------------------------|
| 40170-001 | 5-.75 (10-19) | .375-1 (9.5-30) | 2 (0.9) |
| 40170-002 | 1-1.25 (30-31.8) | .75-1.7 (19-43) | 2 (0.9) |
| 40170-003 | 1.5-2 (38-50) | 1-2.4 (30-61) | 2 (0.9) |
| 40170-004 | 2.5-3 (64-80) | 2.25-3.5 (58-89) | 2 (0.9) |
| 40170-005 | 3.5-4 (89-100) | 3.2-4.5 (81-114) | 2 (0.9) |
| 40170-006 | 5-6 (130-150) | 5.63-6.63 (143-169) | 2 (0.9) |

Note: P/N 40170-001 supports parallel attachment of only one conductor or perpendicular attachment of two conductors. All other clamps support parallel or perpendicular attachment of two conductors. Conductors must be the same size.

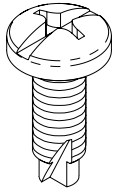

Clean-Thread Screws

The #12-24 Combination Pan Head, Pilot Point Mounting Screws attach equipment to racks and cabinets. A cutting notch in the thread removes paint in threaded holes to improve metal-to-metal contact. The pilot point reduces cross-threading. The combination head can be used with #3 Phillips and slotted screwdrivers.

- Zinc finish
- Available in packages of 50 and 1,000

| Part Number | Description | Unit | Shipping Weight lb (kg) |
|-------------|-----------------------|-------|-------------------------|
| 40605-001 | #12-24 Screws | 50 | 1 (0.5) |
| 40605-004 | #12-24 Screws | 1,000 | 9 (4.1) |
| 40605-005 | #12-24 (Black) Screws | 50 | 1 (0.5) |
| 40605-006 | #12-24 (Black) Screws | 1,000 | 9 (4.1) |

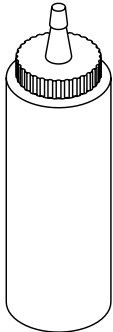

8 oz (230 g)

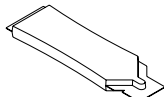

.5 oz (14 g)

Aluminum-To-Aluminum Or Aluminum-To-Copper Antioxidant Joint Compound

Recommended for all aluminum-to-aluminum and aluminum-to-copper connectors, bare conductors, busbars, insulated conductors and conduit threads.

- Zinc finish
- Available in packages of 50 and 1,000

| Part Number | Description | Size | Unit | Shipping Weight lb (kg) |
|-------------|-------------------|---------|------|-------------------------|
| 40166-101 | Antioxidant, Gray | .5 (14) | 1 | 1 (0.5) |
| 40166-801 | Antioxidant, Gray | 8 (230) | 1 | 1 (0.5) |
| 40166-150 | Antioxidant, Gray | .5 (14) | 50 | 2 (0.9) |
| 40166-812 | Antioxidant, Gray | 8 (230) | 12 | 6 (2.7) |

- Oxide inhibiting joint compound is used to improve the electrical conductivity and enhance the integrity of any grounding or bonding connection
- Good for all voltages
- Assures a high-connectivity joint by sealing out air and moisture to prevent corrosion and reformation of oxide film
- Also used as an anti-seizing thread lubricant and ensures continuity of ground on aluminum conduit threads
- Bulk packaging quantities available

Copper-To-Copper Joint Compound

Recommended for all copper-to-copper connections, copper threads and all mechanical/pressure type bonding and grounding connections.

| Part Number | Description | Size | Unit | Shipping Weight lb (kg) |
|-------------|---------------------|-------|------|-------------------------|
| 40168-101 | Antioxidant, Copper | .5 oz | 1 | 1 (0.5) |
| 40168-801 | Antioxidant, Copper | 8 oz | 1 | 1 (0.5) |
| 40168-150 | Antioxidant, Copper | .5 oz | 50 | 2 (0.9) |
| 40168-812 | Antioxidant, Copper | 8 oz | 12 | 6 (2.7) |



Compression Tool

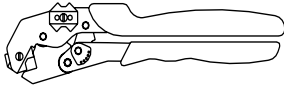

Crimp Tool

Mechanical Compression Tools

Mechanical Compression Tools are used to attach compression lugs and butt splices (not recommended for use with C-Tap connections). The tools feature long steel handles with comfortable rubber grips. The Dieless Compression Tool works with either copper or aluminum conductors. The Crimp Tool comes complete with dies and features extra-long handles for two-handed crimping.

| Part Number | Description | Size | Unit | Shipping Weight lb (kg) |
|-------------|---------------------------|--------------------------------------|------------|-------------------------|
| 40165-001 | Compression Tool, Dieless | Copper #8-250 MCS Aluminum #8-4/0 | 24 (610) | 5 (2.3) |
| 40165-002 | Crimp Tool | #8-1/0 | 10.5 (267) | 3 (1.4) |



Compression Lugs

Connect copper or tinned copper conductors to Busbars, racks, cabinets or Cable Runway. Manufactured from electroplated tinned copper conductors

- Available individually or in bulk quantities in 3 styles; Two-Hole, Slotted and 90° Slotted

| Part Number | Description | Cable Size | Hole Spacing in (mm) | Hole Size in (mm) | Color Code | Quantity | Shipping Weight lb (kg) |
|-------------|-----------------|------------|-------------------------|-------------------|------------|----------|-------------------------|
| 40162-901 | Two-Hole Lug | #6 | .625 (15.9) | .250 (6.4) | Blue | 1 | 1 (0.5) |
| 40162-951 | Two-Hole Lug | #6 | .625 (15.9) | .250 (6.4) | Blue | 50 | 2 (0.9) |
| 40162-902 | Two-Hole Lug | #6 | .750 (19.1) | .375 (9.5) | Blue | 1 | 1 (0.5) |
| 40162-952 | Two-Hole Lug | #6 | .750 (19.1) | .375 (9.5) | Blue | 50 | 2 (0.9) |
| 40162-903 | Two-Hole Lug | #6 | 1.00 (25.4) | .375 (9.5) | Blue | 1 | 1 (0.5) |
| 40162-953 | Two-Hole Lug | #6 | 1.00 (25.4) | .375 (9.5) | Blue | 50 | 2 (0.9) |
| 40162-904 | Two-Hole Lug | #2 | .625 (15.9) | .250 (6.4) | Brown | 1 | 1 (0.5) |
| 40162-954 | Two-Hole Lug | #2 | .625 (15.9) | .250 (6.4) | Brown | 25 | 2 (0.9) |
| 40162-905 | Two-Hole Lug | #2 | .750 (19.1) | .375 (9.5) | Brown | 1 | 1 (0.5) |
| 40162-955 | Two-Hole Lug | #2 | .750 (19.1) | .375 (9.5) | Brown | 25 | 2 (0.9) |
| 40162-907 | Two-Hole Lug | #2 | 1.00 (25.4) | .375 (9.5) | Brown | 1 | 1 (0.5) |
| 40162-957 | Two-Hole Lug | #2 | 1.00 (25.4) | .375 (9.5) | Brown | 25 | 2 (0.9) |
| 40162-909 | Two-Hole Lug | 2/0 | 1.00 (25.4) | .375 (9.5) | Black | 1 | 1 (0.5) |
| 40162-959 | Two-Hole Lug | 2/0 | 1.00 (25.4) | .375 (9.5) | Black | 10 | 2 (0.9) |
| 40162-910 | Two-Hole Lug | 2/0 | 1.75 (44.5) | .500 (12.7) | Black | 1 | 2 (0.9) |
| 40162-960 | Two-Hole Lug | 2/0 | 1.75 (44.5) | .500 (12.7) | Black | 10 | 2 (0.9) |
| 40162-911 | Two-Hole Lug | 4/0 | 1.00 (25.4) | .375 (9.5) | Purple | 1 | 1 (0.5) |
| 40162-961 | Two-Hole Lug | 4/0 | 1.00 (25.4) | .375 (9.5) | Purple | 10 | 2 (0.9) |
| 40162-912 | Two-Hole Lug | 4/0 | 1.75 (44.5) | .500 (12.7) | Purple | 1 | 1 (0.5) |
| 40162-962 | Two-Hole Lug | 4/0 | 1.75 (44.5) | .500 (12.7) | Purple | 10 | 3 (1.4) |
| 40162-913 | Slotted Lug | #6 | .500 (12.7)/.625 (15.9) | .250 (6.4) | Blue | 1 | 1 (0.5) |
| 40162-963 | Slotted Lug | #6 | .500 (12.7)/.625 (15.9) | .250 (6.4) | Blue | 25 | 2 (0.9) |
| 40162-914 | 90° Slotted Lug | #6 | .500 (12.7)/.625 (15.9) | .250 (6.4) | Blue | 1 | 1 (0.5) |
| 40162-964 | 90° Slotted Lug | #6 | .500 (12.7)/.625 (15.9) | .250 (6.4) | Blue | 25 | 2 (0.9) |

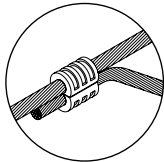
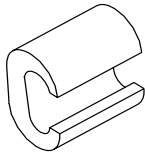

Shown connecting two copper conductors

C-Type Compression Taps

C-Type Compression Taps connect two copper conductors with the use of a hydraulic crimping tool.

- Available individually or in bulk packages
- Other sizes available on request
- UL Listed

| Part Number | Description | Hole Spacing in (mm) | Hole Size in (mm) | Shipping Weight lb (kg) |
|-------------|------------------------|------------------------|-------------------|-------------------------|
| 40163-004 | #2 Stranded #2 Solid | #2 Stranded #2 Solid | 1 | 1 (0.5) |
| 40163-054 | #2 Stranded #2 Solid | #2 Stranded #2 Solid | 50 | 4 (1.8) |
| 40163-003 | #2 Stranded #2 Solid | #4 Stranded #8 Solid | 1 | 1 (0.5) |
| 40163-053 | #2 Stranded #2 Solid | #4 Stranded #8 Solid | 50 | 6 (2.7) |
| 40163-002 | #4 Stranded #4 Solid | #4 Stranded #6 Solid | 1 | 1 (0.5) |
| 40163-052 | #4 Stranded #4 Solid | #4 Stranded #6 Solid | 50 | 3 (1.4) |
| 40163-001 | #4 Stranded #6 Solid | #6 Stranded #6 Solid | 1 | 1 (0.5) |
| 40163-051 | #4 Stranded #6 Solid | #6 Stranded #6 Solid | 50 | 3 (1.4) |
| 40163-005 | 2/0 Stranded 1/0 Solid | #2 Stranded #8 Solid | 1 | 1 (0.5) |
| 40163-055 | 2/0 Stranded 1/0 Solid | #2 Stranded #8 Solid | 10 | 1 (0.5) |
| 40163-007 | 2/0 Stranded 1/0 Solid | 2/0 Stranded 1/0 Solid | 1 | 1 (0.5) |
| 40163-057 | 2/0 Stranded 1/0 Solid | 2/0 Stranded 1/0 Solid | 10 | 1 (0.5) |
| 40163-006 | 4/0 Stranded 3/0 Solid | #2 Stranded #6 Solid | 1 | 1 (0.5) |
| 40163-056 | 4/0 Stranded 3/0 Solid | #2 Stranded #6 Solid | 10 | 1 (0.5) |
| 40163-008 | 4/0 Stranded 3/0 Solid | 2/0 Stranded 1/0 Solid | 1 | 1 (0.5) |
| 40163-058 | 4/0 Stranded 3/0 Solid | 2/0 Stranded 1/0 Solid | 10 | 2 (0.9) |
| 40163-009 | 4/0 Stranded 3/0 Solid | 4/0 Stranded 3/0 Solid | 1 | 1 (0.5) |
| 40163-059 | 4/0 Stranded 3/0 Solid | 4/0 Stranded 3/0 Solid | 10 | 2 (0.9) |



SECTION 6

INDUSTRIAL ENCLOSURE SYSTEMS

| | | | |
|--|------|---|------|
| RMR® Modular Enclosure | 6-3 | RMR Flange-Mount, Disconnect, Free-Standing Enclosure | 6-34 |
| RMR Swing Wall-Mount Enclosure | 6-12 | RMR Flange-Mount, Disconnect, Standard Wall-Mount Enclosure..... | 6-36 |
| RMR Fixed Wall-Mount Enclosure..... | 6-14 | RMR Accessories | 6-38 |
| RMR Floor-Mount Enclosure..... | 6-20 | Thermal Management Accessories | 6-40 |
| RMR Free-Standing Enclosure | 6-23 | RMR Enclosure Sealing Systems | 6-43 |
| RMR Standard Wall-Mount..... | 6-28 | RMR Cellular Wireless Enclosures | 6-44 |
| RMR Flange-Mount, Disconnect, Floor-Mount Enclosure | 6-32 | | |

Learn about CPI's Extended Limited Warranties for coverage of (2) additional years beyond the expiration of the Standard Limited Warranty Period. See page vi.

INDUSTRIAL ENCLOSURE SYSTEMS

Section Update:

- RMR® Enclosures, New Stainless Steel Option:
 - RMR Floor-Mount Enclosures Page 6-20
 - RMR Free-Standing Enclosures Page 6-23
 - RMR Standard Wall-Mount Enclosures Page 6-28
- RMR Flange-Mount, Disconnect, Floor-Mount Enclosures Page 6-32
- RMR Flange-Mount, Disconnect, Free-Standing Enclosures Page 6-34
- RMR Flange-Mount, Disconnect, Wall-Mount Enclosures Page 6-36
- RMR Cellular Wireless Enclosures Page 6-44

Where Can I Learn More?

To learn more about CPI's Industrial Enclosure Systems, or to find additional part numbers not listed in this catalog, please visit our website, chatsworth.com

Related Tools:

Use these tools, under the Resources tab on chatsworth.com, to simplify your planning, selection, order and purchase of CPI Industrial Enclosure Systems.

- Product Designer



CPI Product Designer creates unique industrial enclosures quickly and easily by allowing you to select the size, features and accessories needed for a specific application. Access this tool at chatsworth.com/product-designer.

Your Notes Here:



RMR Stainless Steel & Disconnect Enclosures



RMR Modular Enclosure

RMR Modular Enclosure is an advanced Industrial Distribution Frame (IDF)/ Factory Edge enclosure engineered to protect equipment with cutting-edge sealing technology, certified ingress protection ratings, and multiple equipment mounting options to support IT equipment, automation electronics and electrical controls and instrumentation in nonhazardous indoor locations.

The RMR Modular Enclosure features a welded, roll-formed frame that is punched with attachment points on all interior surfaces to support an array of panel and equipment installations. The frame may be outfitted with a variety of mounting plates or 19" EIA (482.6 mm) wide equipment rails. Mounting plates are available in quarter-, half- and full-height options.

- Provides equipment with NEMA Type 12 and IP 55 rated protection against ingress of solid foreign objects and dripping noncorrosive liquids, using advanced formed-in-place foam gasket technology at each panel and cable entry point
- Supports airflow and cooling options specially certified for industrial applications to maintain equipment cooling requirements outside of normal IT settings and equipment rooms
- Features unique drop-in frame attachment hardware, allowing quick and secure mounting of plates, rails and accessories at any point along the frame
- Allows a complete enclosure solution to be configured under a single part number, including the exact size frame, mounting system, doors, panel work and ventilation that you require
- Offers short lead times for modified enclosures—change size or color, and add openings for connections, controls and HMI

Cabinet Includes:

- (1) Modular enclosure frame
- (4) Equipment mounting rails or (1) equipment mounting plate
- (1) Top Panel
- (2) Side Panels
- (1) Front Door
- (1) Rear Door or Fixed Rear Panel
- (1) Bottom Panel
- Optional Filter Fan or Cooling Unit

Cabinet Specifications:

- Heights:
 - 24U, 47.2" (1200 mm)
 - 42U, 78.7" (2000 mm)
 - 45U, 82.7" (2100 mm)
 - 47U, 86.6" (2200 mm)
- Widths: 23.6" (600 mm) and 31.5" (800 mm)
- Depths: 23.6" (600 mm), 31.5" (800 mm), 39.4" (1000 mm) and 47.2" (1200 mm)
- Equipment Space 19" EIA (482.6 mm) Equipment Mounting Rails (2 pairs) or (1) Full-Height Rear Mounting
- Frame:
 - Welded, roll-formed steel frame; modular construction
 - Punched with attachment pattern, 0.98" (25 mm) increments
 - Drop-in attachment hardware provides quick, secure, bonded accessory

Certifications:

- NEMA Type 12 and IEC 60529, IP 55

All Enclosures are:

- UL Listed, Industrial Control Panel Enclosures, Type 12, File Number NITW.E473128
- UL Listed, Industrial Control Panel Enclosures for Canada, Type 12, File NITW7. E473128

Enclosures without filter fans or air conditioners are:

- UL Classified, Degrees of Protection by Enclosures Certified to IEC Publication, EOFI.E486325
- RoHS, REACH

Use the part number matrix below to configure a RMR Modular Enclosure. Choose the **Height**, **Width**, **Depth**, **FR**ame Style, **FR**ont Door, **RE**ar Door, **Side Panel**, **L**atch, **C**olor, **B**ottom Panel and **T**op Panel. **Example Cabinet Part Number: A1-11AA-1121-G11.**

| A | 1 | - | H | W | D | FR | - | FD | RD | SP | L | - | C | BP | TP |
|--|-----------|-----------|----------|---|---|----|---|----|----|----|---|---|---|----------|----|
| 1. Type | | | | | | | | | | | | | | | |
| Modular | | 1 | | | | | | | | | | | | | |
| 2. Height | | | | | | | | | | | | | | | |
| U | in | mm | | | | | | | | | | | | | |
| 24 | 47.2 | 1200 | 1 | | | | | | | | | | | | |
| 42 | 78.7 | 2000 | 2 | | | | | | | | | | | | |
| 45 | 82.7 | 2100 | 3 | | | | | | | | | | | | |
| 47 | 86.6 | 2200 | 4 | | | | | | | | | | | | |
| 3. Width | | | | | | | | | | | | | | | |
| in | mm | | | | | | | | | | | | | | |
| 23.6 | 600 | 1 | | | | | | | | | | | | | |
| 31.5 | 800 | 2 | | | | | | | | | | | | | |
| 4. Depth | | | | | | | | | | | | | | | |
| in | mm | | | | | | | | | | | | | | |
| 23.6 | 600 | A | | | | | | | | | | | | | |
| 31.5 | 800 | B | | | | | | | | | | | | | |
| 39.4 | 1000 | C | | | | | | | | | | | | | |
| 47.2 | 1200 | D | | | | | | | | | | | | | |
| 5. Frame Style | | | | | | | | | | | | | | | |
| Multi-Mount (Square-Punched) Rails, 2 Pair, 19" EIA (482.6 mm) | | | | | | | | | | | | | | A | |
| Multi-Mount (Square-Punched) Rails, 2 Pair, 19" EIA (482.6 mm) with Front-To-Rear Horizontal Support Slides | | | | | | | | | | | | | | B | |
| Full-Height Mounting Plate Assembly with Lower Support Rails | | | | | | | | | | | | | | C | |
| 6. Front Door | | | | | | | | | | | | | | | |
| Single Solid Metal Door | | | | | | | | | | | | | | 1 | |
| Single Metal Door with Window | | | | | | | | | | | | | | 2 | |
| Intake Door Assembly with Filter Fan, 7" (177 mm), 65 CFM (110 CMH), 115 VAC | | | | | | | | | | | | | | 3 | |
| Intake Door Assembly with Filter, 7" (177 mm) | | | | | | | | | | | | | | 4 | |
| Intake Door Assembly with Filter Fan, 11.5" (291 mm), 560 CFM (351 CMH), 115 VAC | | | | | | | | | | | | | | 5 | |
| Intake Door Assembly with Filter, 11.5" (291 mm) | | | | | | | | | | | | | | 6 | |
| Intake Door Assembly with Filter Fan, 7" (177 mm), 65 CFM (110 CMH), 230 VAC | | | | | | | | | | | | | | 7 | |
| Intake Door Assembly with Filter Fan, 11.5" (291 mm), 560 CFM (951 CMH), 230 VAC | | | | | | | | | | | | | | 8 | |
| AC Door Assembly with Cooling Unit, 3000-4000 Btu/hr (879-1172 W), 115 VAC | | | | | | | | | | | | | | 9 | |
| 7. Rear Door | | | | | | | | | | | | | | | |
| Single-Sided Metal Door | | | | | | | | | | | | | | 1 | |
| Fixed Rear Metal Panel (no hinges, no latch) | | | | | | | | | | | | | | 2 | |
| Exhaust Door Assembly with Filter Fan, 7" (177 mm), 65 CFM (110 CMH), 115 VAC | | | | | | | | | | | | | | 3 | |
| Exhaust Door Assembly with Filter Fan, 11.5" (291 mm), 560 CFM (951 CMH), 115 VAC | | | | | | | | | | | | | | 4 | |
| Exhaust Door Assembly with Filter Fan, 7" (177 mm), 65 CFM (110 CMH), 230 VAC | | | | | | | | | | | | | | 5 | |
| Exhaust Door Assembly with Filter Fan, 11.5" (291 mm), 560 CFM (951 CMH), 230 VAC | | | | | | | | | | | | | | 6 | |
| Exhaust Door Assembly with Filter, 7" (177 mm) | | | | | | | | | | | | | | 7 | |
| Exhaust Door Assembly with Filter, 11.5" (291 mm) | | | | | | | | | | | | | | 8 | |
| 8. Side Panels | | | | | | | | | | | | | | | |
| None | | | | | | | | | | | | | | 0 | |
| Single Solid Side Panel Assembly, (Qty. 1) | | | | | | | | | | | | | | 1 | |
| Single Metal Side Panel Assembly, (Qty. 2) | | | | | | | | | | | | | | 2 | |
| Intake Side Panel Assembly with Filter Fan, 7" (177 mm), 65 CFM (110 CMH), 115 VAC; Right. Exhaust Side Panel Assembly with Filter, 7" (177 mm); Left | | | | | | | | | | | | | | 3 | |
| Intake Side Panel Assembly with Filter Fan, 11.5" (291 mm), 560 CFM (951 CMH), 115 VAC; Right. Exhaust Side Panel Assembly with Filter, 11.5" (291 mm); Left | | | | | | | | | | | | | | 4 | |
| Intake Side Panel Assembly with Filter Fan, 7" (177 mm), 65 CFM (110 CMH), 230 VAC; Right. Exhaust Side Panel Assembly with Filter, 7" (177 mm); Left | | | | | | | | | | | | | | 5 | |
| Intake Side Panel Assembly with Filter Fan, 11.5" (291 mm), 560 CFM (951 CMH), 230 VAC; Right. Exhaust Side Panel Assembly with Filter, 11.5" (291 mm); Left | | | | | | | | | | | | | | 6 | |
| AC Side Panel Assembly with Cooling Unit, 5000-7000 Btu/hr (1465-2051 W), 115 VAC; Right. Single Metal Side Panel Assembly; Left | | | | | | | | | | | | | | 7 | |
| Intake Side Panel Assembly with Filter, 11.5" (291 mm); Right. Intake Side Panel Assembly with Filter, 11.5" (291 mm); Left, Use with Top Panel Fan | | | | | | | | | | | | | | 8 | |
| 9. Latch | | | | | | | | | | | | | | | |
| Double Bit Latch Assembly | | | | | | | | | | | | | | 1 | |
| T Handle Latch Assembly with CH751 Keyed Lock | | | | | | | | | | | | | | 2 | |
| 10. Color | | | | | | | | | | | | | | | |
| Black | | | | | | | | | | | | | | C | |
| Hammer Gray RAL 7035 | | | | | | | | | | | | | | G | |
| 11. Bottom Panel | | | | | | | | | | | | | | | |
| Solid Bottom | | | | | | | | | | | | | | 1 | |
| With Removable Gland Plates | | | | | | | | | | | | | | 2 | |
| 12. Top Panel | | | | | | | | | | | | | | | |
| Solid Metal Panel | | | | | | | | | | | | | | 1 | |
| Gland Panel | | | | | | | | | | | | | | 2 | |
| Exhaust Panel with Filter Fan 11.5" (291 mm), 441 CFM (749 CHM), 115 VAC | | | | | | | | | | | | | | 3 | |

Specifications/Ordering Notes:

1. Height, Widths, Depths: See tables below for detailed dimensions.
6. Front Doors: Intake Filter Fans and Intake Filters are located on the bottom half of the door, Cooling Unit is centered on the door. When using fans, there should be one intake and one exhaust of the same size. Recommended configuration is intake filter fan and exhaust filter. If Intake Door Assembly is selected for the Front Door, select an Exhaust Door Assembly for the Rear Door with the same size Filter or Filter Fan. If AC Door Assembly is selected, select a Solid Metal Door or a Fixed Rear Metal Panel for the Rear Door and Metal Side Panel Assemblies.
7. Rear Doors: Exhaust Filter Fans and Filters are located on the top half of the door. When using fans, there should be one intake and one exhaust of the same size. Recommended configuration is intake filter fan and exhaust filter. If an Exhaust Door Assembly is selected for the Rear Door, select an Intake Door Assembly for the Front Door with the same size filter or filter fan.
8. Side Panels: Omit Side Panels when buying cabinets. Use Side Panel Assemblies with Filter Fans or Cooling Units with solid front and rear doors. Use Side Panel Assembly with Filters only with Top Panel Fan Kit.

For the full line of enclosure configurations, use the RMR Product Designer at chatsworth.com/product-designer.

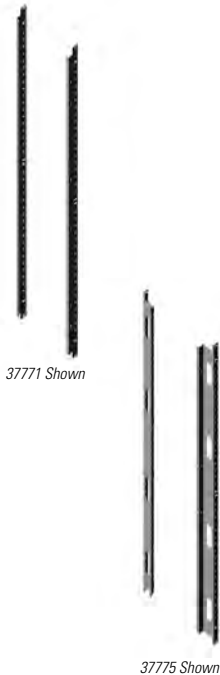

Equipment Mounting Rails

Equipment Mounting Rails attach directly to frame of the enclosure or to optional front-to-rear horizontal support slides, and support 19" EIA (482.6 mm) rack-mount equipment. Equipment Mounting Rails can be ordered with the enclosure.

- Adjustable-depth, support 19" EIA (482.6 mm) rack-mount equipment
- Universal (vertical) hole pattern, 1U are 1.75"H (44.45 mm)
- U are marked and numbered on the mounting rail
- 12-24 tapped for screws or multi-mount (square-punched) for cage nuts
- Electrically bonded to the enclosure frame
- Optional Front-to-Rear Horizontal Slides available (includes six slides)

| Multi-Mount (Square Punched) Rails for RMR Modular Enclosure | | | | |
|--|------------|--------------------------------|--------------------------|-------------------------------|
| Part Number Width - in (mm) | | Enclosure Height in (mm) | Rack-Mount Spaces (U) | Shipping Weight lb (kg) |
| 23.6 (600) | 31.5 (800) | | | |
| 37771-X01 | 37772-X01 | 47.2 (1200) | 24 | 19 (8.7) |
| 37771-X03 | 37772-X03 | 78.7 (2000) | 42 | 30 (13.7) |
| 37771-X04 | 37772-X04 | 82.7 (2100) | 45 | 31 (14.1) |
| 37771-X05 | 37772-X05 | 86.6 (2200) | 47 | 33 (15.0) |

| Tapped #12-24 Equipment Rails for RMR Modular Enclosure | | | | |
|---|------------|--------------------------------|--------------------------|-------------------------------|
| Part Number Width - in (mm) | | Enclosure Height in (mm) | Rack-Mount Spaces (U) | Shipping Weight lb (kg) |
| 23.6 (600) | 31.5 (800) | | | |
| 37774-X01 | 37775-X01 | 47.2 (1200) | 24 | 20 (9.1) |
| 37774-X03 | 37775-X03 | 78.7 (2000) | 42 | 31 (14.1) |
| 37774-X04 | 37775-X04 | 82.7 (2100) | 45 | 32 (14.6) |
| 37774-X05 | 37775-X05 | 86.6 (2200) | 47 | 33 (15.0) |

X=Color: C=Black, G=Hammer Gray. Shipping weight is for 800 mm wide models.

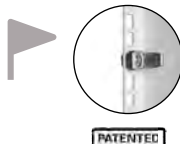

*Clik-Nut® cage nuts make installation time quick and easy.
Go to page 1-38 for ordering information.*

Enclosure Plinth Base

Plinth Base is a structural steel mounting base that creates a lift, which can be used to service and route cables through the bottom panel of the enclosure.

- 4" H (100 mm) or 8" H (200 mm) lift options
- Features kick plates that surround the base of the enclosure
- Includes: Metal structure and assembly hardware



| Part Number Plinth Height - in (mm) | | Width in (mm) | Depth in (mm) | Shipping Weight lb (kg) |
|--|-----------|------------------|------------------|-------------------------------|
| 4 (100) | 8 (200) | | | |
| 37830-X03 | 37830-X21 | 23.6 (600) | 23.6 (600) | 40 (18.2) |
| 37830-X05 | 37830-X23 | 23.6 (600) | 31.5 (800) | 44 (20.0) |
| 37830-X07 | 37830-X25 | 23.6 (600) | 39.4 (1000) | 48 (21.8) |
| 37830-X09 | 37830-X27 | 23.6 (600) | 47.2 (1200) | 52 (23.6) |
| 37830-X12 | 37830-X30 | 31.5 (800) | 23.6 (600) | 44 (20.0) |
| 37830-X14 | 37830-X32 | 31.5 (800) | 31.5 (800) | 48 (21.8) |
| 37830-X16 | 37830-X34 | 31.5 (800) | 39.4 (1000) | 52 (23.6) |
| 37830-X18 | 37830-X36 | 31.5 (800) | 47.2 (1200) | 56 (25.5) |

X=color: C=Black, G=Hammer Gray. Shipping weights are for 8" (200 mm) plinth height.

Cable Lashing Bracket

Cable Lashing Bracket creates a simple, separate vertical pathway for a small bundle of cables and has multiple slots for straps or tie wraps to secure cables to the bracket.

- Attaches to the frame, adjusts in depth independent of the mounting rails
- Bracket is 1.6"W (41 mm)
- Includes: Brackets, installation hardware; order cable ties separately

| Part Number | Description | Shipping Weight lb (kg) |
|-------------|-------------|----------------------------|
| 37800-X01 | 47.2 (1200) | 7 (3.2) |
| 37800-X03 | 78.7 (2000) | 9 (4.1) |
| 37800-X04 | 82.7 (2100) | 9 (4.1) |
| 37800-X05 | 86.6 (2200) | 9 (4.1) |

X=color: C=Black, G=Hammer Gray.



Finger Cable Manager

Finger Cable Manager is a T-shaped cable guide that creates a pathway for cables next to the 19" EIA (482.6 mm) equipment mounting rails and guides cables into each U space. Wider configurations for 31.5"W (800 mm) enclosures also feature a protective cover.

- Attaches to and adjusts with mounting rails
- Passes up to 24 cables per U space through openings on Short Finger Cable Manager
- Hinged cover on wider configurations, 31.5"W (800 mm) enclosures, snaps closed to secure cables
- Includes: Finger Cable Manager, cover (on wider managers) and installation hardware



37850 Shown



37860 Shown

| Short Finger Cable Manager (for use on 19" EIA Rails) | | | | |
|---|------------|--------------------------|----------------------|-------------------------|
| Part Number Width - in (mm) | | Enclosure Height in (mm) | Rack-Mount Space (U) | Shipping Weight lb (kg) |
| 23.6 (600) | 31.5 (800) | | | |
| 37850-X01 | 37860-X01 | 47.2 (1200) | 24 | 14 (6.4) |
| 37850-X03 | 37860-X03 | 78.7 (2000) | 42 | 16 (7.3) |
| 37850-X04 | 37860-X04 | 82.7 (2100) | 45 | 21 (9.6) |
| 37850-X05 | 37860-X05 | 86.6 (2200) | 47 | 22 (10.0) |

| Short Finger Cable Manager (for use on 19" EIA Rails with Horizontal Support Slides) | | | | |
|--|------------|--------------------------|----------------------|-------------------------|
| Part Number Width - in (mm) | | Enclosure Height in (mm) | Rack-Mount Space (U) | Shipping Weight lb (kg) |
| 23.6 (600) | 31.5 (800) | | | |
| 37865-X01 | 37860-X01 | 47.2 (1200) | 24 | 8 (3.7) |
| 37865-X03 | 37860-X03 | 78.7 (2000) | 42 | 10 (4.6) |
| 37865-X04 | 37860-X04 | 82.7 (2100) | 45 | 11 (5.0) |
| 37865-X05 | 37860-X05 | 86.6 (2200) | 47 | 11 (5.0) |

X= Color; C=Black, G=Hammer Gray. Shipping weights are for 800 mm wide enclosures. P/N 3780-XXX can be used with Horizontal Support Slides.

Dual PDU Bracket

Full-Height Dual PDU Mounting Bracket supports two vertical PDUs side-by-side and has multiple slots for CPI Saf-T-Grip Straps or tie wraps to secure cords to the bracket.

- Attaches to the frame, adjusts in depth independent of the mounting rails
- Dual bracket is 4.8"W (121 mm) and supports (2) PDUs up to 2.2"W (51 mm) side-by-side
- Includes: Brackets, installation hardware

| Part Number | Description | Shipping Weight lb (kg) |
|-------------|-----------------------------------|-------------------------|
| 37808-X03 | Full-Height, for 78.7"H (2000 mm) | 12 (5.5) |
| 37808-X04 | Full-Height, for 82.7"H (2100 mm) | 13 (5.9) |
| 37808-X05 | Full-Height, for 86.6"H (2200 mm) | 13 (5.9) |
| 37809-X01 | Half-Height, for 47.2"H (1200 mm) | 10 (4.6) |

X=color; C=Black, G=Hammer Gray.

Ring Cable Manager

Ring Cable Manager is a ring-shaped cable guide that creates a separate vertical pathway for cables, independent of the equipment mounting rails.

- Attaches to the frame, adjusts in depth independent of the mounting rails
- Rings have an opening on the front for easy addition or removal of cables
- Includes: Brackets, rings and installation hardware
- Material: Steel brackets, plastic rings

| Part Number | Enclosure Height in (mm) | Plate Width in (mm) | Shipping Weight lb (kg) |
|-------------|--------------------------|---------------------|-------------------------|
| 37801-X01 | 37802-X01 | 47.2 (1200) | 11 (5.0) |
| 37801-X03 | 37802-X03 | 78.7 (2000) | 14 (6.4) |
| 37801-X04 | 37802-X04 | 82.7 (2100) | 14 (6.4) |
| 37801-X05 | 37802-X05 | 86.6 (2200) | 14 (6.4) |

X=Color, C=Black, G=Hammer Gray. Shipping weights are for 800 mm wide.

Short Ring Cable Manager

Short Ring Cable Manager includes a set of four 7U high brackets that create a pathway for cables next to the 19" EIA (482.6 mm) equipment mounting rails.

- Attaches to and adjusts with mounting rails
- Brackets have slots for securing cable bundles with Saf-T-Grips or tie wraps
- Rings have an opening on the front for easy addition or removal of cables
- Includes: Brackets, rings and installation hardware

| Part Number | Shipping Weight lb (kg) |
|-------------|-------------------------|
| 37803-X01 | 10 (4.6) |

X=Color, C=Black, G=Hammer Gray.

Quarter-Height Mounting Plate

Quarter-Height Mounting Plates are solid metal panels that can be mounted in multiple orientations—front-to-rear or side-to-side—directly to the uprights of the frame. The 23.6"W (600 mm) plates can also be mounted directly to 19" EIA square-punched or threaded rails.

| Part Numbers | | | | Plate Size Height in (mm) | Plate Size Width in (mm) | |
|------------------------------------|------------|-------------|-------------|---------------------------|--------------------------|-------------|
| Enclosure Depth or Width - in (mm) | | | | | | |
| 23.6 (600) | 31.5 (800) | 39.4 (1000) | 47.2 (1200) | Height in (mm) | | |
| 37842-X14 | 37842-X26 | 37842-X38 | 37842-X50 | | | 70.9 (1800) |
| 37842-X15 | 37842-X27 | 37842-X39 | 37842-X51 | 78.7 (2000) | 18.5 (470) | * |
| 37842-X16 | 37842-X28 | 37842-X40 | 37842-X52 | 82.7 (2100) | 19.4 (493) | * |
| 37842-X17 | 37842-X29 | 37842-X41 | 37842-X53 | 86.6 (2200) | 20.4 (519) | * |

*Calculate plate width by subtracting approximately 3.0" (75 mm) from enclosure depth or width; for example, the plate size width for a 23.6"W (600 mm) enclosure is approximately 20.6"W (525 mm). *Shipping weights vary by part number: 18 to 73 lb (8.2 to 33.2 kg).

X=Color, C=Black, G=Hammer Gray.



Half-Height Mounting Plate

Half-Height Mounting Plates are solid metal panels that can be mounted in multiple orientations—front-to-rear or side-to-side—directly to the uprights of the frame. The 23.6" W (600 mm) plates can also be mounted directly to 19" EIA square punched or threaded rails.

| Part Numbers | | | | Height in (mm) | Plate Size Height in (mm) | Plate Size Width in (mm) |
|------------------------------------|---------------|----------------|----------------|-------------------|------------------------------------|-----------------------------------|
| Enclosure Depth or Width - in (mm) | | | | | | |
| 23.6 (600) | 31.5 (800) | 39.4 (1000) | 47.2 (1200) | | | |
| 37840-X13 | 37840-X25 | 37840-X37 | 37840-X49 | 47.2 (1200) | 31.1 (536) | * |
| 37840-X15 | 37840-X27 | 37840-X39 | 37840-X51 | 78.7 (2000) | 78.4 (1992) | * |
| 37840-X16 | 37840-X28 | 37840-X40 | 37840-X52 | 82.7 (2100) | 82.3 (2091) | * |
| 37840-X17 | 37840-X29 | 37840-X41 | 37840-X53 | 86.6 (2200) | 86.3 (2193) | * |

*Calculate plate size width by subtracting approximately 3.0" (75 mm) from enclosure depth or width; for example, the plate size width for a 23.6" W (600 mm) enclosure is approximately 20.6" W (525 mm). *Shipping weights vary by part number: 18 to 73 lb (8.2 to 33.2 kg).

X=Color; C=Black, G=Hammer Gray.



Full-Height Mounting Plate Assembly

Full-Height Mounting Plates are solid metal panels that are installed in a side-to-side orientation of the enclosure frame. Mounting panels can be adjusted in depth by 1" (25 mm) increments. Full-Height Mounting Plate Assembly with Lower Support Rails can be ordered with the enclosure.

| Part Numbers for 23.6" W (600 mm) Enclosures | | | | Height in (mm) | Plate Size Height in (mm) | Plate Size Width in (mm) |
|--|------------|-------------|-------------|-------------------|------------------------------------|-----------------------------------|
| Enclosure Depth - in (mm) | | | | | | |
| 23.6 (600) | 31.5 (800) | 39.4 (1000) | 47.2 (1200) | | | |
| 37780-X13 | 37780-X25 | 37780-X37 | 37780-X49 | 47.2 (1200) | 46.9 (1192) | 22.9 (582) |
| 37780-X15 | 37780-X27 | 37780-X39 | 37780-X51 | 78.7 (2000) | 77.4 (1992) | 22.9 (582) |
| 37780-X16 | 37780-X28 | 37780-X40 | 37780-X52 | 82.7 (2100) | 82.3 (2091) | 22.9 (582) |
| 37780-X17 | 37780-X29 | 37780-X41 | 37780-X53 | 86.6 (2200) | 86.3 (2193) | 22.9 (582) |

| Part Numbers for 31.5" W (800 mm) Enclosures | | | | Height in (mm) | Plate Size Height in (mm) | Plate Size Width in (mm) |
|--|------------|-------------|-------------|-------------------|------------------------------------|-----------------------------------|
| Enclosure Depth - in (mm) | | | | | | |
| 23.6 (600) | 31.5 (800) | 39.4 (1000) | 47.2 (1200) | | | |
| 37780-X67 | 37780-X79 | 37780-X91 | 37780-XA4 | 47.2 (1200) | 46.9 (1192) | 30.8 (783) |
| 37780-X69 | 37780-X81 | 37780-X93 | 37780-XA6 | 78.7 (2000) | 78.4 (1992) | 30.8 (783) |
| 37780-X70 | 37780-X82 | 37780-X94 | 37780-XA7 | 82.7 (2100) | 82.3 (2091) | 30.8 (783) |
| 37780-X71 | 37780-X83 | 37780-X95 | 37780-XA8 | 86.6 (2200) | 86.3 (2193) | 30.8 (783) |

X=Color; C=Black, G=Hammer Gray. Shipping Weights vary by part number: 47 to 107 lb (21.4 to 48.6 kg).



Full-Height Baying Mounting Plate

Full-Height Baying Mounting Plates are installed between two Full-Height Mounting Plates when enclosures are bayed (attached side-by-side). This creates a continuous mounting surface, connecting the two Full-Height Mounting Plates.

| Part Number | Enclosure Height in (mm) | Plate Width in (mm) | Shipping Weight lb (kg) |
|-------------|--------------------------|---------------------|-------------------------|
| 37787-X01 | 47.2 (1200) | 4.1 (104) | 11 (5.0) |
| 37787-X03 | 78.7 (2000) | 4.1 (104) | 15 (6.9) |
| 37787-X04 | 82.7 (2100) | 4.1 (104) | 16 (7.3) |
| 37787-X05 | 86.6 (2200) | 4.1 (104) | 16 (7.3) |



Bracket Kit for Inset Mount of Full-Height Baying Mounting Plate

Bracket Kit is an alternate method for mounting the Full-Height Mounting Plate. It positions the plate at the very back of the enclosure in a fixed position inset into the rear opening of the frame.

| Part Number | Shipping Weight lb (kg) |
|-------------|-------------------------|
| 37777-X01 | 6 (2.8) |

X=color: C=Black, G=Hammer Gray.



37940 Shown



37941 Shown



37942 Shown

Hardware Kits

Hardware Kits are used to attach plates, rails and accessories to the RMR Modular Enclosure frame. The interior of the frame is punched with attachment points on 1" (25 mm) increments. Traditional thread-forming screws allow direct attachment to the frame. Drop-in bolts and nuts speed installation and still provide a bonded connection.

| Part Number | Description | Shipping Weight lb (kg) |
|-------------|--|-------------------------|
| 37940-001 | M5.5 x 9 Torx Panhead Thread-Forming Screw | 2 (0.9) |
| 37941-001 | M8 x 14 Drop-in Hammer Head Bolt & M8 Flange Nut | 3 (1.4) |
| 37942-001 | M6 Drop-in Nut & M6 Hex Head Flange Screw | 3 (1.4) |

Ships in packs of 20.

Vertical Rack Busbar

Vertical Rack Busbar provides a common bonding point for rack-mount equipment. Busbar is 5/8" x 1/4" (15.88 mm x 6.4 mm) hard-drawn electrolytic tough pitch 110 alloy copper with attachment points for ground lugs. Attachment points are tapped 1/4-20, and accept two-hole lugs with 1/4" holes on 5/8" in centers. Order RMR Modular Enclosure Vertical Busbar Mounting Kit separately.



| Part Number | Length in (mm) | Attachment Points | Shipping Weight lb (kg) |
|---|----------------|-------------------|-------------------------|
| 40160-036 | 36 (910) | 8 | 4 (1.8) |
| 40160-072 | 72 (1830) | 13 | 5 (2.3) |
| Vertical Busbar Mounting Kit (for frame and rail mount) | | | |
| 37943-001 | | 2 (1.0) | |



37770 Shown



37820 Shown



37823 Shown



37739 Shown



Additional Support Accessories

Front-to-Rear Horizontal Support Slides for RMR Modular Enclosure

Use with equipment rails. Includes six slides.

Baying Kits for RMR Enclosure Systems

Baying Kits attach, or bay, two RMR Modular Enclosures together side-by-side.

- Brackets maintain the space between enclosures to ensure a tight seal
- Enclosures must be the same height and depth
- Side panels are removed or omitted from the both enclosures before the enclosures are bayed

RMR Modular Enclosure Baying Accessory Kit

Includes eight external baying brackets, two flat brackets and microcellular urethane foam seal to fill gap between enclosures.

RMR Modular Enclosure Internal Baying Accessory Kit With Seal

Includes four corner baying brackets, four flat brackets and microcellular urethane foam seal to fill gap between enclosures.

RMR Modular Enclosure Eyebolt Baying Kit

Includes two eyebolt baying brackets and installation hardware. Use with a Baying Accessory Kit.

Document Holder

Document Holder attaches to the enclosure with double backed adhesive tape.

| Part Number | Description | Shipping Weight lb (kg) |
|-------------|---|-------------------------|
| 37770-X03 | Support Slides for 23.6"D (600 mm) Cabinet | 26 (11.8) |
| 37770-X05 | Support Slides for 31.5"D (800 mm) Cabinet | 34 (15.5) |
| 37770-X07 | Support Slides for 39.4" (1000 mm) Cabinet | 41 (18.6) |
| 37770-X09 | Support Slides for 47.2"D (1200 mm) Cabinet | 49 (22.3) |
| 37820-X01 | Baying Accessory Kit | 5 (2.3) |
| 37825-X01 | Internal Baying Accessory Kit with Seal | 6 (2.8) |
| 37823-001 | Eyebolt Baying Kit | 7 (3.2) |
| 37739-X01 | Document Holder, A4 | 4 (1.9) |
| 37739-X02 | Document Holder, A3 | 5 (2.3) |

X=Color: C=Black, G=Hammer Gray.



Cabinet Includes:

- Enclosure with a hinged swing door
- Equipment mounting rails and/or mounting panels/personalized support options
- Metric hardware

RMR Swing Wall-Mount Enclosure

RMR Swing Wall-Mount Enclosure is a completely sealed, solid enclosure that features many modification possibilities. Many ventilation and cooling options are available to meet airflow requirements, and multiple cable entry points and accessories are available for configuration with short lead time.

RMR Swing Wall-Mount Enclosure features a three-part design with a solid rear section, hinged center section and a solid or windowed front door, equipped with a CH751 key-latch for security purposes. The enclosure's center section enables the front portion to release, swinging away from the wall section to provide front and rear access to equipment. This allows for quick installation and maintenance, which limits the amount of time that sensitive equipment is exposed to the environment. As a security measure to prevent unauthorized access, the center section of the RMR Swing Wall-Mount Enclosure is only accessible when the front door is unlatched.

- Provides equipment with NEMA Type 12 and IP 55 rated protection against ingress of solid foreign objects and dripping noncorrosive liquids, using advanced formed-in-place foam gasket technology at each panel and cable entry point
- Enables quick access to the front and rear of equipment through a double-hinged, swing-out design
- Supports airflow and cooling options specially certified for industrial applications to maintain equipment cooling requirements outside of normal IT settings and equipment rooms
- Features attachment points along the front, rear, top, bottom and sides, providing quick and secure mounting of plates, rails and accessories at any point along the frame
- Allows a complete enclosure solution to be configured under a single part number, including the exact size frame, mounting system, doors, gland plates and ventilation that you require
- Offers short lead times for modified enclosures—change size or color, and add openings for connections, controls and HMI

Cabinet Specifications:

- Heights:
 - 9U, 19.1" (486 mm)
 - 12U, 24.4" (619 mm)
 - 15U, 29.7" (753 mm)
 - 18U, 34.9" (886 mm)
 - 21U, 40.1" (1019 mm)
 - 26U, 48.9" (1241 mm)
- Widths: 23.6" (600 mm) and 27.6" (700 mm)
- Depths: 20.0" (510 mm), 24.0" (610 mm) and 29.9" (760 mm)
- Equipment Space: 19" EIA (482.6 mm) Equipment Mounting Rails: (1 pair) or (1) Fixed Depth Mounting Plate

Certifications:

- NEMA Type 12 and IEC 60529, IP 55

All Enclosures are:

- UL Listed, Industrial Control Panel Enclosures, Type 12, File Number NITW.E473128
- UL Listed, Industrial Control Panel
- UL Listed, Industrial Control Panel Enclosures for Canada, Type 12, File NITW7.E473128

Enclosures without filter fans or air conditioners are:

- UL Classified, Degrees of Protection by Enclosures Certified to IEC Publication, EOF1.E486325
- EIA-310-E (for 19" EIA equipment rails)- Equipment mounting rails and/or mounting panels/personalized support options
- Metric hardware

Use the part number matrix below to configure a RMR Swing Wall-Mount Enclosure. Choose the **Height**, **Width**, **Depth**, **FR**ame Style, **FR**ont Door, **RR**ear Door, **SS**ide Panel, **L**atch, **C**olor, **BP**ottom Panel and **TP**op Panel. **Example Cabinet Part Number: A3-11AA-1121-G11.3**

| | | | | | | | | | | | | | | | |
|----------|----------|----------|----------|----------|----------|-----------|----------|-----------|-----------|-----------|----------|----------|----------|-----------|-----------|
| A | 3 | - | H | W | D | FR | - | FD | RD | SP | L | - | C | BP | TP |
|----------|----------|----------|----------|----------|----------|-----------|----------|-----------|-----------|-----------|----------|----------|----------|-----------|-----------|

| | |
|----------------|----------|
| 1. Type | |
| Double-Hinged | 3 |

| | | | |
|------------------|-----------|-----------|----------|
| 2. Height | | | |
| U | in | mm | |
| 9 | 19.1 | 486 | 1 |
| 12 | 24.4 | 619 | 2 |
| 15 | 29.7 | 753 | 3 |
| 18 | 34.9 | 886 | 4 |
| 21 | 40.1 | 1019 | 5 |
| 26 | 48.9 | 1241 | 6 |

| | | |
|-----------------|-----------|----------|
| 3. Width | | |
| in | mm | |
| 23.6 | 600 | 1 |
| 27.6 | 700 | 2 |

| | | |
|-----------------|-----------|----------|
| 4. Depth | | |
| in | mm | |
| 20.0 | 510 | A |
| 24.0 | 610 | B |
| 29.9 | 760 | C |

| | |
|---|----------|
| 5. Frame Style | |
| Multi-Mount (Square-Punched) Rails, 1 Pair, 19" EIA (482.6 mm) | A |
| Fixed Depth Mounting Plate | B |
| Multi-Mount (Square-Punched) Rails, 1 Pair, 19"EIA and Fixed Depth Mounting Plate | C |

| | |
|----------------------------|----------|
| 6. Front Door | |
| Single Solid Metal Door | 1 |
| Single Tempered Glass Door | 2 |

| | |
|----------------------|-------------|
| 12. Top Panel | |
| 1 | Solid |
| 2 | Gland Panel |
| 3 | Brush Gland |

| | |
|-------------------------|--------------|
| 11. Bottom Panel | |
| 1 | Solid Bottom |
| 2 | Gland Plate |
| 3 | Brush Gland |

| | |
|------------------|----------------------|
| 10. Color | |
| C | Black |
| G | Hammer Gray RAL 7035 |

| | |
|-----------------|--|
| 9. Latch | |
| 2 | Quarter-Turn Wing Knob with CH751 Keyed Lock |

| | |
|-----------------------|--|
| 8. Side Panels | |
| 1 | Single Solid |
| 2 | Intake Filter Fan, 4.9" (125 mm), 38 CFM (65 CMH), 115 VAC |
| 4 | Cooling Unit, 900-1300 Btu/hr (263-381 W), 115 VAC |

| | |
|---------------------|----------------|
| 7. Rear Door | |
| 1 | Not Applicable |



Cabinet is comprised of

- Front Door
- Center Section
- Rear Section

Equipment mounting options include:

- Fixed Depth Mounting Plate for Rear Section
- Adjustable Depth Mounting Plate for Center Section
- Multi-Mount (Square-Punched) mounting rails for Center Section



RMR Fixed Wall-Mount Enclosure

RMR Fixed Wall-Mount Enclosure provides exceptional protection for network, communication, automation and control equipment in nonhazardous indoor locations. The RMR Fixed Wall-Mount Enclosure features welded steel panels with robotically applied, formed-in-place foam gaskets and sealed cable entry points.

These features effectively maintain the enclosure's NEMA 12 and IP 55 protection ratings, which certify the equipment is protected from the intrusion of solid foreign objects such as dirt, dust, lint and fibers, as well as noncorrosive liquid such from dripping and light spray or splashing. The RMR Fixed Wall-Mount Enclosure features a solid or windowed front door equipped with a CH751 key-latch for security purposes. The robust design of the RMR Fixed Wall-Mount Enclosure also protects personnel from hazardous moving parts and electrical equipment within the enclosure.

- Provides equipment with NEMA Type 12 and IP 55 rated protection against ingress of solid foreign objects and dripping noncorrosive liquids, using advanced formed-in-place foam gasket technology at each panel and cable entry point
- Offers airflow and cooling options specially certified for industrial applications to maintain equipment cooling requirements outside of normal IT settings and equipment rooms
- Features attachment points along the front, rear, top, bottom and sides, providing quick and secure mounting of plates, rails and accessories at any point along the frame
- Allows a complete enclosure solution to be configured under a single part number, including the exact size frame, mounting system, doors, gland plates and ventilation that you require

Cabinet Specifications:

Enclosure is rated for indoor use and protects equipment against the ingress of dust, lint and other debris, as well as dripping and splashing from noncorrosive liquids.

- Heights:
 - 9U, 19.1" (486 mm)
 - 12U, 24.4" (619 mm)
 - 15U, 29.7" (753 mm)
 - 18U, 34.9" (886 mm)
 - 21U, 40.1" (1019 mm)
 - 26U, 48.9" (1241 mm)
- Widths: 23.6" (600 mm) and 27.6" (700 mm)
- Depths: 20.0" (510 mm), 24.0" (610 mm) and 29.9" (760 mm)
- Equipment Space: 19" EIA (482.6 mm) Equipment Mounting Rails: (1 pair) or (1) Fixed Depth Mounting Plate

Certifications:

- NEMA Type 12 and IEC 60529, IP 55

All Enclosures are:

- UL Listed, Industrial Control Panel Enclosures, Type 12, File Number NITW.E473128
- UL Listed, Industrial Control Panel
- UL Listed, Industrial Control Panel Enclosures for Canada, Type 12, File NITW7.E473128

Enclosures without filter fans or air conditioners are:

- UL Classified, Degrees of Protection by Enclosures Certified to IEC Publication, EOfI.E486325
- EIA-310-E (for 19" EIA equipment rails)- Enclosure with a hinged swing door
- Equipment mounting rails and/or mounting panels/personalized support options
- Metric hardware

Cabinet Includes:

- Enclosure with a hinged swing door
- Equipment mounting rails and/or mounting panels/ personalized support options
- Metric hardware

Use the part number matrix below to configure a RMR Fixed Wall-Mount Enclosure. Choose the Height, Width, Depth, FRame Style, Front Door, Rear Door, Side Panel, Latch, Color, Bottom Panel and Top Panel. **Example Cabinet Part Number: A2-11AA-1121-G11.3**

| A | 2 | - | H | W | D | FR | - | FD | RD | SP | L | - | C | BP | TP |
|--|-----------|-----------|---|---|---|----|---|----|----|----|---|---|---|----|----|
| 1. Type | | | | | | | | | | | | | | | |
| Single Door | | 2 | | | | | | | | | | | | | |
| 2. Height | | | | | | | | | | | | | | | |
| U | in | mm | | | | | | | | | | | | | |
| 9 | 19.1 | 486 | 1 | | | | | | | | | | | | |
| 12 | 24.4 | 619 | 2 | | | | | | | | | | | | |
| 15 | 29.7 | 753 | 3 | | | | | | | | | | | | |
| 18 | 34.9 | 886 | 4 | | | | | | | | | | | | |
| 21 | 40.1 | 1019 | 5 | | | | | | | | | | | | |
| 26 | 48.9 | 1241 | 6 | | | | | | | | | | | | |
| 3. Width | | | | | | | | | | | | | | | |
| in | mm | | | | | | | | | | | | | | |
| 23.6 | 600 | 1 | | | | | | | | | | | | | |
| 27.6 | 700 | 2 | | | | | | | | | | | | | |
| 4. Depth | | | | | | | | | | | | | | | |
| in | mm | | | | | | | | | | | | | | |
| 20.0 | 510 | A | | | | | | | | | | | | | |
| 24.0 | 610 | B | | | | | | | | | | | | | |
| 29.9 | 760 | C | | | | | | | | | | | | | |
| 5. Frame Style | | | | | | | | | | | | | | | |
| Multi-Mount (Square-Punched) Rails, 1 Pair, 19" EIA (482.6 mm) | | A | | | | | | | | | | | | | |
| Fixed Depth Mounting Plate | | B | | | | | | | | | | | | | |
| 6. Front Door | | | | | | | | | | | | | | | |
| Single Solid Metal Door | | 1 | | | | | | | | | | | | | |
| Single Tempered Glass Door | | 2 | | | | | | | | | | | | | |
| 7. Rear Door | | | | | | | | | | | | | | | |
| 1 Not Applicable | | | | | | | | | | | | | | | |
| 8. Side Panels | | | | | | | | | | | | | | | |
| 1 Single Solid | | | | | | | | | | | | | | | |
| 2 Intake Filter Fan, 4.9" (125 mm), 38 CFM (65 CMH), 115 VAC | | | | | | | | | | | | | | | |
| 4 Cooling Unit, 900-1300 Btu/hr (263-381 W), 115 VAC | | | | | | | | | | | | | | | |
| 9. Latch | | | | | | | | | | | | | | | |
| 2 Quarter-Turn Wing Knob with CH751 Keyed Lock | | | | | | | | | | | | | | | |
| 10. Color | | | | | | | | | | | | | | | |
| C Black | | | | | | | | | | | | | | | |
| G Hammer Gray RAL 7035 | | | | | | | | | | | | | | | |
| 11. Bottom Panel | | | | | | | | | | | | | | | |
| 1 Solid Bottom | | | | | | | | | | | | | | | |
| 2 Gland Plate | | | | | | | | | | | | | | | |
| 3 Brush Gland | | | | | | | | | | | | | | | |
| 12. Top Panel | | | | | | | | | | | | | | | |
| 1 Solid | | | | | | | | | | | | | | | |
| 2 Gland Plate | | | | | | | | | | | | | | | |
| 3 Brush Gland | | | | | | | | | | | | | | | |



Equipment Mounting Rails

Equipment Mounting Rails provide support for 19" EIA (482.6 mm) rack-mount equipment and can be ordered with the enclosure

- Attach to the frame of the enclosure
- Adjustable-depth, supports 19" EIA (482.6 mm) rack-mount equipment
- Recommended to support cantilevered loads to eliminate equipment sag
- Universal (vertical) hole pattern, 1U are 1.75"H (44.45 mm)
- 12-24 tapped for screws or multi-mount (square-punched) for Clik-Nuts or cage nuts
- Electrically bonded to the enclosure frame



37065 Shown



37067 Shown

| Multi-Mount (Square Punched) Rails for RMR Modular Enclosure | | | | |
|--|------------|--------------------------------|-------------------------|-------------------------------|
| Part Number Width - in (mm) | | Enclosure Height in (mm) | Rack-Mount Space (U) | Shipping Weight lb (kg) |
| 23.6 (600) | 27.6 (700) | | | |
| 37065-X01 | 37065-X31 | 19.1 (486) | 9 | 6 (2.8) |
| 37065-X04 | 37065-X34 | 24.4 (619) | 12 | 7 (3.2) |
| 37065-X07 | 37065-X37 | 29.7 (753) | 15 | 8 (3.7) |
| 37065-X10 | 37065-X40 | 34.9 (886) | 18 | 8 (3.7) |
| 37065-X13 | 37065-X43 | 40.1 (1019) | 21 | 9 (4.1) |
| 37065-X18 | 37065-X48 | 48.9 (1241) | 26 | 10 (4.6) |

X= Color; C= Black and G= Hammer Gray. Shipping weight is for 27.6"W (700 mm) models.

| (12-24 Tapped) Rails for RMR Modular Enclosure | | | | |
|--|------------|--------------------------------|-------------------------|-------------------------------|
| Part Number Width - in (mm) | | Enclosure Height in (mm) | Rack-Mount Space (U) | Shipping Weight lb (kg) |
| 23.6 (600) | 27.6 (700) | | | |
| 37067-001 | 37067-031 | 19.1 (486) | 9 | 6 (2.8) |
| 37067-004 | 37067-034 | 24.4 (619) | 12 | 7 (3.2) |
| 37067-007 | 37067-037 | 29.7 (753) | 15 | 8 (3.7) |
| 37067-010 | 37067-040 | 34.9 (886) | 18 | 8 (3.7) |
| 37067-013 | 37067-043 | 40.1 (1019) | 21 | 9 (4.1) |
| 37067-018 | 37067-048 | 48.9 (1241) | 26 | 10 (4.6) |

Finish is Clear Brushed-Aluminum. Shipping weight is for 27.6"W (700 mm) models.

RMR Quick Wall-Mounting Kit

RMR Quick Wall-Mounting Kit features a cleat design that allows for quick and easy mounting of the RMR Wall-Mount Enclosure.

| Part Number | Description Width - in (mm) | Shipping Weight lb (kg) |
|-------------|--------------------------------|-------------------------------|
| 37045-X01 | 24 (610) | 12 (5.5) |
| 37045-X05 | 28 (712) | 13 (5.9) |

X= Color; C= Black and G= Hammer Gray.



Mounting Plates for

RMR Wall-Mount Enclosures

Mounting Plates are flat panels that provide a way of attaching a variety of network automation or control equipment devices into the enclosure for flexible support configurations.

- Fixed Mounting Plates are solid metal panels that are installed in a side-to-side orientation at the rear of the enclosure onto the back of the frame and can be ordered with the enclosure
- Adjustable Mounting Plates are solid metal panels that attach in a side-to-side orientation in the middle section of the enclosure and can be adjusted in depth by one inch increments and are ordered as accessories

| RMR Wall-Mount Enclosure Fixed Depth Mounting Plate | | | | | |
|---|------------|--------------------------------|----------------------------|---------------------------|-------------------------------|
| Part Number Width - in (mm) | | Enclosure Height in (mm) | Plate Height in (mm) | Plate Width in (mm) | Shipping Weight lb (kg) |
| 23.6 (600) | 27.6 (700) | | | | |
| 37075-X01 | 37075-X31 | 19.1 (486) | 14 (356) | * | 15 (6.9) |
| 37075-X04 | 37075-X34 | 24.4 (619) | 20 (508) | * | 19 (8.7) |
| 37075-X05 | 37075-X35 | 26.1 (664) | 21 (534) | * | 20 (9.1) |
| 37075-X07 | 37075-X37 | 29.7 (753) | 25 (635) | * | 22 (10.0) |
| 37075-X10 | 37075-X40 | 34.9 (886) | 30 (762) | * | 26 (11.8) |
| 37075-X13 | 37075-X43 | 40.1 (1019) | 35 (889) | * | 30 (13.7) |
| 37075-X18 | 37075-X48 | 48.9 (1241) | 44 (1118) | * | 36 (16.4) |

X=Color; C=Black, G=Hammer Gray

Plate width is 20"W (508 mm) for 23.6"W (600 mm) enclosures and 24"W (610 mm) for 27.6"W (700 mm) enclosures. *Shipping weights are for 27.6"W (700 mm) models.

| RMR Wall-Mount Enclosure Adjustable Depth Mounting Plate | | | | | |
|--|------------|--------------------------------|----------------------------|---------------------------|-------------------------------|
| Part Number Width - in (mm) | | Enclosure Height in (mm) | Plate Height in (mm) | Plate Width in (mm) | Shipping Weight lb (kg) |
| 23.6 (600) | 27.6 (700) | | | | |
| 37076-X01 | 37076-X31 | 19.1 (486) | 14 (356) | * | 15 (6.9) |
| 37076-X04 | 37076-X34 | 24.4 (619) | 20 (508) | * | 19 (8.7) |
| 37076-X07 | 37076-X37 | 29.7 (753) | 25 (635) | * | 22 (10.0) |
| 37076-X10 | 37076-X40 | 34.9 (886) | 30 (762) | * | 26 (11.8) |
| 37076-X13 | 37076-X43 | 40.1 (1019) | 35 (889) | * | 30 (13.7) |
| 37076-X18 | 37076-X48 | 48.9 (1241) | 44 (1118) | * | 36 (16.4) |

X=Color; C=Black, G=Hammer Gray

*Plate width is 20"W (508 mm) for 23.6"W (600 mm) enclosures and 24"W (610 mm) for 27.6"W (700 mm) enclosures. *Shipping weights are for 27.6"W (700 mm) models.



Lag Bolt Mounting Kit

Lag Bolt Mounting Kit includes (6) M8 x 40 mm Lag Bolts and Sealing Washers for attaching the enclosure to a plywood back board.

| Part Number | Shipping Weight - lb (kg) |
|-------------|---------------------------|
| 37049-001 | 3 (1.4) |



Vertical Lashing Bracket

Vertical Cable Lashing Bracket creates a simple, separate vertical pathway for a small cable bundles and has multiple slots for straps or tie wraps to secure cables to the bracket.

- May be installed in front of or behind the equipment mounting rails or on either side of the cabinet frame
- An array of slots compatible with zip-ties
- Bracket is 1.6"W (41 mm)
- Includes: Brackets, installation hardware; order cable ties separately
- Material: Steel
- Electrically bonded to the enclosure frame

| Part Number | Description Height in (mm) | Shipping Weight lb (kg) |
|-------------|----------------------------|-------------------------|
| 37082-X01 | 19.1 (486) | 4 (1.5) |
| 37082-X04 | 24.4 (619) | 5 (2.3) |
| 37082-X07 | 29.7 (753) | 5 (2.3) |
| 37082-X10 | 34.9 (886) | 5 (2.3) |
| 37082-X13 | 40.1 (1019) | 6 (2.8) |
| 37082-X18 | 48.9 (1241) | 6 (2.8) |

X= Color; C= Black and G= Hammer Gray.



Short Finger Cable Manager

Short Finger Cable Manager is a T-shaped cable guide that creates a pathway for cables next to the rail for better organization. Use it with Front-to-Rear Lashing Bracket for optimum performance.

- Attaches to and adjusts with mounting rails
- Passes up to 24 cables per U space through openings
- Includes: Finger Cable Manager and installation hardware
- Material: Steel panels, plastic guides and latches

| Part Number | Enclosure Height in (mm) | Rack-Mount Space (U) | Shipping Weight lb (kg) |
|-------------|--------------------------|----------------------|-------------------------|
| 37086-X01 | 19.1 (486) | 9 | 5 (2.3) |
| 37086-X04 | 24.4 (619) | 12 | 5 (2.3) |
| 37086-X07 | 29.7 (753) | 15 | 5 (2.3) |
| 37086-X10 | 34.9 (886) | 18 | 6 (2.7) |
| 37086-X13 | 40.1 (1019) | 21 | 6 (2.7) |
| 37086-X18 | 48.9 (1241) | 26 | 7 (3.2) |

X= Color; C= Black and G= Hammer Gray.

Front-To-Rear Cable Lashing Bracket

Front-to-Rear Cable Lashing Bracket routes high volumes of cables from front-to-rear of the cabinet, preventing cabling from invading the U space below the cable run.

- Attaches to the frame to create a dedicated front to rear pathway
- Includes: Trough and installation hardware; Material: Steel bracket



| Part Number | Description Depth - in (mm) | Shipping Weight lb (kg) |
|-------------|--------------------------------|----------------------------|
| 37084-X01 | 20.0 (510) | 4 (1.5) |
| 37084-X02 | 24.0 (610) | 4 (1.5) |
| 37084-X03 | 29.9 (760) | 5 (2.3) |

X= Color; C= Black and G= Hammer Gray.

Brush Cable Entry Grommet

When NEMA Type 12 and IP 55 protection ratings are not essential, Brush Cable Entry Grommet helps block dust and particles from entering through cable access holes, while providing easier access to cables. Place grommets at the bottom openings for optimum protection.

- Material: Metal backed strip brush, nylon bristles with EPDM layer, plastic brush holder



| Part Number | Enclosure Width in (mm) | Opening Size Width in (mm) | Opening Size Depth in (mm) | Shipping Weight lb (kg) |
|-------------|----------------------------|----------------------------------|----------------------------------|----------------------------|
| 37097-001 | 23.6 (600) | 20.9 (532) | 3.5 (89) | 4 (1.9) |
| 37097-005 | 27.6 (700) | 24.9 (632) | 3.5 (89) | 4 (1.9) |

RMR Wall-Mount Enclosure Grounding Lug Kit

Grounding Lug Kit includes a Two-Hole Compression Lug sized for a #6 AWG conductor with .375" (9.5 mm) holes spaced on 1" (25.4 mm) centers and mounting hardware. Attaches to the RMR Wall-Mount Enclosure frame to provide a bonding point for the enclosure.



| Part Number | Description | Shipping Weight lb (kg) |
|-------------|-------------|----------------------------|
| 37009-001 | Ground Lug | 2 (0.9) |

RMR Wall-Mount Enclosure Busbar Kit

Busbar Kit includes a 19"L (482.6 mm), 3/4"H (19.1 mm), 3/16" thick (4.8 mm) hard-drawn electrolytic tough pitch 110 alloy copper bar with eight #6-32 tapped lug mounting holes on 1" (25.4 mm) centers, two insulators and mounting hardware. Attaches to the RMR Wall-Mount Enclosures on the back panel and provides a common bonding point for equipment within the enclosure.



| Part Number | Description | Shipping Weight lb (kg) |
|-------------|-------------|----------------------------|
| 37008-001 | Busbar Kit | 4 (1.9) |



UL Type 12/IP 55

UL Type 4/IP 66
NEMA Type 4X/IP 66

RMR Floor-Mount Enclosure

RMR Floor-Mount Enclosures provide exceptional material ingress protection for panel-mount networking, automation, control and instrumentation equipment in indoor and outdoor locations. Stainless steel option is available for applications that require a higher level of corrosion resistance.

RMR Floor-Mount Enclosures feature floor stands that provide additional clearance and easy access for cable access through the bottom of the enclosure. The floor stands are bolted onto the frame and can be easily removed for relocation of the enclosure.

Eight heavy-duty mounting studs on the rear of the enclosure accept a mounting plate. The high-strength, solid mounting plate (ordered separately), attaches to the enclosure and provides a large mounting surface for equipment.

UL Type 4/IP 66 and NEMA 4X/IP 66 enclosures feature a removable center beam to maintain sealing performance between doors. Remove the center beam to conveniently mount large equipment onto the mounting plate, or to install the mounting plate with preinstalled equipment onto the frame. UL Type 12/IP 55 enclosures feature overlapping solid double doors with three-point latch but do not include a center beam.

- CPI Product Designer tool quickly configures a complete kit
- Sealed with continuous foam gasket technology
- Kitting and preinstallation of accessories to simplify ordering
- Competitive lead times

Key Features:

- UL Type 1, 2, 3, 3R, 4, 5, 12; IP 55/66*
- NEMA Type 4X, 3X and 3RX in stainless steel*
- For indoor and outdoor use
- Floor stands provide additional clearance and easy access to bottom of the enclosure
- Available in stainless steel with brushed finish for corrosive environments
- Continuous foam gasket seal
- Solid double door
- Three lock styles: keyed, double bit and square
- Wide range of sizes available

Note: Field modifications, including the addition of accessories, may result in a different protection rating.

Configure to Order Online:



CPI Product Designer creates unique industrial enclosures quickly and easily by allowing you to select the size, features and accessories needed for a specific application. Access this tool at chatsworth.com/product-designer.

RMR® Floor-Mount Enclosures provide NEMA Type 4, 4X or 12 protection for large electronic components and controls that require sturdy mounting. Floor stands elevate the enclosure above the floor for added clearance and easier cable access.

Specifications/Ordering Notes:

For simplified ordering and full range of sizes and configurations, go to the CPI Product Designer at chatsworth.com/product-designer.



UL Type 12/IP 55

RMR Floor-Mount Enclosure, Type 12, with Floor Stand and Solid Double Door

UL Type 12/IP 55 enclosure is for indoor use; protects against dirt, dripping and light splash of noncorrosive liquid. Stainless steel option provides additional corrosion protection.

- Designed for NEMA Type 12/IP 55 applications. Also meets NEMA Type 1 and 5; and NEMA Type 2 with drain hole and NEMA Type 3R with drain hole and drip shield (hole must be between 1/8" to 1/4" (3 mm - 6 mm))
- Overlapping solid double door with 3-point latch mechanism provides easy access for control plate installation
- Latch style: 3-point mechanism with heavy-duty padlock swinghandle
- 3 lock styles: keyed CH751, double bit and square
- Min and max height: 54"H - 72"H (1372 mm - 1829 mm)
- Min and max widths: 42"W - 72"W (1067 mm - 1829 mm)
- Min and max depths: 8"D - 24"D (203 mm - 610 mm)
- Removable floor stands
- Available in welded mild steel with powder coat paint finish (colors): Gray ANSI 61, Hammer Gray RAL7035 and Black. Stainless steel Type 304 in No. 4 brushed finish option is also available.

Series A04, mild steel, and Series A50, stainless steel, families of enclosures
Sample part number: A04-HHWWDD-X00/A50-HHWWDD-X00

Configure to Order Online:



CPI Product Designer creates unique industrial enclosures quickly and easily by allowing you to select the size, features and accessories needed for a specific application. Access this tool at chatsworth.com/product-designer.

Specifications/Ordering Notes:

For simplified ordering and full range of sizes and configurations, go to the CPI Product Designer at chatsworth.com/product-designer.



UL Type 4/IP 66
NEMA Type 4X/IP 66

RMR Floor-Mount Enclosure, Type 4, with Floor Stand and Solid Double Door

UL Type 4/IP 66 enclosure is for outdoor use, protects against dirt, rain, sleet, snow, splash and hose down with noncorrosive liquid. Removable center beam provides convenient installation of mounting plate.

- Designed for NEMA Type 4/IP 66 applications. Also meets NEMA Type 1, 3, 5 and 12; and NEMA Type 2 and 3R with drain hole (hole must be between 1/8" to 1/4" (3 mm - 6 mm))
- Removable center beam
- 3 lock styles: keyed CH751, double bit and square
- Latch styles: 3-point mechanism with heavy-duty padlock swinghandle.
Auxiliary ¼-turn latches are added on top and bottom of enclosures that are 31"W (787 mm) or wider
- Min and max height: 60"H - 74"H (1524 mm - 1880 mm)
- Min and max widths: 48"W - 72"W (1219 mm - 1829 mm)
- Min and max depths: 10"D - 24"D (254 mm - 610 mm)
- Removable floor stands
- Available in welded mild steel with outdoor-rated, powder coat paint finish (colors): Gray ANSI 61, Hammer Gray RAL7035 and Black

Series 05, mild steel, family of enclosures

Sample part number: A05-HHWWDD-X00

RMR Floor-Mount Enclosure, Type 4X, with Floor Stand and Solid Double Door

NEMA Type 4X/IP 66 enclosure is for indoor or outdoor use, protects against dirt, rain, sleet, snow, splash and hose down with an increased level of corrosion resistance. Removable center beam provides convenient installation of mounting plate.

- Provides enhanced corrosion protection from salt and certain chemicals over painted enclosure
- Designed for NEMA Type 4X/IP 66 applications. Also meets NEMA Type 1, 3, 3X, 4, 5 and 12; and NEMA Type 2, 3R and 3RX with drain hole (hole must be between 1/8" to 1/4" (3 mm - 6 mm))
- Removable center beam
- 3 lock styles: keyed CH751, double bit and square
- Latch styles: 3-point mechanism with heavy-duty padlock swinghandle.
Auxiliary ¼-turn latches are added on top and bottom of enclosures that are 31"W (787 mm) or wider
- Min and max height: 60"H - 74"H (1524 mm - 1880 mm)
- Min and max widths: 48"W - 72"W (1219 mm - 1829 mm)
- Min and max depths: 10"D - 24"D (254 mm - 610 mm)
- Removable floor stands
- Available in welded, Type 304 stainless steel in No. 4 brushed finish

Series A51, stainless steel, family of enclosures

Sample part number: A51-HHWWDD-X00

Configure to Order Online:



CPI Product Designer creates unique industrial enclosures quickly and easily by allowing you to select the size, features and accessories needed for a specific application. Access this tool at chatsworth.com/product-designer.

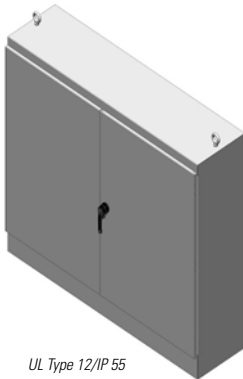

UL Type 12/IP 55



NEMA Type 4

RMR Free-Standing Enclosure

RMR Free-Standing Enclosures by Chatsworth Products (CPI) provide exceptional material ingress protection for panel-mount networking, automation, control and instrumentation equipment in indoor and outdoor locations. Stainless steel option is available for applications that require a higher level of corrosion resistance.

Enclosures have mounting channels along the sides, top and bottom for attaching mounting plates (ordered separately) or other accessories. The mounting plate can be placed anywhere along the enclosure's mounting channels. Dual-access configuration is available for equipment access from either the front or rear of the enclosure and for back-to-back plate mounting.

The enclosure can be configured with single or dual access, solid single or double doors with a three-point latch mechanism. NEMA Type 4 or Type 4X enclosures with double doors feature removable center beam to maintain sealing performance between doors.

NEMA Type 12 enclosures feature overlapping solid double doors with three-point latch, but do not include a center beam.

- CPI Product Designer tool quickly configures a complete kit
- Sealed with continuous foam gasket technology
- Kitting and preinstallation of accessories to simplify ordering
- Competitive lead times

Key Features:

- UL Type 1, 2, 3, 3R, 4, 5, 12; IP 55/66*
- NEMA Type 4X, 3X and 3RX in stainless steel*
- For indoor and outdoor use
- Available in stainless steel with brushed finish for corrosive environments
- Easy-to-use side channels for mounting
- Continuous foam gasket seal
- Wide range of sizes available
- Single- and double-door options
- 3-point latch with choice of lock
- Optional adjustable-depth mounting plate

Note: Field modifications, including the addition of accessories, may result in a different protection rating.

Configure to Order Online:



CPI Product Designer creates unique industrial enclosures quickly and easily by allowing you to select the size, features and accessories needed for a specific application. Access this tool at chatsworth.com/product-designer.

RMR® Free-Standing Enclosures provide NEMA Type 4, 4X or 12 protection for large electronic components and controls that require sturdy mounting.

Specifications/Ordering Notes:

For simplified ordering and full range of sizes and configurations, go to the CPI Product Designer at chatsworth.com/product-designer.

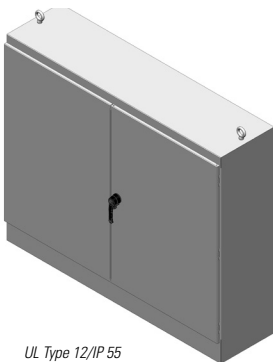

UL Type 12/IP 55

RMR Free-Standing Enclosure, Type 12, with Solid Double Door

UL Type 12/IP 55 enclosure is for indoor use and protects against dirt, dripping and light splash of noncorrosive liquid. Stainless steel option provides additional corrosion protection.

- Designed for NEMA Type 12/IP 55 applications. Also meets NEMA Type 1 and 5; and NEMA Type 2 with drain hole and NEMA Type 3R and 3RX with drain hole and drip shield (hole must be between 1/8" to 1/4" (3 mm - 6 mm))
- Overlapping solid double door with 3-point latch mechanism provides easy access for control preinstallation
- Latch style: 3-point mechanism with heavy-duty padlock swinghandle
- 3 lock styles: keyed CH751, double bit and square
- Min and max height: 60"H - 90"H (1524 mm - 2286 mm)
- Min and max widths: 48"W - 72"W (1219 mm - 1829 mm)
- Min and max depths: 18"D - 36"D (457 - 914)
- Available in welded mild steel with powder coat paint finish (colors): Gray ANSI 61, Hammer Gray RAL7035 and Black. Stainless steel Type 304 in No. 4 brushed finish option is also available.
- 4 eye bolts are included with enclosures that are over 24"D (610 mm)
- Order mounting plate(s) separately; use CPI Product Designer for quick and easy selection.

Series A06, mild steel, and Series A52, stainless steel, families of enclosures
Sample part number: A06-HHWWDD-X00/A52-HHWWDD-X00



UL Type 12/IP 55

RMR Free-Standing Enclosure, Type 12, Dual Access with Solid Double Door

UL Type 12/IP 55 enclosure is for indoor use and protects against dirt, dripping and light splash of noncorrosive liquid.

- Designed for NEMA Type 12/IP 55 applications. Also meets NEMA Type 1 and 5; NEMA Type 2 with drain hole and NEMA Type 3R with drain hole and drip shield (hole must be between 1/8" to 1/4" (3 mm - 6 mm))
- Dual access provides additional mounting plate placement and access to either front or rear of the enclosure
- Overlapping solid double door with 3-point latch mechanism provides easy access for control plate installation
- Latch style: 3-point mechanism with heavy-duty padlock swinghandle
- 3 lock styles: keyed CH751, double bit and square
- Min and max height: 72"H - 90"H (1829 mm - 2286 mm)
- Min and max widths: 48"W - 72"W (1219 mm - 1829 mm)
- Min and max depths: 24"D - 36"D (610 mm - 914 mm)
- Available in welded, mild-steel with powder coat paint finish (colors): Gray ANSI 61, Hammer Gray RAL7035 and Black
- 4 eye bolts are included with enclosures that are over 24"D (610 mm)
- Order mounting plate(s) separately; use CPI Product Designer for quick and easy selection.

Series A07, mild steel, family of enclosures
Sample Part number: A07-HHWWDD-X00

Specifications/Ordering Notes:

For simplified ordering and full range of sizes and configurations, go to the CPI Product Designer at chatsworth.com/product-designer.



UL Type 4/IP 66
NEMA Type 4X/IP 66

RMR Free-Standing Enclosure, Type 4, with Solid Double Door

UL Type 4/IP 66 enclosure is for outdoor use and protects against dirt, rain, sleet, snow, splash and hose down with noncorrosive liquid.

- Designed to meet NEMA Type 4/IP 66 applications. Also meets NEMA Type 1, 3, 5, and 12; and NEMA Type 2 and 3R with drain hole (hole must be between 1/8" to 1/4" (3 mm - 6 mm))
- Solid double doors and center beam. Removable center beam provides convenient installation of mounting plate
- 3 lock styles: keyed CH751, double bit and square
- Latch style: 3-point mechanism with heavy-duty padlock swinghandle. Auxiliary ¼-turn latches are added on top and bottom of enclosures that are 31"W (787 mm) or wider
- Min and max height: 60"H - 90"H (1524 mm - 2286 mm)
- Min and max widths: 48"W - 72"W (1219 mm - 1829 mm)
- Min and max depths: 18"D - 36"D (457 mm - 914 mm)
- Available in welded mild steel with outdoor-rated, powder coat paint finish (colors): Gray ANSI 61, Hammer Gray RAL7035 and Black
- 4 eye bolts are included with enclosures that are over 24"D (610 mm)
- Order mounting plate(s) separately; use CPI Product Designer for quick and easy selection

Series A08, mild steel, family of enclosures

Sample Part number: A08-HHWWDD-X00

RMR Free-Standing Enclosure, Type 4X, with Solid Double Door

NEMA Type 4X/IP 66, for indoor or outdoor use, protects against dirt, rain, sleet, snow, splash and hose down with an increased level of corrosion resistance. Removable center beam provides convenient installation of mounting plate.

- Provides enhanced corrosion protection from salt and certain chemicals over painted enclosure
- Designed for NEMA Type 4X/IP 66 applications. Also meets NEMA Type 1, 3, 3X, 4, 5 and 12; and NEMA Type 2, 3R and 3RX with drain hole (hole must be between 1/8" to 1/4" (3 mm - 6 mm))
- Removable center beam
- 3 lock styles: keyed CH751, double bit and square
- Latch style: 3-point mechanism with heavy-duty padlock swinghandle. Auxiliary ¼-turn latches are added on top and bottom of enclosures that are 31"W (787 mm) or wider
- Min and max height: 60"H - 90"H (1524 mm - 2286 mm)
- Min and max widths: 48"W - 72"W (1219 mm - 1829 mm)
- Min and max depths: 18"D - 36"D (457 mm - 914 mm)
- Available in welded, Type 304 stainless steel in No. 4 brushed finish

Series A54, stainless steel, family of enclosures

Sample Part number: A54-HHWWDD-X00

Configure to Order Online:



CPI Product Designer creates unique industrial enclosures quickly and easily by allowing you to select the size, features and accessories needed for a specific application. Access this tool at chatsworth.com/product-designer.

Specifications/Ordering Notes:

For simplified ordering and full range of sizes and configurations, go to the CPI Product Designer at chatsworth.com/product-designer.



UL Type 4/IP66 and 12/IP 55
NEMA Type 4X/IP 66

RMR Free-Standing Enclosure, Type 4 and 12, with Solid Single Door

UL Type 4/IP66 and 12/IP 55 enclosures are for either indoor or outdoor use and protect against dirt, rain, sleet, snow, splash and hose down with noncorrosive liquids.

- Designed for NEMA Type 4/IP 66 and 12/IP 55 applications. Also meets NEMA Type 1 and 5; and NEMA Type 2 and 3R with drain hole (hole must be between 1/8" to 1/4" (3 mm - 6 mm))
- 3 lock styles: keyed CH751, double bit and square
- Latch styles: 3-point mechanism with heavy-duty padlock swinghandle. Auxiliary ¼-turn latches are added on top and bottom of enclosures that are 31"W (787 mm) or wider
- Min and max height: 60"H - 90"H (1524 mm - 2286 mm)
- Min and max widths: 24"W - 36"W (610 mm - 914 mm)
- Min and max depths: 18"D - 36"D (457 mm - 914 mm)
- Available in welded mild steel with outdoor-rated, powder coat paint finish (colors): Gray ANSI 61, Hammer Gray RAL7035 and Black
- 4 eye bolts are included with enclosures that are over 24"D (610 mm)

Series A09, mild steel, family of enclosures

Sample Part number: A09-HHWWDD-X00

RMR Free-Standing Enclosure, Type 4X, with Solid Single Door

NEMA Type 4X/IP 66, for outdoor or indoor use, protects against dirt, rain, sleet, snow, splashing and hose-directed water, along with an increased level of corrosion protection

- Designed for NEMA Type 4X/IP 66 applications. Also meets NEMA Type 1, 3, 3X, 4, 5 and 12; and NEMA Type 2, 3R and 3RX with drain hole (hole must be between 1/8" to 1/4" (3 mm - 6 mm))
- 3 lock styles: keyed CH751, double bit and square
- Latch styles: 3-point mechanism with heavy-duty padlock swinghandle. Auxiliary ¼-turn latches are added on top and bottom of enclosures that are 31"W (787 mm) or wider
- Min and max height: 60"H - 90"H (1524 mm - 2286 mm)
- Min and max widths: 24"W - 36"W (610 mm - 914 mm)
- Min and max depths: 18"D - 36"D (457 mm - 914 mm)
- Available in welded, Type 304 stainless steel in No. 4 brushed finish
- 4 eye bolts are included with enclosures that are over 24"D (610 mm)

Series A55, stainless steel, family of enclosures

Sample Part number: A55-HHWWDD-X00

Configure to Order Online:



CPI Product Designer creates unique industrial enclosures quickly and easily by allowing you to select the size, features and accessories needed for a specific application. Access this tool at chatsworth.com/product-designer.

Specifications/Ordering Notes:

For simplified ordering and full range of sizes and configurations, go to the CPI Product Designer at chatsworth.com/product-designer.



UL Type 4/IP 66 and 12/IP 55
NEMA Type 4X/IP 66

RMR Free-Standing Enclosure, Type 4 and 12, Dual Access with Solid Single Door

UL Type 4/IP 66 and 12/IP 55 enclosures are for either indoor or outdoor use and protect against dirt, rain, sleet, snow, splash and hose down with noncorrosive liquids.

- Meets NEMA Type 4/IP 66 and 12/IP 55 applications. Also meets NEMA Type 1, 3 and 5; and NEMA Type 2 and 3R with drain hole (hole must be between 1/8" to 1/4" (3 mm - 6 mm))
- Dual access provides additional mounting plate placement and access to either side of the enclosure
- 3 lock styles: keyed CH751, double bit and square
- Latch styles: 3-point mechanism with heavy-duty padlock swinghandle. Auxiliary ¼-turn latches are added on top and bottom of enclosures that are 30" (762 mm) wide or wider
- Min and max height: 72"H – 90"H (1829 mm - 2286 mm)
- Min and max widths: 24"W – 36"W (610 mm - 914 mm)
- Min and max depths: 24"W – 36"W (610 mm - 914 mm)
- Available in welded mild steel with outdoor-rated, powder coat paint finish (colors): Gray ANSI 61, Hammer Gray RAL7035 and Black
- 4 eye bolts are included with enclosures that are over 24"D (610 mm)

Series A10, mild steel, family of enclosures

Sample Part number: A10-HHWWDD-X00

RMR Free-Standing Enclosure, Type 4X, Dual Access with Solid Single Door

NEMA Type 4X/IP 66, for outdoor or indoor use, protects against dirt, rain, sleet, snow, splashing and hose-directed water, along with an increased level of corrosion protection

- Made of stainless steel for NEMA Type 4X/IP 66 applications. Also meets NEMA Type 1, 3, 3X, 4, 5 and 12; and NEMA Type 2, 3R and 3RX with drain hole (hole must be between 1/8" to 1/4" (3 mm - 6 mm))
- Dual access provides additional mounting plate placement and access to either side of the enclosure
- 3 lock styles: keyed CH751, double bit and square
- Latch styles: 3-point mechanism with heavy-duty padlock swinghandle. Auxiliary ¼-turn latches are added on top and bottom of enclosures that are 30" (762 mm) wide or wider
- Min and max height: 72"H – 90"H (1829 mm - 2286 mm)
- Min and max widths: 24"W – 36"W (610 mm - 914 mm)
- Min and max depths: 24"W – 36"W (610 mm - 914 mm)
- Available in welded, Type 304 stainless steel in No. 4 brushed finish
- 4 eye bolts are included with enclosures that are over 24"D (610 mm)

Series A56, stainless steel, family of enclosures

Sample Part number: A56-HHWWDD-X00

Configure to Order Online:



CPI Product Designer creates unique industrial enclosures quickly and easily by allowing you to select the size, features and accessories needed for a specific application. Access this tool at chatsworth.com/product-designer.



UL Type 4/IP 66 and 12/IP 55
NEMA Type 4X/IP 66



UL Type 12/IP 55

RMR® Standard Wall-Mount Enclosures provide NEMA Type 4, 4X or 12 protection for smaller electronic components and controls that require sturdy wall mounting.

RMR Standard Wall-Mount Enclosure

RMR Standard Wall-Mount Enclosures by Chatsworth Products (CPI) provide exceptional material ingress protection for panel-mount networking, automation, control and instrumentation equipment in indoor or outdoor locations. Stainless steel option is available for applications that require a higher level of corrosion resistance.

Mount equipment into the enclosure with mounting plates (ordered separately). The removable mounting plates attach to the rear of the enclosure. Use the optional Swing-Out Kit for RMR Mounting Plate (ordered separately) to install the mounting plate at the front of the enclosure.

UL Type 4/IP 66 and NEMA Type 4X/IP 66 enclosures with double doors feature a removable center beam to maintain sealing performance between doors. UL Type 12/IP 55 enclosures feature overlapping solid double doors with three-point latch but do not include a center beam.

- CPI Product Designer tool quickly configures a complete kit
- Sealed with continuous foam gasket technology
- Kitting and preinstallation of accessories to simplify ordering
- Competitive lead times

Key Features:

- UL Type 1, 2, 3, 3R, 4, 5, 12: IP 55/66*
- NEMA Type 4X, 3X and 3RX in stainless steel*
- For indoor and outdoor use
- Continuous foam gasket seal
- Integrated mounting holes or welded mounting brackets
- Wide range of sizes available
- Single- and double-door options
- 3-point or 1/4-turn latch with choice of lock
- Optional rear mounting plate

Note: Field modifications, including the addition of accessories, may result in a different protection rating.

Configure to Order Online:



CPI Product Designer creates unique industrial enclosures quickly and easily by allowing you to select the size, features and accessories needed for a specific application. Access this tool at chatsworth.com/product-designer.

Specifications/Ordering Notes:

For simplified ordering and full range of sizes and configurations, go to the CPI Product Designer at chatsworth.com/product-designer.



UL Type 4/IP 66 and 12/IP 55
NEMA Type 4X/IP 66

RMR Standard Wall-Mount Enclosure, Type 4 and 12 with Single Door

UL Type 4/IP 66 and 12/IP 55 enclosures are for either indoor or outdoor use and protect against dirt, rain, sleet, snow, splash and hose down with noncorrosive liquids.

- Complies with NEMA Type 4/IP 66 and 12/IP 55 applications. Also meets NEMA Type 1, 3, and 5; and NEMA Type 2 and 3R with drain hole (hole must be between 1/8" to 1/4" (3 mm - 6 mm))
- Solid or tempered glass single door options
- 2 latch styles: 3-point mechanism and ¼-turn latch. Auxiliary ¼-turn latches are added on top and bottom of enclosures with doors that are 31"W (787 mm) or wider
- 4 lock styles: keyed CH751, double bit and square on 3-point latches; double bit, square and slotted on ¼-turn latches
- 2 mounting methods: integrated mounting hole or welded mounting bracket
- Min and max height: 12"H – 72"H (305 mm - 1829 mm)
- Min and max widths: 10"W – 36"W (254 mm - 914 mm)
- Min and max depths: 6"D – 24"D (152 mm - 610 mm)
- Available in welded mild steel with outdoor-rated, powder coat paint finish (colors): Gray ANSI 61, Hammer Gray RAL7035 and Black

Series A11, mild steel, family of enclosures
Sample Part number: A11-HHWWDD-X00

RMR Standard Wall-Mount Enclosure, Type 4X with Single Door

NEMA Type 4X/IP 66, for outdoor or indoor use, protects against dirt, rain, sleet, snow, splashing and hose-directed water, along with an increased level of corrosion protection.

- Made of stainless steel for NEMA Type 4X/IP 66 applications. Also meets NEMA Type 1, 3, 3X, 4, 5 and 12; and NEMA Type 2, 3R and 3RX with drain hole (hole must be between 1/8" to 1/4" (3 mm - 6 mm))
- Solid single door
- 2 latch styles: 3-point mechanism and ¼-turn latch. Auxiliary ¼-turn latches are added on top and bottom of enclosures with doors that are 31"W (787 mm) or wider
- 4 lock styles: keyed CH751, double bit and square on 3-point latches; double bit, square and slotted on ¼-turn latches
- 2 mounting methods: integrated mounting hole or welded mounting bracket
- Min and max height: 12"H – 72"H (305 mm - 1829 mm)
- Min and max widths: 10"W – 36"W (254 mm - 914 mm)
- Min and max depths: 6"D – 24"D (152 mm - 610 mm)
- Stainless steel Type 304 in No. 4 brushed finish

Series A57, stainless steel, family of enclosures
Sample Part number: A57-HHWWDD-X00

Configure to Order Online:



CPI Product Designer creates unique industrial enclosures quickly and easily by allowing you to select the size, features and accessories needed for a specific application. Access this tool at chatsworth.com/product-designer.

Specifications/Ordering Notes:

For simplified ordering and full range of sizes and configurations, go to the CPI Product Designer at chatsworth.com/product-designer.



UL Type 12/IP 55

RMR Standard Wall-Mount Enclosure, Type 12 with Solid Double Door

UL Type 12/IP 55 enclosures are for indoor use and protect against dirt, rain, light splash and with noncorrosive liquids.

- Designed for NEMA Type 12/IP 55 applications. Also meets NEMA Type 1 and 5; NEMA Type 2 with drain hole and NEMA Type 3R and 3RX (stainless steel) with drain hole and drip shield (hole must be between 1/8" to 1/4" (3 mm - 6 mm))
- Solid, overlapping double door
- 2 mounting methods: integrated mounting hole or welded mounting bracket
- Latch styles: 3-point mechanism
- 3 lock styles: keyed CH751, double bit and square
- Min and max height: 24"H – 48"H (610 mm - 1219 mm)
- Min and max widths: 42"W – 60"W (1067 mm - 1524 mm)
- Min and max depths: 8"D – 16"D (203 mm - 406 mm)
- Available in welded mild steel with powder coat paint finish (colors): Gray ANSI 61, Hammer Gray RAL7035 and Black. Stainless steel Type 304 in No. 4 brushed finish option is also available

Series A12, mild steel, and A58, stainless steel, families of enclosures

Sample part number: A12-HHWWDD-X00/A58-HHWWDD-X00

Configure to Order Online:



CPI Product Designer creates unique industrial enclosures quickly and easily by allowing you to select the size, features and accessories needed for a specific application. Access this tool at chatsworth.com/product-designer.

Specifications/Ordering Notes:

For simplified ordering and full range of sizes and configurations, go to the CPI Product Designer at chatsworth.com/product-designer.



UL Type 4/ IP 66
NEMA Type 4X/IP 66

RMR Standard Wall-Mount Enclosure, Type 4 with Solid Double Door

UL Type 4/ IP 66 enclosure is for outdoor use and protects against dirt, rain, sleet, snow, splash and hose down with noncorrosive liquid.

- Designed for UL Type 4/ IP 66 applications. Also meets NEMA Type 1, 3, 5 and 12; and NEMA Type 2 and 3R with drain hole (hole must be between 1/8" to 1/4" (3 mm - 6 mm))
- Solid double doors and center beam. Removable center beam provides convenient installation of mounting plate
- 4 lock styles: keyed CH751, double bit, square and slotted
- 2 latch styles: 3-point and ¼-turn. Auxiliary ¼-turn latches are added on top and bottom of enclosures that are 31"W (787 mm) or wider
- 2 mounting methods: integrated mounting hole or welded mounting bracket
- Min and max height: 24"H – 48"H (610 mm - 1219 mm)
- Min and max widths: 42"W – 60"W (1667 mm - 1524 mm)
- Min and max depths: 8"D – 16"D (203 mm - 406 mm)
- Available in welded mild steel with outdoor-rated, powder coat paint finish (colors): Gray ANSI 61, Hammer Gray RAL7035 and Black

Series A13, mild steel, family of enclosures

Sample Part number: A13-HHWWDD-X00

RMR Standard Wall-Mount Enclosure, Type 4X with Solid Double Door

NEMA Type 4X/IP 66, for outdoor or indoor use, protects against dirt, rain, sleet, snow, splashing and hose-directed water, along with an increased level of corrosion protection.

- Designed for NEMA Type 4X/IP 66 applications. Also meets NEMA Type 1, 3, 3X, 4, 5 and 12; and NEMA 2, 3R and 3RX with drain hole (hole must be between 1/8" to 1/4" (3 mm - 6 mm))
- Solid single door
- 2 latch styles: 3-point mechanism and ¼-turn latch. Auxiliary ¼-turn latches are added on top and bottom of enclosures with doors that are 31"W (787 mm) or wider
- 4 lock styles: keyed CH751, double bit and square on 3-point latches; double bit, square and slotted on ¼-turn latches
- 2 mounting methods: integrated mounting hole or welded mounting bracket
- Min and max height: 12"H – 72"H (305 mm - 1829 mm)
- Min and max widths: 10"W – 36"W (254 mm - 914 mm)
- Min and max depths: 6"D – 24"D (152 mm - 610 mm)
- Stainless steel Type 304 in No. 4 brushed finish

Series A59, stainless steel, family of enclosures

Sample Part number: A59-HHWWDD-X00

Configure to Order Online:



CPI Product Designer creates unique industrial enclosures quickly and easily by allowing you to select the size, features and accessories needed for a specific application. Access this tool at chatsworth.com/product-designer.



UL Type 4/IP66 or
NEMA Type 4X/IP 66

RMR Flange-Mount Disconnect Enclosure, Floor-Mount

RMR Flange-Mount Disconnect Enclosure, Floor-Mount, by Chatsworth Products (CPI) provide exceptional material ingress protection for panel-mount networking, automation, control and instrumentation equipment in indoor and outdoor locations. Stainless steel option is available for applications that require a higher level of corrosion resistance.

The floor stands provide additional clearance and easy access for cable access through the bottom of the enclosure. The floor stands are bolted onto the frame and can be easily removed for relocation of the enclosure.

- CPI Product Designer tool quickly configures a complete kit
- Continuous formed-in-place foam gasket
- Kitting and preinstallation of accessories to simplify ordering
- Competitive lead times

Key Features:

- UL Type 1, 2, 3, 3R, 4, 5, 12; IP 55/66*
- NEMA Type 4X, 3X and 3RX in stainless steel*
- For indoor and outdoor use
- Standard cutout on the right flange provides mounting for major brands of disconnect switches and circuit breakers
- Floor stands provide additional clearance and easy access to bottom of the enclosure
- Solid double door
- Three lock styles: keyed, double bit and square
- Available in stainless steel with brushed finish for corrosive environments
- Wide range of sizes available

Note: Field modifications, including the addition of accessories, may result in a different protection rating.

Configure to Order Online:



CPI Product Designer creates unique industrial enclosures quickly and easily by allowing you to select the size, features and accessories needed for a specific application. Access this tool at chatsworth.com/product-designer.

RMR® Flange-Mount Disconnect Enclosure, Floor-Mount, provides NEMA Type 4 or 4X protection for large electronic equipment. It is designed to house major brands of disconnect switches and circuit breakers. Floor stands elevate the enclosure above the floor for added clearance and easier cable access.

Specifications/Ordering Notes:

For simplified ordering and full range of sizes and configurations, go to the CPI Product Designer at chatsworth.com/product-designer.



UL Type 4/IP66 or
NEMA Type 4X/IP 66

RMR Flange-Mount Disconnect Enclosure, Floor-Mount, Type 4 or 4X with Floor Stand and Solid Double Door

UL Type 4/IP66 or NEMA Type 4X/IP 66, for indoor or outdoor use, protects against dirt, rain, sleet, snow, splash and hose down with liquids. Stainless steel enclosures provide an added layer of protection against corrosion.

- Designed for NEMA Type 4/IP66 or 4X/IP 66 applications. Also meets NEMA Type 1, 3, 3X, 5 and 12; and NEMA Type 2, 3R and 3RX with drain hole (hole must be between 1/8" to 1/4" (3 mm - 6 mm))
- Standard cutout accepts most standard disconnect handles
- Removable center beam
- 3 lock styles: keyed CH751, double bit and square
- Latch styles: 3-point mechanism with heavy-duty padlock defeater handle. Auxiliary ¼-turn latches are added on top and bottom of enclosures that are 31"W (787 mm) or wider
- Min and max height: 60"H - 74"H (1524 mm - 1880 mm)
- Min and max widths: 48"W - 72"W (1219 mm - 1829 mm)
- Min and max depths: 10"D - 24"D (254 mm - 610 mm)
- Removable floor stands
- Available in outdoor-rated, powder coat paint finish (colors): Gray ANSI 61, Hammer Gray RAL7035 and Black.
- NEMA Type 4X/IP 66 enclosures are available in stainless steel Type 304 in No. 4 brushed finish

Series A30, mild steel, and Series A70, stainless steel, families of enclosures
Sample part number: A30-HHWWDD-X00/A70-HHWWDD-X00

Configure to Order Online:



CPI Product Designer creates unique industrial enclosures quickly and easily by allowing you to select the size, features and accessories needed for a specific application. Access this tool at chatsworth.com/product-designer.

RMR® Flange-Mount Disconnect Enclosure, Floor-Mount, provides NEMA Type 4 or 4X protection for large electronic equipment. It is designed to house major brands of disconnect switches and circuit breakers. Floor stands elevate the enclosure above the floor for added clearance and easier cable access.



UL Type 4/IP 66 or NEMA Type 4X/IP 66



UL Type 4/IP 66 and NEMA Type 4X/IP 66

RMR Flange-Mount Disconnect Enclosure, Free-Standing

RMR Flange-Mount Disconnect Enclosures, Free-Standing, by Chatsworth Products (CPI) provide exceptional material ingress protection for panel-mount networking, automation, control and instrumentation equipment in indoor and outdoor locations.

Stainless steel option is available for applications that require a higher level of corrosion resistance.

- CPI Product Designer tool quickly configures a complete kit
- Continuous formed-in-place foam gasket technology
- Kitting and preinstallation of accessories to simplify ordering
- Competitive lead times

Key Features:

- UL Type 1, 2, 3, 3R, 4, 5, 12; IP 55/66*
- NEMA Type 4X, 3X and 3RX in stainless steel*
- For indoor and outdoor use
- Standard cutout on the right flange provides mounting for major brands of disconnect switches and circuit breakers
- Available in stainless steel with brushed finish for corrosive environments
- Wide range of sizes available

Note: Field modifications, including the addition of accessories, may result in a different protection rating.

Configure to Order Online:



CPI Product Designer creates unique industrial enclosures quickly and easily by allowing you to select the size, features and accessories needed for a specific application. Access this tool at chatsworth.com/product-designer.

RMR® Flange-Mount Disconnect Enclosure, Free-Standing, provides NEMA Type 4 or 4X protection for large electronic components and controls that require sturdy mounting. It is designed to house major brands of disconnect switches and circuit breakers.

Specifications/Ordering Notes:

For simplified ordering and full range of sizes and configurations, go to the CPI Product Designer at chatsworth.com/product-designer.



UL Type 4/IP 66 or NEMA Type 4X/IP 66

RMR Flange-Mount Disconnect Enclosure, Free-Standing, Type 4 or 4X with Solid Double Door

UL Type 4/IP 66 or NEMA Type 4X/IP 66 enclosures are for either indoor or outdoor use and protects against dirt, rain, sleet, snow, splash and hose down with liquids. Stainless steel enclosures provide an added layer of protection against corrosion.

- Designed to meet NEMA Type 4/IP 66 or 4X/IP 66 applications. Also meets NEMA 1, 3, 3X, 5 and 12; and NEMA Type 2, 3R and 3RX with drain hole (hole must be between 1/8" to 1/4" (3 mm - 6 mm))
- Standard cutout accepts most standard disconnect handles
- Solid double doors and center beam. Removable center beam provides convenient installation of mounting plate
- 3 lock styles: keyed CH751, double bit and square
- Latch style: 3-point mechanism with heavy-duty padlock defeater handle. Auxiliary ¼-turn latches are added on top and bottom of enclosures that are 31"W (787 mm) or wider
- Min and max height: 60"H - 90"H (1524 mm - 2286 mm)
- Min and max widths: 48"W - 72"W (1219 mm - 1829 mm)
- Min and max depths: 18"D - 36"D (457 mm - 914 mm)
- Available in welded mild steel with outdoor-rated, powder coat paint finish (colors: Gray ANSI 61, Hammer Gray RAL7035 and Black)
- NEMA Type 4X/IP 66 enclosures are available in stainless steel Type 304 in No. 4 brushed finish
- 4 eye bolts are included with enclosures that are over 24"D (610 mm); order mounting plate(s) separately

Series A31, mild steel, and Series A71, stainless steel, families of enclosures
Sample Part number: A31-HHWWDD-X00/A71-HHWWDD-X00



UL Type 4/IP 66 and NEMA Type 4X/IP 66

RMR Flange-Mount Disconnect Enclosure, Free-Standing, Type 4 or 4X with Solid Single Door

UL Type 4/IP 66 and NEMA Type 4X/IP 66 enclosures are for either indoor or outdoor use and protect against dirt, rain, sleet, snow, splash and hose down with liquids. Stainless steel enclosures provide an added layer of protection against corrosion.

- Designed for NEMA Type 4/IP 66 or 4X/IP 66 applications. Also meets NEMA Type 1, 3, 3X, 5 and 12; and NEMA Type 2, 3R and 3RX with drain hole (hole must be between 1/8" to 1/4" (3 mm - 6 mm))
- Standard cutout accepts most standard disconnect handles
- 3 lock styles: keyed CH751, double bit and square
- Latch styles: 3-point mechanism with heavy-duty padlock defeater handle. Auxiliary ¼-turn latches are added on top and bottom of enclosures that are 31"W (787 mm) or wider
- Min and max height: 60"H - 90"H (1524 mm - 2286 mm)
- Min and max widths: 24"W - 36"W (610 mm - 914 mm)
- Min and max depths: 18"D - 36"D (457 mm - 914 mm)
- Available in welded mild steel with outdoor-rated, powder coat paint finish (colors: Gray ANSI 61, Hammer Gray RAL7035 and Black)
- NEMA Type 4X/IP 66 enclosures are available in stainless steel Type 304 in No. 4 brushed finish
- 4 eye bolts are included with enclosures that are over 24"D (610 mm)

Series A32, mild steel, and Series A72, stainless steel, families of enclosures
Sample Part number: A32-HHWWDD-X00/A72-HHWWDD-X00



UL Type 4/IP 66 or NEMA Type 4X/IP 66



UL Type 4/IP 66 or NEMA Type 4X/IP 66

RMR Flange-Mount Disconnect Enclosure, Standard Wall-Mount

RMR Flange-Mount Disconnect Enclosure, Standard Wall-Mount, features a welded steel or stainless steel frame with continuous foam gaskets, which maintain the enclosure's protection ratings. Stainless steel option is available for applications that require a higher level of corrosion resistance.

Mount equipment into the enclosure with mounting plates (ordered separately). The removable mounting plates attach to the rear of the enclosure. Use the optional Swing-Out Kit for RMR Mounting Plate (ordered separately) to install the mounting plate at the front of the enclosure.

UL Type 4/IP 66 and NEMA Type 4X/IP 66 enclosures with double doors feature a removable center beam to maintain sealing performance between doors. Remove the center beam to conveniently mount large equipment onto the mounting plate, or to install the mounting plate with preinstalled equipment onto the frame.

- CPI Product Designer tool quickly configures a complete kit
- Continuous formed-in-place foam gasket technology
- Kitting and preinstallation of accessories to simplify ordering
- Competitive lead times

Key Features:

- UL Type 1, 2, 3, 3R, 4, 5, 12; IP 55/66*
- NEMA Type 4X, 3X and 3RX in stainless steel*
- For indoor and outdoor use
- Standard cutout on the right flange provides mounting for major brands of disconnect switches and circuit breakers
- Integrated mounting holes or welded mounting brackets
- Available in stainless steel with brushed finish for corrosive environments
- Continuous foam gasket seal
- Wide range of sizes available

Note: Field modifications, including the addition of accessories, may result in a different protection rating.

Configure to Order Online:



CPI Product Designer creates unique industrial enclosures quickly and easily by allowing you to select the size, features and accessories needed for a specific application. Access this tool at chatsworth.com/product-designer.

RMR® Flange-Mount Disconnect Enclosure, Standard Wall-Mount, provide NEMA Type 4 or 4X protection for smaller electronic components and controls that require sturdy wall mounting. It is designed to house major brands of disconnect switches and circuit breakers.

Specifications/Ordering Notes:

For simplified ordering and full range of sizes and configurations, go to the CPI Product Designer at chatsworth.com/product-designer.



UL Type 4/IP 66 or NEMA Type 4X/IP 66

RMR Flange-Mount Disconnect Enclosure, Standard Wall-Mount, Type 4 or 4X with Single Door

UL Type 4/IP 66 or NEMA Type 4X/IP 66 enclosures are for either indoor or outdoor use and protect against dirt, rain, sleet, snow, splash and hose down with liquids. Stainless steel enclosures provide an added layer of protection against corrosion.

- Designed for NEMA Type 4/IP 66 or 4X/IP 66 applications. Also meets NEMA Type 1, 3, 3X, 5 and 12; and NEMA Type 2, 3R and 3RX with drain hole (hole must be between 1/8" to 1/4" (3 mm - 6 mm))
- Solid or tempered glass single door options
- 2 latch styles: 3-point mechanism and ¼-turn latch. Auxiliary ¼-turn latches are added on top and bottom of enclosures with doors that are 31"W (787 mm) or wider
- 4 lock styles: keyed CH751, double bit and square on 3-point latches; double bit, square and slotted on ¼-turn latches
- 2 mounting methods: integrated mounting hole or welded mounting bracket
- Min and max height: 24"H – 72"H (305 mm - 1829 mm)
- Min and max widths: 20"W – 36"W (254 mm - 914 mm)
- Min and max depths: 6"D – 24"D (152 mm - 610 mm)
- Available in welded mild steel with outdoor-rated, powder coat paint finish (colors: Gray ANSI 61, Hammer Gray RAL7035 and Black)
- NEMA Type 4X/IP 66 enclosures are available in stainless steel Type 304 in No.4 brushed finish

Series A33, mild steel, and Series A73, stainless steel, families of enclosures
Sample Part number: A33-HHWWDD-X00/A73-HHWWDD-X00



UL Type 4/IP 66 or NEMA Type 4X/IP 66

RMR Flange-Mount Disconnect Enclosure, Standard Wall-Mount, Type 4 or 4X with Solid Double Door

UL Type 4/IP 66 or NEMA Type 4X/IP 66 enclosure is for outdoor use and protects against dirt, rain, sleet, snow, splash and hose down with liquid. Stainless steel enclosures provide an added layer of protection against corrosion.

- Designed for NEMA 4/IP 66 or 4X/IP 66 applications. Also meets NEMA Type 1, 3, 3X, 5 and 12; and NEMA Type 2, 3R and 3RX with drain hole (hole must be between 1/8" to 1/4" (3 mm - 6 mm))
- Standard cutout accepts most standard disconnect handles
- Solid double doors and center beam. Removable center beam provides convenient installation of mounting plate
- 4 lock styles: keyed CH751, double bit, square and slotted
- 2 latch styles: 3-point and ¼-turn. Auxiliary ¼-turn latches are added on top and bottom of enclosures that are 31"W (787 mm) or wider
- 2 mounting methods: integrated mounting hole or welded mounting bracket
- Min and max height: 38"H – 48"H (610 mm - 1219 mm)
- Min and max widths: 42"W – 60"W (1067 mm - 1524 mm)
- Min and max depths: 8"D – 16"D (203 mm - 406 mm)
- Available in welded mild steel with outdoor-rated, powder coat paint finish (colors: Gray ANSI 61, Hammer Gray RAL703 and Black)
- NEMA Type 4X/IP 66 enclosures are available in stainless steel Type 304 in No.4 brushed finish

Series A34, mild steel, and Series A74, stainless steel, families of enclosures
Sample Part number: A34-HHWWDD-X00/A74-HHWWDD-X00

RMR Enclosure Accessories



Swing-Out Plate
Mounting Kit

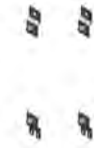

Bracket Kit for RMR
Standard Wall-Mount
Enclosure



Grounding and
Bonding Kit



Drip Shield Assembly

Swing-Out Plate Mounting Kit

The Swing-Out Plate Mounting Kit installs at the front of the enclosures and converts a standard mounting plate into a swing-out mounting plate (ordered separately). The Kit includes brackets, hinges and mounting hardware that attach to the front of the enclosure to allow easy access to electronic components.

Mounting Bracket Kit for RMR Standard Wall-Mount Enclosure

The Mounting Bracket Kit mounts RMR Standard Wall-Mount Cabinets to the wall.

- Required for NEMA Type 4, 4X and IP 66 applications.
 - Stainless steel option required for NEMA 4X application
- Includes 4 brackets and screws.

RMR Enclosure Grounding and Bonding Kit

The RMR Enclosure Grounding and Bonding Kit provides bonding to the enclosure or bonds the optional mounting plate. Includes a 12" L (305 mm), 6-gauge with dual M8 ring terminals and hardware. Compatible with RMR Floor-Mount, RMR Free-Standing and RMR Standard Wall-Mount Enclosures.

RMR Enclosure Drip Shield Assembly

Required to meet NEMA Type 3R when using a NEMA Type 12/IP 55 enclosure. It is used to provide additional protection against ice and rain.

Refer to enclosure ordering tables for sampling of Drip Shield Assembly part numbers. Go to the CPI Product Designer chatsworth.com/product-designer to configure an RMR Enclosure with Drip Shield Assembly.

| Part Number | Description | Shipping Weight lb (kg) |
|-------------------|--|-------------------------|
| DF0021-000000-X01 | Swing-Out Plate Mounting Kit 37" - 62" (940 mm - 1575 mm) | 4 (1.8) |
| DF0032-000000-X01 | Swing-Out Plate Mounting Kit 37" - 62" (940 mm - 1575 mm) | 5.5 (2.5) |
| DF0033-000000-X01 | Swing-Out Plate Mounting Kit 37" - 62" (940 mm - 1575 mm) | 3 (1.4) |
| DF0024-000000-X01 | Mounting Bracket Kit for RMR Standard Wall-Mount Enclosures | 1 (0.5) |
| DF0063-000000-401 | Mounting Bracket Kit for RMR Stainless Steel Standard Wall-Mount Enclosures | 1 (0.5) |
| DF0023-000000-001 | Grounding and Bonding Kit | 0.5 (0.2) |

Note: X=Color: (-G00) for Hammer Gray RAL 7035, (-H00) for Light Gray ANSI 61.



CPI Product Designer creates unique industrial enclosures quickly and easily by allowing you to select the size, features and accessories needed for a specific application. Access this tool at chatsworth.com/product-designer.

RMR Enclosure Accessories

Solid Mounting Plates

Solid Mounting Plates are installed at the rear of the enclosure frame. Network, automation and control equipment devices can be installed onto the mounting plate. Refer to enclosure ordering tables for sampling of mounting plate part numbers. Go to the CPI Product Designer at chatsworth.com/product-designer to configure.



Solid Mounting Plate



Threaded Drain Plug Kit

RMR Enclosure Threaded Drain Plug Kit

The RMR Enclosure Threaded Drain Plug Kit prevents accumulation of condensed water by allowing it to drain out the bottom of the enclosure. The drain plugs also vent air out of the enclosures, helping to equalize air pressure. Install vent drains at the bottom of the enclosures. Includes vent drain and retaining nut. Compatible with all RMR Enclosures.

RMR Enclosure Door Stop Kit

The RMR Enclosure Door Stop Kit secures the door of the enclosure in the open position. It can be mounted on either left- or right-hinged doors. Includes mounting hardware. Kit includes door stop and mounting hardware. Compatible with RMR Floor-Mount, RMR Free-Standing and RMR Standard Wall-Mount Enclosures.



XL Polyvent Protective Vent Kit

RMR Enclosure XL Polyvent Protective Vent Kit

RMR Enclosure XL Polyvent Protective Vent Kit provides ventilation and equalizes air pressure in the event of drastic temperature changes. Pressure equalization is essential to protect the enclosure seal from damage. Installation hardware included. Kit includes vent and retaining nut. Compatible with all RMR enclosures.

LED Light Kit

The LED Light Kit provides additional lighting inside the enclosure. Two types available: On-off switch or motion sensor. Voltage: 100 - 240 V, 50/60 Hz; NEMA 1-15P power cord.



LED Light Kits

| Part Number | Description | Shipping Weight lb (kg) |
|-------------------|---|-------------------------|
| DF0025-000000-001 | RMR Enclosure Threaded Drain Plug Kit | 1 (0.5) |
| DF0022-000000-001 | RMR Enclosure Door Stop Kit | 1 (0.5) |
| DF0028-000000-001 | RMR Enclosure XL Polyvent Protective Vent Kit | 0.5 (0.2) |
| DF0030-000000-001 | LED Light Kit, On-Off Switch | 0.5 (0.2) |
| DF0031-000000-001 | LED Light Kit, Motion Sensor | 0.5 (0.2) |



Thermal Management Accessories for RMR Enclosure Systems

CPI offers a comprehensive line of Filter Fans and cooling units that provide superior thermal management to help protect the life of the electronic equipment in environments that require NEMA Type 12 and IP 55 protection. Three cooling methods are available to address different applications and requirements:

- Forced Convection
- Natural Convection
- Closed-Loop Cooling

Forced Convection with Filter Fans

Use CPI Filter Fans to propel the cool, ambient air into the enclosure. The patented click mechanism on the Filter Fans has a unique, four-corner fastening system that enables safe and quick, tool-less installation, while maintaining the rated seal, and allowing the filter medium to be replaced in seconds.

For intake fans, once installed, a slight positive pressure builds up inside the cabinet, so that only air filtered by the Filter Fans flows into the enclosure. The air propelled into the cabinet displaces the warm air that exits through the exhaust filter.

The fluted filter mat's folded structure provides airflow and maintains the required NEMA Type 12 protection, while also extending the filter's lifetime 300 percent longer than conventional filters.

- Multiple sizes available
- Top-, side- or front-mounting
- Easy, tool-less installation
- Maintains NEMA Type 12 protection rating
- Hinged grill allows easy filter replacement
- Optimized airflow and reduced energy consumption
- High-quality fluted filter mat provides 300% longer service time

Specifications:

- Includes: Fan housing, fan, filter, installation hardware
- Installation: Snap fastener without screws
- Housing Material: Injection-molded thermoplastic, self-extinguishing, UL 94 V0; top fan also has a painted metal cover
- Power Connection: Terminal Strip Approvals; UL®, cUL, CE Marking



RMR Modular Enclosure Filter Fan

| Part Number Type of Filter | | Cutout Size in (mm) | Airflow CFM (CMH) | Voltage | Color | Shipping Weight lb (kg) |
|-------------------------------|-----------|---------------------------|-------------------------|---------|-------------|-------------------------------|
| Intake | Exhaust | | | | | |
| 37920-001 | 37920-002 | 7 (177) | 65 (110) | 115 | Hammer Gray | 2 (0.9) |
| 37920-003 | 37920-004 | 7 (177) | 65 (110) | 230 | Hammer Gray | 2 (0.9) |
| 37920-005 | 37920-006 | 7 (177) | 65 (110) | 115 | Black | 2 (0.9) |
| 37920-007 | 37920-008 | 7 (177) | 65 (110) | 230 | Black | 2 (0.9) |
| 37921-001 | 37921-002 | 11.5 (291) | 560 (951) | 115 | Hammer Gray | 2 (0.9) |
| 37921-003 | 37921-004 | 11.5 (291) | 560 (951) | 230 | Hammer Gray | 2 (0.9) |
| 37921-005 | 37921-006 | 11.5 (291) | 560 (951) | 115 | Black | 2 (0.9) |
| 37921-007 | 37921-008 | 11.5 (291) | 560 (951) | 230 | Black | 2 (0.9) |



Filter Fans

| RMR Modular Enclosure Top Exhaust Fan | | | | | |
|---------------------------------------|---------------------|-------------------|---------|-------------|-------------------------|
| Part Number | Cutout Size in (mm) | Airflow CFM (CMH) | Voltage | Color | Shipping Weight lb (kg) |
| 37903-001 | 11.5 (291) | 441 (749) | 115 | Hammer Gray | 2 (0.9) |

Note: Use Top Exhaust Filter Fan Kit with two Intake Filter Kits. All kits should be the same size.

| RMR Power Cord For Filter Fan | | | |
|-------------------------------|------------|------------|-------------------------|
| Part Number | Voltage | Plug Type | Shipping Weight lb (kg) |
| 37902-001 | 115 | NEMA 5-15P | 2 (0.9) |
| 37902-002 | 230 | NEMA 6-15P | 2 (0.9) |
| 37902-003 | 115 or 230 | IEC C14 | 2 (0.9) |

Color: Black. Order one Power Cord per Filter Fan Kit. Match to Fan Voltage requirement.

| RMR Wall-Mount Enclosure Filter Fan | | | | | | |
|-------------------------------------|-----------|---------------------|-------------------|---------|-------------|-------------------------|
| Part Number Fan Configuration | | Cutout Size in (mm) | Airflow CFM (CMH) | Voltage | Color | Shipping Weight lb (kg) |
| Intake | Exhaust | | | | | |
| 37101-001 | 37101-002 | 6 (153) | 38 (65) | 115 | Hammer Gray | 5 (2.3) |
| 37101-003 | 37101-004 | 6 (153) | 38 (65) | 230 | Hammer Gray | 5 (2.3) |
| 37101-005 | 37101-006 | 6 (153) | 38 (65) | 115 | Black | 5 (2.3) |
| 37101-007 | 37101-008 | 7 (177) | 38 (65) | 230 | Black | 5 (2.3) |

Note: Use Filter Fan Kit with a Filter Kit. Both kits should be the same size.



Filter Kits

Effective when the amount of heat being removed from the enclosure is minimal.

| RMR Modular Enclosure Filter Kit | | |
|----------------------------------|-----------------------|-------------------------|
| Part Number | Filter Cutout in (mm) | Shipping Weight lb (kg) |
| 37898-00X | 7 (177) | 2 (1) |
| 37899-00X | 11.5 (291) | 3 (2) |

X=color, 1=Hammer Gray, 2=Black

| RMR Replacement Filter Mats | | | |
|-----------------------------|-----------------------|-------------|-------------------------|
| Part Number | Filter Cutout in (mm) | Filter Type | Shipping Weight lb (kg) |
| 37116-001 | 4.9 (125) | 150G/M2 | 2 (0.9) |
| 37117-001 | 4.9 (125) | Fluted | 3 (2.0) |

| RMR Wall-Mount Enclosure Filter Kit | | |
|-------------------------------------|-----------------------|-------------------------|
| Part Number | Filter Cutout in (mm) | Shipping Weight lb (kg) |
| 37102-00X | 4.9 (125) | 4 (1.9) |

X=color, 1=Hammer Gray, 2=Black



Note: P/N 39700-XXX is recommended for use with 37872-XXX or 37896-XXX door.

P/N 37901-XXX is recommended for use with 37879-XXX /side Panel.

Closed Loop Cooling

Closed-loop cooling is required when the ambient temperature is greater than the target internal temperature of the enclosure, or when higher ingress protection (NEMA Type 12 rating) is necessary. CPI offers closed-loop cooling units by Pfannenberg, which consist of two separate circulation systems. One system seals out the ambient air, cooling and recirculating clean, cool air throughout the enclosure. The second system uses ambient air to remove and discharge the heat.

Cooling units operate on the principle of the Carnot cycle. This means that the cooling unit functions as a heat pump that “pumps” the thermal energy transferred from the electronic enclosure (heat dissipated from the components) up to a higher level of temperature (the ambient temperature can reach levels as high as + 55 °C). At the same time, the air inside the enclosure is cooled down by the evaporator and dehumidified.

When using cooling units, ensure a good supply of air intake and outtake from the external circuit of the cooling unit, so that thermal energy can be transferred to the surroundings. The lowest temperature inside the enclosure may not necessarily be the best. CPI recommends an inside temperature of 95 °F (35 °C), which represents a good compromise between service life and the accumulation of condensation.

- Closed loop isolates the external ambient air from the internally conditioned air, at the same time, the rise of contaminants entering the enclosure
- Multiple sizes available
- Side- or front-mounting
- Performs efficiently in high-temperature areas
- Uses environmentally friendly HFC-free R134a refrigerant
- Backward curve impeller fan optimizes airflow and extends service life
- Wide condenser fin spacing reduces particulate clogging while balancing performance
- Hermetically sealed compressors prevent refrigerant loss
- Actively evaporates condensation
- Condensate drain port for emergency overflow

RMR Modular Enclosure Indoor NEMA Type 12 Cooling Units—3000-4000 BTU/hr (879-1172 W) Capacity

Attaches to the outside of the AC Door Assembly.

- Cooling Unit is 30”H (750 mm) x 16”W (397 mm) x 10”D (239 mm).

| Part Number | Voltage | Color | Shipping Weight lb (kg) |
|-------------|---------|-------------|-------------------------|
| 37900-001 | 115 | Hammer Gray | 100 (45.4) |
| 37900-002 | 230 | Hammer Gray | 100 (45.4) |
| 37900-003 | 115 | Black | 100 (45.4) |
| 37900-004 | 230 | Black | 100 (45.4) |

RMR Modular Enclosure Indoor NEMA Type 12 Cooling Units—3000-4000 BTU/hr (879-1172 W) Capacity

Attaches to the outside of the AC Door Assembly.

- Cooling Unit is 30”H (750 mm) x 16”W (397 mm) x 10”D (239 mm).

| Part Number | Voltage | Color | Shipping Weight lb (kg) |
|-------------|---------|-------------|-------------------------|
| 37901-001 | 115 | Hammer Gray | 100 (45.4) |
| 37901-002 | 230 | Hammer Gray | 100 (45.4) |
| 37901-003 | 115 | Black | 100 (45.4) |
| 37901-004 | 230 | Black | 100 (45.4) |

| Power Cord for Cooling Units | | | |
|------------------------------|---------|-----------|-------------------------|
| Part Number | Voltage | Plug Type | Shipping Weight lb (kg) |
| 37908-001 | 125 | 5-15P | 2 (1.0) |
| 37908-002 | 230 | 6-15P | 2 (1.0) |
| 37908-003 | 250 | IEC C14 | 2 (1.0) |



37912 Shown

Roxtec Sealing Systems for RMR Enclosure Systems

Roxtec sealing solutions maintain the enclosure's NEMA Type 12 and IP 55 protection ratings around cable openings.

- Compact seals provide equipment protection against water, dust, insects and rodents
- 2-piece grommet assembly includes a frame and multidiameter modules that seal around cables
- Each grommet includes several modules to pass multiple cables of various diameters

| Part Number | Roxtec Model Frame/ Modules | Cutout Size | Depth in (mm) | # of Cables | Cable Diameter Range in (mm) | Shipping Weight lb (kg) |
|----------------|-----------------------------|-------------|---------------|-------------|------------------------------|-------------------------|
| 37912-001 | ComSeal 10/10 | 2.2 (56) | 5.8 (149) | 20 | .138 - .650 (3.5 - 16.5) | 4 (1.9) |
| 37913-001 | ComSeal 15/3 | 2.4 (61) | 7.6 (195) | 3 | 1.102 - 1.693 (28 - 43) | 4 (1.9) |
| 37914-001 | ComSeal 16/16 | 2.2 (56) | 8.2 (209) | 16 | .138 - .650 (3.5 - 16.5) | 4 (1.9) |
| 37915-001 | ComSeal 32/32 | 4.0 (103) | 8.2 (209) | 32 | .138 - .650 (3.5 - 16.5) | 5 (2.3) |
| RMR Gland Seal | | | | | | |
| 37916-001 | RG M63/4 | 2.5 (63) Ø | .157 (4) | 4 | .138 - .650 (3.5 - 16.5) | 4 (1.9) |
| 37917-001 | RG M63/9 | 2.5 (63) Ø | .157 (4) | 4 | .138 - .650 (3.5 - 16.5) | 4 (1.9) |

Note: On ComSeal, allow a 15 mm clearance around the cutout for securing the grommet to the enclosure. On RG M63, allow a 10 mm diameter space around the cutout for securing the grommet. The ComSeal frame is .59" H (15 mm). The RG M63 frame is 2" H (51.5 mm). Refer to installation instructions for exact cutout dimensions. For other options, please contact CPI.



RMR EPDM Snap-In Liquid Tight Grommet

Snap-In Liquid Tight Grommet keeps liquids from leaking through cable openings

- Meets NEMA Type 12 and IP 55 protection ratings
- Accepts a single cable with diameter range 1.06"–1.38" (27-35 mm)
- Knock-out panel opening should be 1.98" (50 mm)
- Fits panel thickness range 0.05"–0.20" (1.3-5.1 mm)

| Part Number | Shipping Weight - lb (kg) |
|-------------|---------------------------|
| 37115-001 | 4 (1.9) |

Cellular Wireless Enclosures

CPI's indoor- and outdoor-rated RMR solutions support and secure next-generation small cell radio nodes, power electronics and network connections.



Accommodates:

- CommScope® ONECELL®
- Corning® SpiderCloud®
- Ericsson® Radio Dot
- Huawei® LampSite®
- Nokia® AirScale®
- Sunwave® CrossFire®
- Other small cell nodes may fit, check equipment usable area

RMR Wall-Mount Enclosure

RMR Wall-Mount Enclosure provide NEMA Type 4 protection for small cell radio nodes or wireless access points (APs), antennas and small switches located in harsh environments.

- Environmental Protection – Advanced formed-in-place foam gasket technology provides UL and NEMA Type 4 for indoor and outdoor spaces
- Equipment Support - Removable back plate for equipment mounting. Removable top plug provides opening for antenna mounting
- Equipment Security – Keyed latch and ability to wall-mount provides an added layer of security

Specifications:

- Frame:
 - Welded, mild-steel
 - Prepunched mounting holes for use with included Wall-Mounting Bracket Kit
 - Preinstalled solid, removable mounting plate
- Door:
 - Single solid
 - (2) Slotted 1/4 Turn Latches for gasket compression; (1) Keyed Ch751 1/4 Turn Latch for security
 - Bonding stud and wire included
 - Concealed hinges
- Sealing: Formed-in-place foam gaskets
- Overall Dimensions: 32”H x 20”W x 9”D (813 mm x 508 mm x 229 mm)
- Back Plate: 30”H x 18.4”W (762 mm x 467.4 mm)
- Equipment Usable Area: 28” H x 18.4” W x 6.6”D (711.2 mm x 467.4 x 167.6)
- Cable Opening: (1) prepunched 1” (25.4 mm) hole for antenna mounting and cabling
- Installation: Wall-Mounting Bracket Kit included
- Finish: Powder coated, Hammer Gray

Certifications:

NEMA Type 4, for indoor or outdoor use, is mild steel and protects against dirt, rain, sleet, snow, splashing and hose-directed water. It also meets NEMA Type 1, 3, 5, 12, and NEMA Type 2 and 3R with drain hole.

Type 4 Enclosures are:

- UL Listed, Industrial Control Panel Enclosures, Type 1, 2, 3, 3R, 4, 5 and 12; File Number NITW.E473128
- UL Listed, Industrial Control Panel Enclosures for Canada, Type 1, 2, 3, 3R, 4, 5 and 12, File NITW7.E473128
- UL Classified to IP 66 Degrees of Protection by Enclosures Certified to IEC Publication, EOFI. E486325
- RoHS, REACH

Includes:

- (1) Preinstalled mounting plate
- (1) Wall-Mounting Bracket Kit
- (2) Keys

| Part Number | Description | Shipping Weight lb (kg) |
|-------------|---|-------------------------|
| 52020-G00 | RMR Wall-Mount Enclosure 32”H x 20”W x 9”D (813 mm x 508 mm x 229 mm) | 83 (37.7) |

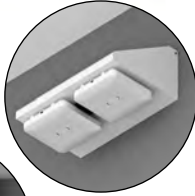

Accommodates:

Accommodates:

- CommScope® ONECELL®
- Corning® SpiderCloud®
- Ericsson® Radio Dot
- Huawei® LampSite®
- Nokia® AirScale®
- Sunwave® CrossFire®
- Other small cell nodes may fit, check equipment usable area.

RMR Wall-Mount Right Angle

RMR Wall-Mount Right Angle conveniently mounts and protects up to two small cell radio nodes or access points (APs) on the wall in locations with high or inaccessible ceilings.

- **Wireless Coverage** – Design allows small cells to be mounted in the preferred horizontal orientation for optimal wireless coverage
- **Space-saving Capability** - Install and secure up to two small cells in one location
- **Convenient Mounting** - Can be mounted directly over telecommunications outlet, concealing outlet, connectors and cabling

Specifications:

- Wedge shaped, right-angle mounting bracket with locking cover is ideal in applications with high or inaccessible ceilings or locations where it is hard or difficult to penetrate ceilings. Accommodates two small cells or access points. Sidewalls feature knockouts for trade size 1" (25.4 mm) conduit connectors.
- **Dimensions:** Size: 8.5"H x 20.9"W x 14"D (216 mm x 531 mm x 356 mm), (2) Sidewall knockouts for trade size 1" (25.4 mm) conduit
- **Back Plate:** 20.9"W x 14"D (530.7 mm x 355.6 mm)
- **Equipment Usable Area:** 20.9"W x 14"D (530.7 mm x 355.6 mm)
- **Cable Opening:** (2) prepunched 1" (25.4 mm) knockouts for cable access along the side of the bracket (1 per side)
- **Construction:** 18 gauge steel
- **Load Rating:** 25 lbs (11.4 kg)
- **Cover:** Fully hinged, solid cover
- **Finish:** Powder coated, White

Certifications:

- RoHS

Includes:

- (1) Right-angle wall mount bracket with locking cover
- (2) Mounting plate inserts
- (2) T-bar mounting brackets
- (8) M4 x 6 screws
- (4) #6-32 Screws
- (4) 1/4-20 Screws

| Part Number | Description | Shipping Weight lb (kg) |
|-------------|---|-------------------------|
| 52021-960 | RMR Wall-Mount Right Angle Enclosure 8.5"H x 20.9"W x 14"D (216 mm x 531 mm x 356 mm) | 15 (6.8) |



52022-960 Shown

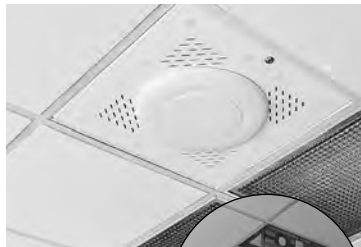

52022-961 Shown



RMR Ceiling Enclosures

RMR Ceiling Enclosures secure and protect up to four small cell radio nodes or access points (APs), when deploying indoor cellular wireless or Wi-Fi networks into suspended ceilings. The enclosures fit a standard ceiling tile space.

- Space-saving coverage – Design allows up to four small cell radio nodes to be securely mounted in suspended ceilings
- Easy Equipment Access – Adjustable-depth, swing-down mounting plate provides easy access and maintenance of equipment
- Effective Airflow – Vented door and large aluminum surface area for natural convection heat transfer without fans

Specifications:

- Dimensions:
 - Ceiling Enclosure with dome insert on door: 4.5"H x 23.8"W x 23.8"D (114 mm x 604 mm x 604 mm); Dome is 1.9"H (48.3 mm)
 - Ceiling Enclosure with flat vented door: 6.5"H x 23.8"W x 23.8"D (165 mm x 604 mm x 604 mm)
- Replaces 2' x 2' (0.6 m x 0.6 m) ceiling tiles
- (6) back-box knockouts for trade size 1" (25.4 mm) conduit
- Back Plate: 19.5"H x 19.5"W (495.3 mm x 495.3 mm); predrilled
- Equipment Usable Area: 19.5"H x 19.5"W x 4"D (495.3 mm x 495.3 mm x 101.6 mm)
- Cable Opening:
 - (2) prepunched duplex outlet knockouts on the top of the back-box for power or network connections.
 - (6) prepunched 1" (25.4 mm) knockouts for cable access along the side of the back-box (3 per side)
 - Includes (4) 1" (25.4 mm) firestop grommets for cable openings in back-box
- Construction:
 - 10 gauge aluminum back-box and flange, 10 gauge aluminum door. Optional plastic dome insert or prepunched antenna openings. Swing-down mounting panel is galvanized steel
- Door: Fully hinged locking door, available with dome insert or as a flat vented door
- Dome Insert: Vented UL 94-5VA ABS Plastic dome
- Load Rating: 25 lbs (11.4 kg)
- Finish: Powder coated, White

Certifications:

- UL 2416, Audio/Video, Information and Communication Technology Equipment Cabinet, Enclosure & Rack Systems
- CSA C22.2 NO. 60950-1-07 + Amd. 1 Amd. 2 Information Technology Equipment – Safety, Part 1, General Requirements
- RoHS

Includes:

- Enclosure with specified door
- Adjustable-depth, swing-down mounting plate
- (4) Dual Cable Egress Firestop Grommets
- (4) 1" (25.4 mm) diameter Conduit Connectors
- (8) Hanger Wires
- (2) Keys
- Grounding Screw

Accommodates:

- CommScope® ONECELL®
- Corning® SpiderCloud®
- Ericsson® Radio Dot
- Huawei® LampSite®
- Nokia® AirScale®
- Sunwave® CrossFire®
- Other small cell nodes may fit, check equipment usable area

| Part Number | Description | Shipping Weight lb (kg) |
|-------------|---|-------------------------|
| 52022-960 | Door with Dome; 4.5"H x 23.75"W x 23.75"D (114 mm x 604 mm x 604 mm) | 28 (12.7) |
| 52022-961 | Flat, Vented Door; 6.5"H x 23.75"W x 23.75"D (165 mm x 604 mm x 604 mm) | 28 (12.7) |



Accommodates:

- CommScope® ONECELL®
- Corning® SpiderCloud®
- Ericsson® Radio Dot
- Huawei® LampSite®
- Nokia® AirScale®
- Sunwave® CrossFire®
- Other small cell nodes may fit, check equipment usable area

RMR Bollards

RMR Bollards provide heavy-duty protection for small cell radio nodes, access points (APs), antennas and small switches located in outdoor and public spaces, where wireless coverage is most needed.

- Outdoor Wireless Coverage – Fiberglass construction is virtually transparent to wireless signal
- Universal Compatibility - Large enough for most vendors' radio nodes or access points, dipole or panel antennas, outdoor-rated network switches, media converters and PoE injectors
- Environmental Protection – Designed to meet NEMA Type 3R rating, protects equipment from tampering and weather

Specifications:

Cylindrical fiberglass bollard designed to protect access points and antennas in outdoor public spaces.

- Dimensions:
 - Bollard Cylinder: 57"H x 13" (1448 mm x 330 mm) diameter
 - Inner diameter: 12.5" (318 mm)
 - Anchor base: 15.3" H x 15.3" W (388.6 mm x 388.6 mm)
 - Bolt Cover: 15.3"H x 15.3"W x 4"D (388.6 mm x 388.6 mm x 102 mm)
- Back Plate:
 - Equipment mounting bracket: 11.5"H x 5.7"W (292.1 mm x 144.8 mm)
 - Right angle equipment bracket: 4.5"H x 5"W x 1.5"D (114 mm x 127 mm x 38 mm)
- Equipment Usable Area: 12.5" (317.5 mm) diameter; 8" (203.2 mm) from antenna mast to inner ridge.
- Cable Opening: 5" (127 mm) diameter opening for conduit in the anchor base
- Construction:
 - Bollard Cylinder: 1/4" (6.4 mm) thick centrifugal cast fiberglass composite bollard (65% glass, 35% resin)
 - Anchor base: Zinc coated, 1/4" (6.4 mm) thick steel
 - Equipment-mounting stand: Fiberglass pole and steel hardware
 - Bolt Cover: color-matched ABS plastic
- Load Rating: 25 lbs (11.4 kg)
- Cover: Bollard tube and cover, solid
- Finish: UV and cleaning chemical-resistant paint in Black, Brown, Forest Green, Gray, Light Gray and White

Includes:

- Fiberglass Bollard
- Thermoplastic ABS bolt cover
- G90 galvanized steel anchor base
- Wi-Fi decal
- T-Bar bracket
- Right angle equipment bracket
- Equipment mounting bracket
- (4) 3/8" bolts
- (2) 1/4-20 Hex Pin in Bit Tamper resistant screws
- (3) #10-32 Flat Head screws
- (4) #8-32 screws
- (2) 1-7/16" clamping U-bolt
- 1.25" fiberglass equipment pole
- 1.25" pole fitting

| Part Number | Description | Shipping Weight lb (kg) |
|-------------|-------------------------|-------------------------|
| 52023-910 | RMR Bollard, Black | 73 (33.1) |
| 52023-920 | RMR Bollard, Brown | 73 (33.1) |
| 52023-930 | RMR Bollard, Green | 73 (33.1) |
| 52023-940 | RMR Bollard, Gray | 73 (33.1) |
| 52023-950 | RMR Bollard, Light Gray | 73 (33.1) |
| 52023-960 | RMR Bollard, White | 73 (33.1) |



AAT-WMESG-P



AAT-WME-P



AAT-MWME-P

RMR Wireless Wall-Mount Enclosures

RMR Wireless Wall-Mount Enclosures provide NEMA protection for small cell radio nodes or wireless access points (APs) located in warehouses, manufacturing floors and outdoor spaces.

- **Signal Performance** – Rugged fiberglass reinforced polyester material does not interfere with wireless signals
- **Environmental Protection** – Enclosures are UL Type and NEMA Type rated for indoor and outdoor spaces
- **Equipment Support** – Removable back plate is prepunched to accommodate a variety of small cell radio nodes or wireless APs

Specifications:

Wall-mount enclosure for small cell radio nodes or wireless access points designed for warehouse, manufacturing/light industrial and exterior use

- **Dimensions:**
 - Large enclosure: 15.5"H x 13.5"W x 6"D (393.7 mm x 342.9 mm x 152.4 mm)
 - Small enclosure: 11.5"H x 9.5"W x 4.5"D (292.1 mm x 241.3 mm x 114.3 mm)
- **Back Plate:**
 - Large enclosure: 13-1/4"H x 11-1/8"W (330.2 mm x 279.4 mm), predrilled
 - Small enclosure: 8-7/8"H x 6-7/8"W (203.2 mm x 152.4 mm), predrilled
- **Internal Usable Area:**
 - Large enclosure: 13.5"H x 11.5"W x 5"D (342.9 mm x 292.1 mm x 127 mm)
 - Small enclosure: 9"H x 7"W x 3"D (228.6 mm x 177.8 x 76.2 mm)
- **Door:** Two styles: Solid and semi-transparent plexi-viewing window
- **Locking Mechanism:** Continuous steel hinge with stainless steel padlock hasps; Small enclosures include 1 hasp, large enclosures include 2 hasps
- **Material:**
 - Body: Fiberglass reinforced polyester
 - Back plate: Acrylic plastic
 - Hinge & Padlock Hasp: Stainless steel
- **Color** Gray

Certifications:

- UL Listed - for use with industrial equipment in ordinary locations
- Enclosures meet NEMA Type 1, 2, 3, 3R, 4, 4X, 12, and 13

| Part Number | Description | Shipping Weight lb (kg) |
|-------------|---|-------------------------|
| AAT-WME-P | Large Enclosure, Solid Door, Gray | 10 (4.5) |
| AAT-WMESG-P | Large Enclosure, Plexi Viewing Door, Gray | 10 (4.5) |
| AAT-MWME-P | Small Enclosure, Solid Door, Gray | 6 (2.7) |



SECTION 7

POWER MANAGEMENT PRODUCTS

| | | | |
|----------------------------------|------|---|------|
| eConnect® PDU Features | 7-3 | eConnect RFID Electronic Lock Kit | 7-25 |
| Basic eConnect PDU | 7-6 | Power IQ® for eConnect PDUs | 7-26 |
| Metered eConnect PDU | 7-10 | Power Receptacles | 7-27 |
| Monitored eConnect PDU | 7-12 | Power Strips | 7-28 |
| Monitored Pro eConnect PDU | 7-16 | International Power Strips | 7-30 |
| Switched eConnect PDU | 7-19 | Power Accessories | 7-34 |
| Switched Pro eConnect PDU | 7-22 | | |

Learn about CPI's Extended Limited Warranties for coverage of (2) additional years beyond the expiration of the Standard Limited Warranty Period. See page vi.

POWER MANAGEMENT PRODUCTS

Section Update:

- Next-Generation eConnect® Horizontal PDUs:
 - Basic eConnect PDU Page 7-6
 - Monitored eConnect PDU Page 7-12

Where Can I Learn More?

To learn more about CPI's Power Management Products, or to find additional part numbers not listed in this catalog, please visit our website, chatsworth.com

Related Tools:

Use these tools, under the Resources tab on chatsworth.com, to simplify your planning, selection, order and purchase of CPI Power Management Products.

- BIM Drawings
- CPI Power Selector
- eConnect® Secure Array® Savings Estimator
- eConnect Online Demo
- Software

Your Notes Here:

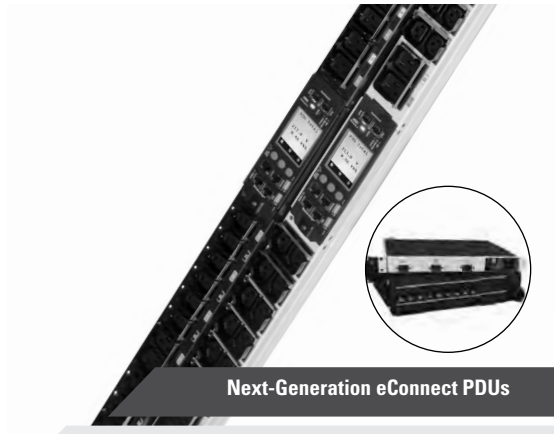

CPI's Intelligent eConnect Vertical PDUs

Available in over 350 standard configurations—provide users with a variety of high-performance features and benefits that can help solve application needs from big to small, low to high density and in traditional or nontraditional environments.

No other PDU offers the broad application versatility of CPI's eConnect PDUs. Designed to simplify deployment, installation and service, eConnect PDUs have helped to power and protect ICT equipment in countless applications and sites thanks to CPI's industry wide high performance and reliability.

Use Vertical eConnect PDUs in data centers and equipment rooms with 42U or higher racks, cabinets and enclosures to provide power connections alongside equipment for higher-density applications. Use Redundancy Pack to support redundant power circuits.



Hydraulic-Magnetic Breakers



Color-coded Labels Printed on Metal



Status LED Light



Field-Replaceable Controller Module

Note: Basic Vertical eConnect PDUs do not have Field-Replaceable Modules



Locking Outlets



- 1 Proprietary Auxiliary Ports for Lock Kits
- 2 Serial Console port - USB Mini Type B
- 3 Status LED
- 4 Ethernet port - RJ45
- 5 Serial Console port - RJ45
- 6 USB Type A ports for Firmware and Temperature/ Humidity Sensors
- 7 Secure Array Ports - RJ45 - for linking of up to 48 PDUs
- 8 LCD Local Display

CPI's Intelligent eConnect Horizontal PDUs

Use Horizontal eConnect PDUs in applications that require outlets at the top or bottom of cabinets for quick access, low- to medium-density applications that require fewer connections and in distributed infrastructure for edge applications. Horizontal PDUs are available in 1U and 2U heights with up to 24 outlets.



Note: Basic Horizontal eConnect PDUs do not have Field-Replaceable Modules



Preinstalled Adjustable Depth Mounting Brackets



Hydraulic-Magnetic Breakers



Field-Replaceable Controller Module



Locking Outlets

Field-Replaceable Controller Module

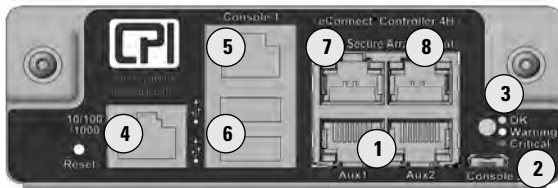

Note: Horizontal eConnect PDUs do not have a LCD Local Display.

- 1 Proprietary Auxiliary Ports
- 2 Console 2 Port - USB
- 3 Status LED
- 4 Ethernet Port - RJ45
- 5 Console 1 Port - RJ45
- 6 USB Type A Ports for Firmware and Temperature/Humidity Sensors
- 7 Secure Array/PDU Linking/Serial Port (link-in)
- 8 Secure Array/PDU Linking/Serial Port (link-out)

eConnect PDU Selection Guide

The first step when selecting a rack PDU is to identify the level of functionality. The chart below summarizes the monitoring and control differences.

| eConnect Model | Basic Power Distribution | Inlet Metering | Branch Circuit Metering | Remote Access | Access Control | Outlet Metering | Switched Outlets |
|----------------------|--------------------------|----------------|-------------------------|---------------|----------------|-----------------|------------------|
| Basic | ✓ | | | | | | |
| Metered | ✓ | ✓ | | | | | |
| Monitored | ✓ | ✓ | ✓ | ✓ | ✓ | | |
| Monitored Pro | ✓ | ✓ | ✓ | ✓ | ✓ | ✓ | |
| Switched | ✓ | ✓ | ✓ | ✓ | ✓ | | ✓ |
| Switched Pro | ✓ | ✓ | ✓ | ✓ | ✓ | ✓ | ✓ |



The Power Selector enables you to select the best power product for your application by narrowing down options based on your requirements. After you're done comparing, you can email or print the results. Visit selectapdu.com to access the Power Selector.



Vertical and Horizontal Options Available



Basic eConnect PDUs provide reliable power distribution in high-density applications where no power monitoring is required.

Resistance to High Temperature

Market-leading temperature ratings of up to 149°F (65°C) ensures reliability when mounted toward hot aisles

Simplified Load Balancing

Phase-balance outlets on three-phase models ensure equal loading across all phases; allows use of shorter equipment power cords for better cable and airflow management

No Accidental Disconnections

Patented, low-profile locking outlets prevent accidental disconnections without requiring special cords

Easy Identification of Failover Unit

Redundancy Pack includes 2 PDUs (one in Black and one in Glacier White) for easy identification of the primary and secondary unit

Latest UL Compliance

Meets UL and IEC 62368 for compliance with new listing requirements for North America and the European Union

Cabinet Preinstallation

Complete ecosystem ships ready for IT equipment integration. Saves deployment time and reduces packaging waste.

Basic eConnect PDU

Additional Features:

- Breaker and outlet groups are color-coded in multi-breaker units for easy identification
- Universal tool-less mounting features
- Customization capabilities: outlet configurations, color options, power cord length, input connection types and more
- Made in the United States, TAA-compliant

Specifications:

- Single-input, vertical and horizontal rack-mount PDUs
- Circuit Protection:
 - UL 489 listed, single- or two-pole, hydraulic-magnetic breakers available on single- and three-phase models with 30A and above input
 - 10kAIC breakers on 220-240/380-415 VAC models; 5kAIC for all other models
 - Low-profile design prevents accidental discharge
- Power Output:
 - Alternating current, 50/60 Hz, 10' (3 m) input power cord
 - Voltage, maximum current, and inlet/plug type varies per model (see ordering table)
- Power Output:
 - NEMA 5-20R, Locking IEC C13 and/or IEC C19 Outlets, specific to PDU with up to 54 outlets (see order table)
- Mounting:
 - Vertical PDUs: 2 preinstalled tool-less mounting buttons; adjustable positions; Top or bottom power cord entry orientation
 - Horizontal PDUs: Include rack-mount brackets for 19"EIA (482.6 mm) racks
- Bonding/Grounding:
 - Bonded power inlet/plug and external bond connection with a threaded M5 attachment point
 - Includes a bonding kit for CPI cabinets
- Operating Conditions:
 - Temperature: 32°F – 149°F (0°C – 65°C) at Input Power Rating (kW)
 - Relative Humidity: 5% – 95%, noncondensing
 - Elevation: 0 – 10,000 ft (0 – 3,000 m)
- Dimensions:
 - For specific dimensions, download the individual product cut sheets by searching the base part number (ex: Ex-xxxx) on chatsworth.com

Certifications:

- UL/cUL/IEC62368, CE (EU), FCC Part 15, Class A, EN 55022, RoHS Compliant



The Power Selector enables you to select the best power product for your application by narrowing down options based on your requirements. After you're done comparing, you can email or print the results. Visit selectapdu.com to access the Power Selector.

| Basic eConnect PDU, Vertical - North America | | | | | | | | |
|--|----------------|-------------------|----------------|--------------------|-------------------------------|------------------|------------------|--|
| Part Number | | | Input Amperage | Input Plug | Outlets | kW Capacity (UL) | Cabinet Capacity | |
| Black* | Glacier White* | Redundancy Pack** | | | | | | |
| 120 Volt, Single-Phase Input | | | | | | | | |
| EO-1001-C | EO-1001-E | EO-1001-CE | 20A | C20 Inlet to L5-20 | (24) 5-20 | 1.9 kW | 42U & higher | |
| EO-1002-C | EO-1002-E | EO-1002-CE | 30A | L5-30 | (24) 5-20 | 2.9 kW | 42U & higher | |
| 208 Volt, Single-Phase Input | | | | | | | | |
| EO-1003-C | EO-1003-E | EO-1003-CE | 20A | C20 Inlet to L6-20 | (24) C13 | 3.3 kW | 42U & higher | |
| EO-1004-C | EO-1004-E | EO-1004-CE | 30A | L6-30 | (24) C13 | 5 kW | 42U & higher | |
| EO-1015-C | EO-1015-E | EO-1015-CE | 30A | L6-30 | (36) C13 + (6) C19 | 5 kW | 42U & higher | |
| 120/208 Volt, Three-Phase Input | | | | | | | | |
| EO-1013-C | EO-1013-E | EO-1013-CE | 20A | L21-20 | (30) C13 + (6) C19 + (6) 5-20 | 5.7 kW | 42U & higher | |
| EO-1017-C | EO-1017-E | EO-1017-CE | 20A | L21-20 | (36) C13 + (6) C19 | 5.7 kW | 42U & higher | |
| EO-1014-C | EO-1014-E | EO-1014-CE | 30A | L21-30 | (30) C13 + (6) C19 + (6) 5-20 | 8.6 kW | 42U & higher | |
| EO-1018-C | EO-1018-E | EO-1018-CE | 30A | L21-30 | (36) C13 + (6) C19 | 8.6 kW | 42U & higher | |
| 208 Volt, Three-Phase Input | | | | | | | | |
| EO-1016-C | EO-1016-E | EO-1016-CE | 30A | L15-30 | (36) C13 + (6) C19 | 8.6 kW | 42U & higher | |
| EO-1007-C | EO-1007-E | EO-1007-CE | 50A | CS8365 | (30) C13 + (12) C19 | 14.4 kW | 42U & higher | |
| EO-1019-C | EO-1019-E | EO-1019-CE | 50A | CS8365 | (36) C13 + (6) C19 | 14.4 kW | 42U & higher | |
| EO-1125-C | EO-1125-E | EO-1125-CE | 50A | CS8365 | (54) C13 | 14.4 kW | 45U & higher | |
| EO-1008-C | EO-1008-E | EO-1008-CE | 60A | IEC 60309 60A 3P+E | (30) C13 + (12) C19 | 17.2 kW | 42U & higher | |
| EO-1020-C | EO-1020-E | EO-1020-CE | 60A | IEC 60309 60A 3P+E | (36) C13 + (6) C19 | 17.2 kW | 42U & higher | |
| EO-1033-C | EO-1033-E | EO-1033-CE | 60A | IEC 60309 60A 3P+E | (12) C13 + (18) C19 | 17.2 kW | 42U & higher | |
| EO-1126-C | EO-1126-E | EO-1126-CE | 60A | IEC 60309 60A 3P+E | (54) C13 | 17.2 kW | 45U & higher | |
| 240/415 Volt, Three-Phase Input | | | | | | | | |
| EO-1021-C | EO-1021-E | EO-1021-CE | 30A | L22-30 | (36) C13 + (6) C19 | 17.2 kW | 42U & higher | |
| EO-1127-C | EO-1127-E | EO-1127-CE | 30A | L22-30 | (54) C13 | 17.2 kW | 45U & higher | |

| Basic eConnect PDU, Vertical - Worldwide | | | | | | | | |
|--|----------------|-------------------|----------------|-----------------------------------|---------------------|----------------------------|--------------------------------|------------------|
| Part Number | | | Input Amperage | Input Plug | Outlets | kW Capacity Worldwide (CE) | kW Capacity North America (UL) | Cabinet Capacity |
| Black* | Glacier White* | Redundancy Pack** | | | | | | |
| 220 - 240 Volt, Single-Phase Input | | | | | | | | |
| EO-1005-C | EO-1005-E | EO-1005-CE | 16A | C20 Inlet to IEC 60309 16A 1P+N+E | (24) C13 | 3.8 kW | 3.8 kW | 42U & higher |
| EO-1006-C | EO-1006-E | EO-1006-CE | 32A | IEC 60309 32A 1P+N+E | (24) C13 | 7.7 kW | 6.1 kW | 42U & higher |
| EO-1022-C | EO-1022-E | EO-1022-CE | 32A | IEC 60309 32A 1P+N+E | (36) C13 + (6) C19 | 7.7 kW | 6.1 kW | 42U & higher |
| 220-240/380-415 Volt, Three-Phase Input | | | | | | | | |
| EO-1023-C | EO-1023-E | EO-1023-CE | 16/20A | IEC 60309 16/20A 3P+N+E | (36) C13 + (6) C19 | 11.5 kW | 11.5 kW | 42U & higher |
| EO-1009-C | EO-1009-E | EO-1009-CE | 32A | IEC 60309 32A 3P+N+E | (36) C13 + (12) C19 | 23 kW | 18.4 kW | 42U & higher |
| EO-1024-C | EO-1024-E | EO-1024-CE | 32A | IEC 60309 32A 3P+N+E | (36) C13 + (6) C19 | 23 kW | 18.4 kW | 42U & higher |
| EO-1128-C | EO-1128-E | EO-1128-CE | 32A | IEC 60309 32A 3P+N+E | (54) C13 | 23 kW | 18.4 kW | 45U & higher |

Notes: * Shipping weight for each unit is 27 lb (12 kg). **Redundancy Pack includes 2 PDUs in Black and Glacier White for easy identification of the primary and secondary unit; shipping weight is 54 lb (24 kg).

| Basic eConnect PDU, Horizontal - North America | | | | | | | | |
|--|-------------------|----------------|----------------|--------------------|-------------------|------------------|------------------------|--------|
| Part Number | | | Input Amperage | Input Plug | Outlets | kW Capacity (UL) | Form Factor (U) Height | Black* |
| Glacier White* | Redundancy Pack** | Glacier White* | | | | | | |
| 120 Volt, Single-Phase Input | | | | | | | | |
| E0-1243-C | E0-1243-E | E0-1243-CE | 20A | C20 Inlet to L5-20 | (12) 5-20 | 1.9 kW | 1U | |
| E0-1244-C | E0-1244-E | E0-1244-CE | 30A | NEMA L5-30P | (12) 5-20 | 2.9 kW | 1U | |
| 208 Volt, Single-Phase Input | | | | | | | | |
| E0-1245-C | E0-1245-E | E0-1245-CE | 20A | C20 Inlet to L6-20 | (12) C13 | 3.3 kW | 1U | |
| E0-1270-C | E0-1270-E | E0-1270-CE | 20A | C20 Inlet to L6-20 | (8) C13 + (4) C19 | 3.3 kW | 1U | |
| E0-1246-C | E0-1246-E | E0-1246-CE | 30A | NEMA L6-30P | (12) C13 | 5 kW | 1U | |
| E0-1253-C | E0-1253-E | E0-1253-CE | 30A | NEMA L6-30P | (9) C19 | 5 kW | 1U | |
| E0-1271-C | E0-1271-E | E0-1271-CE | 30A | NEMA L6-30P | (8) C13 + (4) C19 | 5 kW | 1U | |
| 120/208 Volt, Three-Phase Input | | | | | | | | |
| E0-1248-C | E0-1248-E | E0-1248-CE | 20A | NEMA L21-20P | (12) C13 | 5.7 kW | 1U | |
| E0-1255-C | E0-1255-E | E0-1255-CE | 20A | NEMA L21-20P | (9) C19 | 5.7 kW | 1U | |
| E0-1273-C | E0-1273-E | E0-1273-CE | 20A | NEMA L21-20P | (8) C13 + (4) C19 | 5.7 kW | 1U | |
| E0-1249-C | E0-1249-E | E0-1249-CE | 30A | NEMA L21-30P | (12) C13 | 8.6 kW | 1U | |
| E0-1256-C | E0-1256-E | E0-1256-CE | 30A | NEMA L21-30P | (9) C19 | 8.6 kW | 1U | |
| E0-1274-C | E0-1274-E | E0-1274-CE | 30A | NEMA L21-30P | (8) C13 + (4) C19 | 8.6 kW | 1U | |
| 208 Volt, Three-Phase Input | | | | | | | | |
| E0-1247-C | E0-1247-E | E0-1247-CE | 30A | NEMA L15-30P | (12) C13 | 8.6 kW | 1U | |
| E0-1254-C | E0-1254-E | E0-1254-CE | 30A | NEMA L15-30P | (9) C19 | 8.6 kW | 1U | |
| E0-1272-C | E0-1272-E | E0-1272-CE | 30A | NEMA L15-30P | (8) C13 + (4) C19 | 8.6 kW | 1U | |

| Basic eConnect PDU, Horizontal - Worldwide | | | | | | | | | |
|--|-------------------|----------------|----------------|-----------------------------------|-------------------|------------------|--------------------------------|------------------------|--------|
| Part Number | | | Input Amperage | Input Plug | Outlets | kW Capacity (UL) | kW Capacity North America (UL) | Form Factor (U) Height | Black* |
| Glacier White* | Redundancy Pack** | Glacier White* | | | | | | | |
| 220 - 240 Volt, Single-Phase Input | | | | | | | | | |
| E0-1250-C | E0-1250-E | E0-1250-CE | 16A | C20 Inlet to IEC 60309 16A 1P+N+E | (12) C13 | 3.8 kW | 3.8 kW | 1U | |
| E0-1275-C | E0-1275-E | E0-1275-CE | 16A | C20 Inlet to IEC 60309 16A 1P+N+E | (8) C13 + (4) C19 | 3.8 kW | 3.8 kW | 1U | |
| E0-1252-C | E0-1252-E | E0-1252-CE | 32A | IEC 60309 32A 1P+N+E | (12) C13 | 7.7 kW | 6.1 kW | 1U | |
| E0-1257-C | E0-1257-E | E0-1257-CE | 32A | IEC 60309 32A 1P+N+E | (9) C19 | 7.7 kW | 6.1 kW | 1U | |
| E0-1277-C | E0-1277-E | E0-1277-CE | 32A | IEC 60309 32A 1P+N+E | (8) C13 + (4) C19 | 7.7 kW | 6.1 kW | 1U | |
| 220 - 240/380-415 Volt, Three-Phase Input | | | | | | | | | |
| E0-1251-C | E0-1251-E | E0-1251-CE | 16/20A | IEC 60309 16/20A 3P+N+E | (12) C13 | 11.5 kW | 11.5 kW | 1U | |
| E0-1258-C | E0-1258-E | E0-1258-CE | 16/20A | IEC 60309 16/20A 3P+N+E | (9) C19 | 11.5 kW | 11.5 kW | 1U | |
| E0-1276-C | E0-1276-E | E0-1276-CE | 16/20A | IEC 60309 16/20A 3P+N+E | (8) C13 + (4) C19 | 11.5 kW | 11.5 kW | 1U | |

Notes: * Shipping weight for each unit is 18 lb (8.2 kg); **Redundancy Pack includes 2 PDUs in Black and Glacier White for easy identification of the primary and secondary unit; shipping weight is 35 lb (15.9 kg)



The Power Selector enables you to select the best power product for your application by narrowing down options based on your requirements. After you're done comparing, you can email or print the results. Visit selectapdu.com to access the Power Selector.

| Basic eConnect PDU, Horizontal - North America | | | | | | | | | |
|---|----------------|-------------------|----------------|-----------------------------------|-------------------------------|------------------|--------------------------------|------------------------|--|
| Part Number | | | Input Amperage | Input Plug | Outlets | kW Capacity (UL) | Form Factor (U) Height | | |
| Black* | Glacier White* | Redundancy Pack** | | | | | | | |
| 120 Volt, Single-Phase Input | | | | | | | | | |
| EO-1401-C | EO-1401-E | EO-1401-CE | 20A | C20 Inlet to L5-20 | (24) 5-20 | 1.9 kW | | 2U | |
| EO-1402-C | EO-1402-E | EO-1402-CE | 30A | NEMA L5-30P | (24) 5-20 | 2.9 kW | | 2U | |
| 208 Volt, Single-Phase Input | | | | | | | | | |
| EO-1403-C | EO-1403-E | EO-1403-CE | 20A | C20 Inlet to L6-20 | (24) C13 | 3.3 kW | | 2U | |
| EO-1459-C | EO-1459-E | EO-1459-CE | 20A | C20 Inlet to L6-20 | (18) C13 + (6) C19 | 3.3 kW | | 2U | |
| EO-1404-C | EO-1404-E | EO-1404-CE | 30A | NEMA L6-30P | (24) C13 | 5 kW | | 2U | |
| EO-1461-C | EO-1461-E | EO-1461-CE | 30A | NEMA L6-30P | (18) C13 + (6) C19 | 5 kW | | 2U | |
| EO-1478-C | EO-1478-E | EO-1478-CE | 30A | NEMA L6-30P | (6) C13 + (12) C19 | 5 kW | | 2U | |
| 120/208 Volt, Single-Phase Input | | | | | | | | | |
| EO-1469-C | EO-1469-E | EO-1469-CE | 30A | NEMA L14-30P | (12) C13 + (6) C19 + (4) 5-20 | 5 kW | | 2U | |
| 120/208 Volt, Three-Phase Input | | | | | | | | | |
| EO-1439-C | EO-1439-E | EO-1439-CE | 20A | NEMA L21-20P | (24) C13 | 5.7 kW | | 2U | |
| EO-1463-C | EO-1463-E | EO-1463-CE | 20A | NEMA L21-20P | (18) C13 + (6) C19 | 5.7 kW | | 2U | |
| EO-1480-C | EO-1480-E | EO-1480-CE | 20A | NEMA L21-20P | (6) C13 + (12) C19 | 5.7 kW | | 2U | |
| EO-1467-C | EO-1467-E | EO-1467-CE | 20A | NEMA L21-20P | (12) C13 + (6) C19 + (4) 5-20 | 5.7 kW | | 2U | |
| EO-1440-C | EO-1440-E | EO-1440-CE | 30A | NEMA L21-30P | (24) C13 | 8.6 kW | | 2U | |
| EO-1464-C | EO-1464-E | EO-1464-CE | 30A | NEMA L21-30P | (18) C13 + (6) C19 | 8.6 kW | | 2U | |
| EO-1482-C | EO-1482-E | EO-1482-CE | 30A | NEMA L21-30P | (6) C13 + (12) C19 | 8.6 kW | | 2U | |
| EO-1468-C | EO-1468-E | EO-1468-CE | 30A | NEMA L21-30P | (12) C13 + (6) C19 + (4) 5-20 | 8.6 kW | | 2U | |
| 208 Volt, Three-Phase Input | | | | | | | | | |
| EO-1441-C | EO-1441-E | EO-1441-CE | 30A | NEMA L15-30P | (24) C13 | 8.6 kW | | 2U | |
| EO-1465-C | EO-1465-E | EO-1465-CE | 30A | NEMA L15-30P | (18) C13 + (6) C19 | 8.6 kW | | 2U | |
| EO-1483-C | EO-1483-E | EO-1483-CE | 30A | NEMA L15-30P | (6) C13 + (12) C19 | 8.6 kW | | 2U | |
| EO-1484-C | EO-1484-E | EO-1484-CE | 50A | CS8365 | (6) C13 + (12) C19 | 14.4 kW | | 2U | |
| EO-1485-C | EO-1485-E | EO-1485-CE | 60A | IEC 60309 60A 3P+E | (6) C13 + (12) C19 | 17.2 kW | | 2U | |
| Basic eConnect PDU, Horizontal - Worldwide | | | | | | | | | |
| Part Number | | | Input Amperage | Input Plug | Outlets | kW Capacity (UL) | kW Capacity North America (UL) | Form Factor (U) Height | |
| Black* | Glacier White* | Redundancy Pack** | | | | | | | |
| 220 - 240 Volt, Single-Phase Input | | | | | | | | | |
| EO-1405-C | EO-1405-E | EO-1405-CE | 16A | C20 Inlet to IEC 60309 16A 1P+N+E | (24) C13 | 3.8 kW | 3.8 kW | 2U | |
| EO-1460-C | EO-1460-E | EO-1460-CE | 16A | C20 Inlet to IEC 60309 16A 1P+N+E | (18) C13 + (6) C19 | 3.8 kW | 3.8 kW | 2U | |
| EO-1406-C | EO-1406-E | EO-1406-CE | 32A | IEC 60309 32A 1P+N+E | (24) C13 | 7.7 kW | 6.1 kW | 2U | |
| EO-1462-C | EO-1462-E | EO-1462-CE | 32A | IEC 60309 32A 1P+N+E | (18) C13 + (6) C19 | 7.7 kW | 6.1 kW | 2U | |
| EO-1479-C | EO-1479-E | EO-1479-CE | 32A | IEC 60309 32A 1P+N+E | (6) C13 + (12) C19 | 7.7 kW | 6.1 kW | 2U | |
| 220 - 240/380-415 Volt, Three-Phase Input | | | | | | | | | |
| EO-1442-C | EO-1442-E | EO-1442-CE | 16/20A | IEC 60309 16/20A 3P+N+E | (24) C13 | 11.5 kW | 11.5 kW | 2U | |
| EO-1466-C | EO-1466-E | EO-1466-CE | 16/20A | IEC 60309 16/20A 3P+N+E | (18) C13 + (6) C19 | 11.5 kW | 11.5 kW | 2U | |
| EO-1481-C | EO-1481-E | EO-1481-CE | 16/20A | IEC 60309 16/20A 3P+N+E | (6) C13 + (12) C19 | 11.5 kW | 11.5 kW | 2U | |
| EO-1486-C | EO-1486-E | EO-1486-CE | 32A | IEC 60309 32A 3P+N+E | (6) C13 + (12) C19 | 23 kW | 18.4 kW | 2U | |

Notes: * Shipping weight for each unit is 23 lb (10.4 kg); **Redundancy Pack includes 2 PDUs in Black and Glacier White for easy identification of the primary and secondary unit; shipping weight is 45 lb (20.4 kg)



Metered eConnect PDUs feature a local display for easy reading of input current to help with initial installation and properly balanced operations.

Resistance to High Temperature

Market-leading temperature ratings of up to 149°F (65°C) ensures reliability when mounted toward hot aisles

Simplified Load Balancing

Phase-balance outlets on three-phase models ensure equal loading across all phases; allows use of shorter equipment power cords for better cable and airflow management

No Accidental Disconnections

Patented, low-profile locking outlets prevent accidental disconnections without requiring special cords

Easy Identification of Failover Unit

Redundancy Pack includes 2 PDUs (one in Black and one in Glacier White) for easy identification of the primary and secondary unit

Latest UL Compliance

Meets UL and IEC 62368 for compliance with new listing requirements for North America and the European Union

Cabinet Preinstallation

Complete ecosystem ships ready for IT equipment integration. Saves deployment time and reduces packaging waste.

Metered eConnect PDU

Additional Features:

- Input current metering across phases through LED display
- Breakers and outlet groups are color-coded in multi-breaker units for easy identification
- Universal tool-less mounting features
- Customization capabilities: outlet configurations, color options, power cord length, input connection types and more
- Made in the United States, TAA-compliant

Specifications:

- Circuit Protection:
 - UL 489 listed, single- or two-pole, hydraulic-magnetic breakers available on single- and three-phase models with 30A and above input
 - 10kAIC breakers on 220-240/380-415 VAC models; 5kAIC for all other models
 - Low-profile design prevents accidental discharge
- Metering
 - Input line currents
 - Display: 4-digit LED, displays input current for all phases; typical accuracy of +/-2%
- Power Output:
 - Alternating current, 50/60 Hz, 10' (3 m) input power cord
 - Voltage, maximum current, and inlet/plug type varies per model (see ordering table)
- Power Output:
 - NEMA 5-20R, Locking IEC C13 and/or IEC C19 Outlets, specific to PDU with up to 54 outlets (see order table)
- Mounting:
 - 2 preinstalled toolless mounting buttons; adjustable positions
 - Top or bottom power cord entry orientation
- Bonding/Grounding
 - Bonded power inlet/plug and external bond connection with a threaded M5 attachment point
 - Includes a bonding kit for CPI cabinets
- Operating Conditions:
 - Temperature: 32°F – 149°F (0°C – 65°C) at Input Power Rating (kW)
 - Relative Humidity: 5% – 95%, noncondensing
 - Elevation: 0 – 10,000 ft (0 – 3,000 m)
 - Dimensions:
 - For specific dimensions, download the individual product cut sheets by searching the base part number (ex: Ex-xxxx) on chatsworth.com

Certifications:

- UL/cUL/IEC62368, CE (EU), FCC Part 15, Class A, EN 55022, RoHS Compliant



The Power Selector enables you to select the best power product for your application by narrowing down options based on your requirements. After you're done comparing, you can email or print the results. Visit selectapdu.com to access the Power Selector.

| Metered eConnect PDU, Vertical - North America | | | | | | | |
|--|----------------|-------------------|----------------|--------------------|-------------------------------|------------------|--------------------|
| Part Number | | | Input Amperage | Input Plug | Outlets | kW Capacity (UL) | Cabinet Capability |
| Black* | Glacier White* | Redundancy Pack** | | | | | |
| 120 Volt, Single-Phase Input | | | | | | | |
| E1-2001-C | E1-2001-E | E1-2001-CE | 20A | C20 Inlet to L5-20 | (24) 5-20 | 1.9 kW | 42U & higher |
| E1-2002-C | E1-2002-E | E1-2002-CE | 30A | L5-30 | (24) 5-20 | 2.9 kW | 42U & higher |
| 208 Volt, Single-Phase Input | | | | | | | |
| E1-2003-C | E1-2003-E | E1-2003-CE | 20A | C20 Inlet to L6-20 | (24) C13 | 3.3 kW | 42U & higher |
| E1-2004-C | E1-2004-E | E1-2004-CE | 30A | L6-30 | (24) C13 | 5 kW | 42U & higher |
| E1-2015-C | E1-2015-E | E1-2015-CE | 30A | L6-30 | (36) C13 + (6) C19 | 5 kW | 42U & higher |
| 208 Volt, Three-Phase Input | | | | | | | |
| E1-2016-C | E1-2016-E | E1-2016-CE | 30A | L15-30 | (36) C13 + (6) C19 | 8.6 kW | 42U & higher |
| E1-2007-C | E1-2007-E | E1-2007-CE | 50A | CS8365 | (30) C13 + (12) C19 | 14.4 kW | 42U & higher |
| E1-2019-C | E1-2019-E | E1-2019-CE | 50A | CS8365 | (36) C13 + (6) C19 | 14.4 kW | 42U & higher |
| E1-2125-C | E1-2125-E | E1-2125-CE | 50A | CS8365 | (54) C13 | 14.4 kW | 45U & higher |
| E1-2008-C | E1-2008-E | E1-2008-CE | 60A | IEC 60309 60A 3P+E | (30) C13 + (12) C19 | 17.2 kW | 42U & higher |
| E1-2020-C | E1-2020-E | E1-2020-CE | 60A | IEC 60309 60A 3P+E | (36) C13 + (6) C19 | 17.2 kW | 42U & higher |
| E1-2126-C | E1-2126-E | E1-2026-CE | 60A | IEC 60309 60A 3P+E | (54) C13 | 17.2 kW | 45U & higher |
| E1-2033-C | E1-2033-E | E1-2033-CE | 60A | IEC 60309 60A 3P+E | (12) C13 + (18) C19 | 17.2 kW | 42U & higher |
| 120/208 Volt, Three-Phase Input | | | | | | | |
| E1-2013-C | E1-2013-E | E1-2013-CE | 20A | L21-20 | (30) C13 + (6) C19 + (6) 5-20 | 5.7 kW | 42U & higher |
| E1-2017-C | E1-2017-E | E1-2017-CE | 20A | L21-20 | (36) C13 + (6) C19 | 5.7 kW | 42U & higher |
| E1-2014-C | E1-2014-E | E1-2014-CE | 30A | L21-30 | (30) C13 + (6) C19 + (6) 5-20 | 8.6 kW | 42U & higher |
| E1-2018-C | E1-2018-E | E1-2018-CE | 30A | L21-30 | (36) C13 + (6) C19 | 8.6 kW | 42U & higher |
| 240/415 Volt, Three-Phase Input | | | | | | | |
| E1-2021-C | E1-2021-E | E1-2021-CE | 30A | L22-30 | (36) C13 + (6) C19 | 17.2 kW | 42U & higher |
| E1-2127-C | E1-2127-E | E1-2127-CE | 30A | L22-30 | (54) C13 | 17.2 kW | 45U & higher |

| Metered eConnect PDU, Vertical - Worldwide | | | | | | | | |
|--|----------------|-------------------|----------------|-----------------------------------|---------------------|----------------------------|--------------------------------|--------------------|
| Part Number | | | Input Amperage | Input Plug | Outlets | kW Capacity Worldwide (CE) | kW Capacity North America (UL) | Cabinet Capability |
| Black* | Glacier White* | Redundancy Pack** | | | | | | |
| 220 - 240 Volt, Single-Phase Input | | | | | | | | |
| E1-2005-C | E1-2005-E | E1-2005-CE | 16A | C20 Inlet to IEC 60309 16A 1P+N+E | (24) C13 | 3.8 kW | 3.8 kW | 42U & higher |
| E1-2006-C | E1-2006-E | E1-2006-CE | 32A | IEC 60309 32A 1P+N+E | (24) C13 | 7.7 kW | 6.1 kW | 42U & higher |
| E1-2022-C | E1-2022-E | E1-2022-CE | 32A | IEC 60309 32A 1P+N+E | (18) C13 + (6) C19 | 7.7 kW | 6.1 kW | 42U & higher |
| 220-240/380-415 Volt, Three-Phase Input | | | | | | | | |
| E1-2023-C | E1-2023-E | E1-2023-CE | 16/20A | IEC 60309 16/20A 3P+N+E | (36) C13 + (6) C19 | 11.5 kW | 11.5 kW | 42U & higher |
| E1-2009-C | E1-2009-E | E1-2009-CE | 32A | IEC 60309 32A 3P+N+E | (36) C13 + (12) C19 | 23 kW | 18.4 kW | 42U & higher |
| E1-2024-C | E1-2024-E | E1-2024-CE | 32A | IEC 60309 32A 3P+N+E | (36) C13 + (6) C19 | 23 kW | 18.4 kW | 42U & higher |
| E1-2128-C | E1-2128-E | E1-2128-CE | 32A | IEC 60309 32A 3P+N+E | (54) C13 | 23 kW | 18.4 kW | 45U & higher |

Notes: * Shipping weight for each unit is 27 lb (12 kg). **Redundancy Pack includes 2 PDUs in Black and Glacier White for easy identification of the primary and secondary unit; shipping weight is 54 lb (24 kg).



Vertical and Horizontal Options Available



Monitored eConnect PDUs provide remote power monitoring to the input and branch circuit level, making it possible to obtain and manage power consumption at the cabinet level.

Reduced Networking Costs and Complexity

Secure Array® allows the use of a single IP address for up to 48 connected PDUs (32 when electronic locks are integrated). Second IP address for the entire array provides failover capability

Simplified Load Balancing

Phase-balance outlets on three-phase models ensure equal loading across all phases; allows use of shorter equipment power cords for better cable and airflow management

No Accidental Disconnections

Patented, low-profile locking outlets prevent accidental disconnections without requiring special cords

Electronic Lock Integration

Patented technology seamlessly integrates PDU, environmental sensors and electronic locks into a single hardware and software solution

Gigabit Ethernet

Ensures compatibility with enterprise routers and switches

Cabinet Preinstallation

Complete ecosystem ships ready for IT equipment integration. Saves deployment time and reduces packaging waste.

Monitored eConnect PDU

Additional Features:

- Input and branch circuit monitoring with billing-grade +/-1% accuracy
- Field-replaceable controller module for easy serviceability and upgradeability while maintaining power to critical loads; SD-card transfers PDU configuration
- Onboard GUI, RESTful API, SNMP v1/v2/v3, Command Line Interface (CLI), and native Power IQ® DCIM software integration allows users to easily manage PDUs
- Zero Touch Provisioning (ZTP) automates configuration and provisioning of large deployments of PDUs.
- HTTPs support, RADIUS and LDAP integration for enhanced authentication and security
- Customization capabilities: outlet configurations, color options, power cord length, input connection types and more
- Made in the United States, TAA-compliant

Specifications:

- Single-input, vertical and horizontal rack-mount PDUs
- Circuit Protection:
 - UL 489 listed, single- or two-pole, hydraulic-magnetic breakers available on single- and three-phase models with 30A and above input
 - 10kAIC breakers on 220-240/380-415 VAC models; 5kAIC for all other models
 - Low-profile design prevents accidental discharge
- Metering:
 - Input line currents
 - Voltage, current, power, energy and power factor at branch circuits
 - +/- 1% billing-grade
- Networking:
 - 10/100/1000MB Ethernet Port
 - Secure Array IP Consolidation for up to 48 PDUs with no integrated electronic locks or 32 PDUs with integrated electronic locks
 - Secure Array IP Consolidation supports alternate/failover network connection through a second PDU
- Console Access:
 - Through serial console port connection and Command Line Interface (CLI)
- Controller:
 - Field-replaceable module; SD-card transfers PDU configuration
- Firmware:
 - Flash upgradeable through USB port, Web interface, CLI, API or PowerIQ
- Electronic Lock Integration:
 - Front and rear cabinet door locks (ordered separately) connected to AUX ports on the PDU
 - Door locks are powered from and remotely accessed through the PDU
- Mounting:
 - Vertical PDUs: 2 preinstalled tool-less mounting buttons; adjustable positions; Top or bottom power cord entry orientation
 - Horizontal PDUs: Include rack-mount brackets for 19"EIA (482.6 mm) racks
- Dimensions:
 - For specific dimensions, download the individual product cut sheets by searching the base part number (ex: Ex-xxx) on chatsworth.com

Certifications:

- UL/cUL/IEC62368, CE (EU), FCC Part 15, Class A, EN 55022, RoHS Compliant



The Power Selector enables you to select the best power product for your application by narrowing down options based on your requirements. After you're done comparing, you can email or print the results. Visit selectapdu.com to access the Power Selector.

| Monitored eConnect PDU, Vertical - North America | | | | | | | | | |
|---|----------------|-------------------|----------------|-----------------------------------|-------------------------------|----------------------------|--------------------------------|--------------------|--|
| Part Number | | | Input Amperage | Input Plug | Outlets | kW Capacity (UL) | Cabinet Capability | | |
| Black* | Glacier White* | Redundancy Pack** | | | | | | | |
| 120 Volt, Single-Phase Input | | | | | | | | | |
| EA-3001-C | EA-3001-E | EA-3001-CE | 20A | C20 Inlet to L5-20 | (24) 5-20 | 1.9 kW | 42U & higher | | |
| EA-3002-C | EA-3002-E | EA-3002-CE | 30A | L5-30 | (24) 5-20 | 2.9 kW | 42U & higher | | |
| 208 Volt, Single-Phase Input | | | | | | | | | |
| EA-3003-C | EA-3003-E | EA-3003-CE | 20A | C20 Inlet to L6-20 | (24) C13 | 3.3 kW | 42U & higher | | |
| EA-3004-C | EA-3004-E | EA-3004-CE | 30A | L6-30 | (24) C13 | 5 kW | 42U & higher | | |
| EA-3015-C | EA-3015-E | EA-3015-CE | 30A | L6-30 | (36) C13 + (6) C19 | 5 kW | 42U & higher | | |
| 120/208 Volt, Single-Phase Input | | | | | | | | | |
| EA-3087-C | EA-3087-E | EA-3087-CE | 30A | L14-30 | (30) C13 + (6) C19 + (6) 5-20 | 5 kW | 42U & higher | | |
| 120/208 Volt, Three-Phase Input | | | | | | | | | |
| EA-3013-C | EA-3013-E | EA-3013-CE | 20A | L21-20 | (30) C13 + (6) C19 + (6) 5-20 | 5.7 kW | 42U & higher | | |
| EA-3017-C | EA-3017-E | EA-3017-CE | 20A | L21-20 | (36) C13 + (6) C19 | 5.7 kW | 42U & higher | | |
| EA-3014-C | EA-3014-E | EA-3014-CE | 30A | L21-30 | (30) C13 + (6) C19 + (6) 5-20 | 8.6 kW | 42U & higher | | |
| EA-3018-C | EA-3018-E | EA-3018-CE | 30A | L21-30 | (36) C13 + (6) C19 | 8.6 kW | 42U & higher | | |
| 208 Volt, Three-Phase Input | | | | | | | | | |
| EA-3016-C | EA-3016-E | EA-3016-CE | 30A | L15-30 | (36) C13 + (6) C19 | 8.6 kW | 42U & higher | | |
| EA-3007-C | EA-3007-E | EA-3007-CE | 50A | CS8365 | (30) C13 + (12) C19 | 14.4 kW | 42U & higher | | |
| EA-3019-C | EA-3019-E | EA-3019-CE | 50A | CS8365 | (36) C13 + (6) C19 | 14.4 kW | 42U & higher | | |
| EA-3125-C | EA-3125-E | EA-3125-CE | 50A | CS8365 | (54) C13 | 14.4 kW | 45U & higher | | |
| EA-3126-C | EA-3126-E | EA-3126-CE | 50A | CS8365 | (54) C13 | 17.2 kW | 45U & higher | | |
| EA-3008-C | EA-3008-E | EA-3008-CE | 60A | IEC 60309 60A 3P+E | (30) C13 + (12) C19 | 17.2 kW | 42U & higher | | |
| EA-3020-C | EA-3020-E | EA-3020-CE | 60A | IEC 60309 60A 3P+E | (36) C13 + (6) C19 | 17.2 kW | 42U & higher | | |
| EA-3033-C | EA-3033-E | EA-3033-CE | 60A | IEC 60309 60A 3P+E | (12) C13 + (18) C19 | 17.2 kW | 42U & higher | | |
| 240/415 Volt, Three-Phase Input | | | | | | | | | |
| EA-3021-C | EA-3021-E | EA-3021-CE | 30A | L22-30 | (36) C13 + (6) C19 | 17.2 kW | 42U & higher | | |
| EA-3127-C | EA-3127-E | EA-3127-CE | 30A | L22-30 | (54) C13 | 17.2 kW | 45U & higher | | |
| Monitored eConnect PDU, Vertical - Worldwide | | | | | | | | | |
| Part Number | | | Input Amperage | Input Plug | Outlets | kW Capacity Worldwide (CE) | kW Capacity North America (UL) | Cabinet Capability | |
| Black* | Glacier White* | Redundancy Pack** | | | | | | | |
| 220 - 240 Volt, Single-Phase Input | | | | | | | | | |
| EA-3005-C | EA-3005-E | EA-3005-CE | 16A | C20 Inlet to IEC 60309 16A 1P+N+E | (24) C13 | 3.8kW | 3.8kW | 42U & higher | |
| EA-3006-C | EA-3006-E | EA-3006-CE | 32A | C20 Inlet to IEC 60309 32A 1P+N+E | (24) C13 | 7.7 kW | 6.1 kW | 42U & higher | |
| EA-3022-C | EA-3022-E | EA-3022-CE | 32A | C20 Inlet to IEC 60309 32A 1P+N+E | (36) C13 + (6) C19 | 7.7 kW | 6.1 kW | 42U & higher | |
| 220-240/380-415 Volt, Three-Phase Input | | | | | | | | | |
| EA-3023-C | EA-3023-E | EA-3023-CE | 16/20A | IEC 60309 16/20A 3P+N+E | (36) C13 + (6) C19 | 11.5 kW | 11.5 kW | 42U & higher | |
| EA-3009-C | EA-3009-E | EA-3009-CE | 32A | IEC 60309 32A 3P+N+E | (30) C13 + (12) C19 | 23 kW | 18.4 kW | 42U & higher | |
| EA-3024-C | EA-3024-E | EA-3024-CE | 32A | IEC 60309 32A 3P+N+E | (36) C13 + (6) C19 | 23 kW | 18.4 kW | 42U & higher | |
| EA-3128-C | EA-3128-E | EA-3128-CE | 32A | IEC 60309 20A 3P+N+E | (54) C13 | 23 kW | 18.4 kW | 45U & higher | |

Notes: * Shipping weight for each unit is 27 lb (12 kg). **Redundancy Pack includes 2 PDUs in Black and Glacier White for easy identification of the primary and secondary unit; shipping weight is 54 lb (24 kg).

| Monitored eConnect PDU, Horizontal - North America | | | | | | | |
|--|----------------|-------------------|----------------|--------------------|-------------------|------------------|------------------------|
| Part Number | | | Input Amperage | Input Plug | Outlets | kW Capacity (UL) | Form Factor (U) Height |
| Black* | Glacier White* | Redundancy Pack** | | | | | |
| 120 Volt, Single-Phase Input | | | | | | | |
| EA-3243-C | EA-3243-E | EA-3243-CE | 20A | C20 Inlet to L5-20 | (12) 5-20 | 1.9 kW | 1U |
| EA-3244-C | EA-3244-E | EA-3244-CE | 30A | NEMA L5-30P | (12) 5-20 | 2.9 kW | 1U |
| 208 Volt, Single-Phase Input | | | | | | | |
| EA-3245-C | EA-3245-E | EA-3245-CE | 20A | C20 Inlet to L6-20 | (12) C13 | 3.3 kW | 1U |
| EA-3270-C | EA-3270-E | EA-3270-CE | 20A | C20 Inlet to L6-20 | (8) C13 + (4) C19 | 3.3 kW | 1U |
| EA-3246-C | EA-3246-E | EA-3246-CE | 30A | NEMA L6-30P | (12) C13 | 5 kW | 1U |
| EA-3253-C | EA-3253-E | EA-3253-CE | 30A | NEMA L6-30P | (9) C19 | 5 kW | 1U |
| EA-3271-C | EA-3271-E | EA-3271-CE | 30A | NEMA L6-30P | (8) C13 + (4) C19 | 5 kW | 1U |
| 120/208 Volt, Three-Phase Input | | | | | | | |
| EA-3248-C | EA-3248-E | EA-3248-CE | 20A | NEMA L21-20P | (12) C13 | 5.7 kW | 1U |
| EA-3255-C | EA-3255-E | EA-3255-CE | 20A | NEMA L21-20P | (9) C19 | 5.7 kW | 1U |
| EA-3273-C | EA-3273-E | EA-3273-CE | 20A | NEMA L21-20P | (8) C13 + (4) C19 | 5.7 kW | 1U |
| EA-3249-C | EA-3249-E | EA-3249-CE | 30A | NEMA L21-30P | (12) C13 | 8.6 kW | 1U |
| EA-3256-C | EA-3256-E | EA-3256-CE | 30A | NEMA L21-30P | (9) C19 | 8.6 kW | 1U |
| EA-3274-C | EA-3274-E | EA-3274-CE | 30A | NEMA L21-30P | (8) C13 + (4) C19 | 8.6 kW | 1U |
| 208 Volt, Three-Phase Input | | | | | | | |
| EA-3247-C | EA-3247-E | EA-3247-CE | 30A | NEMA L15-30P | (12) C13 | 8.6 kW | 1U |
| EA-3254-C | EA-3254-E | EA-3254-CE | 30A | NEMA L15-30P | (9) C19 | 8.6 kW | 1U |
| EA-3272-C | EA-3272-E | EA-3272-CE | 30A | NEMA L15-30P | (8) C13 + (4) C19 | 8.6 kW | 1U |

| Monitored eConnect PDU, Horizontal - Worldwide | | | | | | | | |
|--|----------------|-------------------|----------------|-----------------------------------|-------------------|------------------|--------------------------------|------------------------|
| Part Number | | | Input Amperage | Input Plug | Outlets | kW Capacity (UL) | kW Capacity North America (UL) | Form Factor (U) Height |
| Black* | Glacier White* | Redundancy Pack** | | | | | | |
| 220 - 240 Volt, Single-Phase Input | | | | | | | | |
| EA-3250-C | EA-3250-E | EA-3250-CE | 16A | C20 Inlet to IEC 60309 16A 1P+N+E | (12) C13 | 3.8 kW | 3.8 kW | 1U |
| EA-3275-C | EA-3275-E | EA-3275-CE | 16A | C20 Inlet to IEC 60309 16A 1P+N+E | (8) C13 + (4) C19 | 3.8 kW | 3.8 kW | 1U |
| EA-3252-C | EA-3252-E | EA-3252-CE | 32A | IEC 60309 32A 1P+N+E | (12) C13 | 7.7 kW | 6.1 kW | 1U |
| EA-3257-C | EA-3257-E | EA-3257-CE | 32A | IEC 60309 32A 1P+N+E | (9) C19 | 7.7 kW | 6.1 kW | 1U |
| EA-3277-C | EA-3277-E | EA-3277-CE | 32A | IEC 60309 32A 1P+N+E | (8) C13 + (4) C19 | 7.7 kW | 6.1 kW | 1U |
| 220 - 240/380-415 Volt, Three-Phase Input | | | | | | | | |
| EA-3251-C | EA-3251-E | EA-3251-CE | 16/20A | IEC 60309 16/20A 3P+N+E | (12) C13 | 11.5 kW | 11.5 kW | 1U |
| EA-3258-C | EA-3258-E | EA-3258-CE | 16/20A | IEC 60309 16/20A 3P+N+E | (9) C19 | 11.5 kW | 11.5 kW | 1U |
| EA-3276-C | EA-3276-E | EA-3276-CE | 16/20A | IEC 60309 16/20A 3P+N+E | (8) C13 + (4) C19 | 11.5 kW | 11.5 kW | 1U |

Notes: * Shipping weight for each unit is 18 lb (8.2 kg) **Redundancy Pack includes 2 PDUs in Black and Glacier White for easy identification of the primary and secondary unit; shipping weight is 35 lb (15.9 kg)

| Monitored eConnect PDU, Horizontal - North America | | | | | | | | |
|--|----------------|-------------------|----------------|--------------------|-------------------------------|------------------|------------------------|----|
| Part Number | | | Input Amperage | Input Plug | Outlets | kW Capacity (UL) | Form Factor (U) Height | |
| Black* | Glacier White* | Redundancy Pack** | | | | | | |
| 120 Volt, Single-Phase Input | | | | | | | | |
| EA-3401-C | EA-3401-E | EA-3401-CE | 20A | C20 Inlet to L5-20 | (24) 5-20 | 1.9 kW | | 2U |
| EA-3402-C | EA-3402-E | EA-3402-CE | 30A | NEMA L5-30P | (24) 5-20 | 2.9 kW | | 2U |
| 208 Volt, Single-Phase Input | | | | | | | | |
| EA-3403-C | EA-3403-E | EA-3403-CE | 20A | C20 Inlet to L6-20 | (24) C13 | 3.3 kW | | 2U |
| EA-3459-C | EA-3459-E | EA-3459-CE | 20A | C20 Inlet to L6-20 | (18) C13 + (6) C19 | 3.3 kW | | 2U |
| EA-3404-C | EA-3404-E | EA-3404-CE | 30A | NEMA L6-30P | (24) C13 | 5 kW | | 2U |
| EA-3461-C | EA-3461-E | EA-3461-CE | 30A | NEMA L6-30P | (18) C13 + (6) C19 | 5 kW | | 2U |
| EA-3478-C | EA-3478-E | EA-3478-CE | 30A | NEMA L6-30P | (6) C13 + (12) C19 | 5 kW | | 2U |
| 120/208 Volt, Single-Phase Input | | | | | | | | |
| EA-3469-C | EA-3469-E | EA-3469-CE | 30A | NEMA L14-30P | (12) C13 + (6) C19 + (4) 5-20 | 5 kW | | 2U |
| 120/208 Volt, Three-Phase Input | | | | | | | | |
| EA-3439-C | EA-3439-E | EA-3439-CE | 20A | NEMA L21-20P | (24) C13 | 5.7 kW | | 2U |
| EA-3463-C | EA-3463-E | EA-3463-CE | 20A | NEMA L21-20P | (18) C13 + (6) C19 | 5.7 kW | | 2U |
| EA-3480-C | EA-3480-E | EA-3480-CE | 20A | NEMA L21-20P | (6) C13 + (12) C19 | 5.7 kW | | 2U |
| EA-3467-C | EA-3467-E | EA-3467-CE | 20A | NEMA L21-20P | (12) C13 + (6) C19 + (4) 5-20 | 5.7 kW | | 2U |
| EA-3440-C | EA-3440-E | EA-3440-CE | 30A | NEMA L21-30P | (24) C13 | 8.6 kW | | 2U |
| EA-3464-C | EA-3464-E | EA-3464-CE | 30A | NEMA L21-30P | (18) C13 + (6) C19 | 8.6 kW | | 2U |
| EA-3482-C | EA-3482-E | EA-3482-CE | 30A | NEMA L21-30P | (6) C13 + (12) C19 | 8.6 kW | | 2U |
| EA-3468-C | EA-3468-E | EA-3468-CE | 30A | NEMA L21-30P | (12) C13 + (6) C19 + (4) 5-20 | 8.6 kW | | 2U |
| 208 Volt, Three-Phase Input | | | | | | | | |
| EA-3441-C | EA-3441-E | EA-3441-CE | 30A | NEMA L15-30P | (24) C13 | 8.6 kW | | 2U |
| EA-3465-C | EA-3465-E | EA-3465-CE | 30A | NEMA L15-30P | (18) C13 + (6) C19 | 8.6 kW | | 2U |
| EA-3483-C | EA-3483-E | EA-3483-CE | 30A | NEMA L15-30P | (6) C13 + (12) C19 | 8.6 kW | | 2U |
| EA-3484-C | EA-3484-E | EA-3484-CE | 50A | CS8365 | (6) C13 + (12) C19 | 14.4 kW | | 2U |
| EA-3485-C | EA-3485-E | EA-3485-CE | 60A | IEC 60309 60A 3P+E | (6) C13 + (12) C19 | 17.2 kW | | 2U |

| Monitored eConnect PDU, Horizontal - Worldwide | | | | | | | | |
|--|----------------|-------------------|----------------|-----------------------------------|--------------------|------------------|--------------------------------|------------------------|
| Part Number | | | Input Amperage | Input Plug | Outlets | kW Capacity (UL) | kW Capacity North America (UL) | Form Factor (U) Height |
| Black* | Glacier White* | Redundancy Pack** | | | | | | |
| 220 - 240 Volt, Single-Phase Input | | | | | | | | |
| EA-3405-C | EA-3405-E | EA-3405-CE | 16A | C20 Inlet to IEC 60309 16A 1P+N+E | (24) C13 | 3.8 kW | 3.8 kW | 2U |
| EA-3460-C | EA-3460-E | EA-3460-CE | 16A | C20 Inlet to IEC 60309 16A 1P+N+E | (18) C13 + (6) C19 | 3.8 kW | 3.8 kW | 2U |
| EA-3406-C | EA-3406-E | EA-3406-CE | 32A | IEC 60309 32A 1P+N+E | (24) C13 | 7.7 kW | 6.1 kW | 2U |
| EA-3462-C | EA-3462-E | EA-3462-CE | 32A | IEC 60309 32A 1P+N+E | (18) C13 + (6) C19 | 7.7 kW | 6.1 kW | 2U |
| EA-3479-C | EA-3479-E | EA-3479-CE | 32A | IEC 60309 32A 1P+N+E | (6) C13 + (12) C19 | 7.7 kW | 6.1 kW | 2U |
| 220 - 240/380-415 Volt, Three-Phase Input | | | | | | | | |
| EA-3442-C | EA-3442-E | EA-3442-CE | 16/20A | IEC 60309 16/20A 3P+N+E | (24) C13 | 11.5 kW | 11.5 kW | 2U |
| EA-3466-C | EA-3466-E | EA-3466-CE | 16/20A | IEC 60309 16/20A 3P+N+E | (18) C13 + (6) C19 | 11.5 kW | 11.5 kW | 2U |
| EA-3481-C | EA-3481-E | EA-3481-CE | 16/20A | IEC 60309 16/20A 3P+N+E | (6) C13 + (12) C19 | 11.5 kW | 11.5 kW | 2U |
| EA-3486-C | EA-3486-E | EA-3486-CE | 32A | IEC 60309 32A 3P+N+E | (6) C13 + (12) C19 | 23 kW | 18.4 kW | 2U |

Notes: * Shipping weight for each unit is 23 lb (10.4 kg); **Redundancy Pack includes 2 PDUs in Black and Glacier White for easy identification of the primary and secondary unit; shipping weight is 45 lb (20.4 kg)



Monitored Pro eConnect PDUs provide remote power monitoring down to the outlet level, making it possible to obtain power consumption for each piece of equipment.

Reduced Networking Costs and Complexity

Secure Array® allows the use of a single IP address for up to 48 connected PDUs (32 when electronic locks are integrated). Second IP address for the entire array provides failover capability

Simplified Load Balancing

Phase-balance outlets on three-phase models ensure equal loading across all phases; allows use of shorter equipment power cords for better cable and airflow management

No Accidental Disconnections

Patented, low-profile locking outlets prevent accidental disconnections without requiring special cords

Electronic Lock Integration

Patented technology seamlessly integrates PDU, environmental sensors and electronic locks into a single hardware and software solution

Gigabit Ethernet

Ensures compatibility with enterprise routers and switches

Cabinet Preinstallation

Complete ecosystem ships ready for IT equipment integration. Saves deployment time and reduces packaging waste.

Monitored Pro eConnect PDU

Additional Features:

- Individual outlet monitoring; outlet grouping
- Field-replaceable controller module for easy serviceability and upgradeability while maintaining power to critical loads; SD-card transfers PDU configuration
- Onboard GUI, RESTful API, SNMP v1/v2/v3, Command Line Interface (CLI), and native Power IQ® DCIM software integration allows users to easily manage PDU
- Zero Touch Provisioning (ZTP) automates configuration and provisioning of large deployments of PDUs.
- HTTPs support, RADIUS and LDAP integration for enhanced authentication and security
- Customization capabilities: outlet configurations, color options, power cord length, input connection types and more
- Made in the United States, TAA-compliant

Specifications:

- Single-input, vertical and horizontal rack-mount PDU
- Circuit Protection:
 - UL 489 listed, single- or two-pole, hydraulic-magnetic breakers available on single- and three-phase models with 30A and above input
 - 10kAIC breakers on 220-240/380-415 VAC models; 5kAIC for all other models
 - Low-profile design prevents accidental discharge
- Metering:
 - Input line currents
 - Voltage, current, power, energy and power factor at branch circuits and individual outlets
 - +/- 1% billing-grade
 - Ability to name outlets to identify attached equipment
 - Outlet grouping for power charge back reports
- Networking:
 - 10/100/1000MB Ethernet Port
 - Secure Array IP Consolidation for up to 48 PDUs with no integrated electronic locks or 32 PDUs with integrated electronic locks
 - Secure Array IP Consolidation supports alternate/failover network connection through a second PDU
- Console Access:
 - Through serial console port connection and Command Line Interface (CLI)
- Controller:
 - Field-replaceable module; SD-card transfers PDU configuration
- Firmware:
 - Flash upgradeable through USB port, Web interface, CLI, API or Power IQ
- Electronic Lock Integration:
 - Front and rear cabinet door locks (ordered separately) connected to AUX ports on the PDU
 - Door locks are powered from and remotely accessed through the PDU
- Mounting:
 - Vertical PDUs: 2 preinstalled tool-less mounting buttons; adjustable positions; Top or bottom power cord entry orientation
- Dimensions:
 - For specific dimensions, download the individual product cut sheets by searching the base part number (ex: Ex-xxxx) on chatsworth.com

Certifications:

- UL/cUL/IEC62368, CE (EU), FCC Part 15, Class A, EN 55022, RoHS Compliant

| Monitored Pro eConnect PDU, Vertical - North America | | | | | | | |
|--|----------------|-------------------|----------------|--------------------|---|------------------|------------------|
| Part Number | | | Input Amperage | Input Plug | Outlets | kW Capacity (UL) | Cabinet Capacity |
| Black* | Glacier White* | Redundancy Pack** | | | | | |
| 120 Volt, Single-Phase Input | | | | | | | |
| EA-4001-C | EA-4001-E | EA-4001-CE | 20A | C20 Inlet to L5-20 | (24) 5-20 | 1.9 kW | 42U & higher |
| EA-4002-C | EA-4002-E | EA-4002-CE | 30A | L5-30 | (24) 5-20 | 2.9 kW | 42U & higher |
| 208 Volt, Single-Phase Input | | | | | | | |
| EA-4069-C | EA-4069-E | EA-4069-CE | 20A | C20 Inlet to L6-20 | (18) C13 + (6) C19 | 3.3 kW | 42U & higher |
| EA-4070-C | EA-4070-E | EA-4070-CE | 20A | C20 Inlet to L6-20 | (24) C13 | 3.3 kW | 42U & higher |
| EA-4004-C | EA-4004-E | EA-4004-CE | 30A | L6-30 | (24) C13 | 5 kW | 42U & higher |
| EA-4012-C | EA-4012-E | EA-4012-CE | 30A | L6-30 | (18) C13 + (6) C19 | 5 kW | 42U & higher |
| 120 - 208 Volt, Three-Phase Input | | | | | | | |
| EA-4006-C | EA-4006-E | EA-4006-CE | 20A | L21-20 | (24) C13 | 5.7 kW | 42U & higher |
| EA-4014-C | EA-4014-E | EA-4014-CE | 20A | L21-20 | (18) C13 + (6) C19 | 5.7 kW | 42U & higher |
| EA-4025-C | EA-4025-E | EA-4025-CE | 20A | L21-20 | (18) C13 + (6) C19 Outlets + (3) 5-20 Convenience Outlets**** | 5.7 kW | 42U & higher |
| EA-4007-C | EA-4007-E | EA-4007-CE | 30A | L21-30 | (24) C13 | 8.6 kW | 42U & higher |
| EA-4015-C | EA-4015-E | EA-4015-CE | 30A | L21-30 | (18) C13 + (6) C19 | 8.6 kW | 42U & higher |
| EA-4026-C | EA-4026-E | EA-4026-CE | 30A | L21-30 | (18) C13 + (6) C19 Outlets + (3) 5-20 Convenience Outlets**** | 8.6 kW | 42U & higher |
| EA-4035-C | EA-4035-E | EA-4035-CE | 30A | L21-30 | (36) C13 | 8.6 kW | 42U & higher |
| 208 Volt, Three-Phase Input | | | | | | | |
| EA-4005-C | EA-4005-E | EA-4005-CE | 30A | L15-30 | (24) C13 | 8.6 kW | 42U & higher |
| EA-4013-C | EA-4013-E | EA-4013-CE | 30A | L15-30 | (18) C13 + (6) C19 | 8.6 kW | 42U & higher |
| EA-4034-C | EA-4034-E | EA-4034-CE | 30A | L15-30 | (36) C13 | 8.6 kW | 42U & higher |
| EA-4016-C | EA-4016-E | EA-4016-CE | 50A | CS8365 | (18) C13 + (6) C19 | 14.4 kW | 42U & higher |
| EA-4027-C | EA-4027-E | EA-4027-CE | 50A | CS8365 | (12) C13 + (12) C19 | 14.4 kW | 42U & higher |
| EA-4136-C | EA-4136-E | EA-4136-CE | 50A | CS8365 | (36) C13 | 14.4kW | 45U & higher |
| EA-4144-C | EA-4144-E | EA-4144-CE | 50A | CS8365 | (24) C13 + (12) C19 | 14.4 kW | 45U & higher |
| EA-4017-C | EA-4017-E | EA-4017-CE | 60A | IEC 60309 60A 3P+E | (18) C13 + (6) C19 | 17.2 kW | 42U & higher |
| EA-4028-C | EA-4028-E | EA-4028-CE | 60A | IEC 60309 60A 3P+E | (12) C13 + (12) C19 | 17.2 kW | 42U & higher |
| EA-4137-C | EA-4137-E | EA-4137-CE | 60A | IEC 60309 60A 3P+E | (36) C13 | 17.2 kW | 45U & higher |
| EA-4145-C | EA-4145-E | EA-4145-CE | 60A | IEC 60309 60A 3P+E | (24) C13 + (12) C19 | 17.2 kW | 45U & higher |
| 240/415 Volt, Three-Phase Input | | | | | | | |
| EA-4018-C | EA-4018-E | EA-4018-CE | 30A | L22-30 | (18) C13 + (6) C19 | 17.2 kW | 42U & higher |
| EA-4029-C | EA-4029-E | EA-4029-CE | 30A | L22-30 | (12) C13 + (12) C19 | 17.2 kW | 42U & higher |
| EA-4038-C | EA-4038-E | EA-4038-CE | 30A | L22-30 | (36) C13 | 17.2 kW | 42U & higher |
| EA-4046-C | EA-4046-E | EA-4046-CE | 30A | L22-30 | (24) C13 + (12) C19 | 17.2 kW | 42U & higher |

Notes: *Shipping weight for each unit is 27 lb (12 kg).

**Redundancy Pack includes 2 PDUs in Black and Glacier White for easy identification of the primary and secondary unit; shipping weight is 54 lb (24 kg).

***Convenience outlets do not provide monitoring or switching capabilities.

| Monitored Pro eConnect PDU, Vertical - Worldwide | | | | | | | | |
|--|----------------|-------------------|----------------|-----------------------------------|---------------------|----------------------------|--------------------------------|--------------------|
| Part Number | | | Input Amperage | Input Plug | Outlets | kW Capacity Worldwide (CE) | kW Capacity North America (UL) | Cabinet Capability |
| Black* | Glacier White* | Redundancy Pack** | | | | | | |
| 220 - 240 Volt, Single-Phase Input | | | | | | | | |
| EA-4008-C | EA-4008-E | EA-4008-CE | 16A | C20 Inlet to IEC 60309 16A 1P+N+E | (24) C13 | 3.8kW | 3.8kW | 42U & higher |
| EA-4019-C | EA-4019-E | EA-4019-CE | 16A | C20 Inlet to IEC 60309 16A 1P+N+E | (18) C13 + (6) C19 | 3.8kW | 3.8kW | 42U & higher |
| EA-4009-C | EA-4009-E | EA-4009-CE | 32A | IEC 60309 32A 1P+N+E | (24) C13 | 7.7 kW | 6.1kW | 42U & higher |
| EA-4020-C | EA-4020-E | EA-4020-CE | 32A | IEC 60309 32A 1P+N+E | (18) C13 + (6) C19 | 7.7 kW | 6.1kW | 42U & higher |
| 220-240/380-415 Volt, Three-Phase Input | | | | | | | | |
| EA-4010-C | EA-4010-E | EA-4010-CE | 16/20A | IEC 60309 16/20A 3P+N+E | (24) C13 | 11.5kW | 11.5kW | 42U & higher |
| EA-4021-C | EA-4021-E | EA-4021-CE | 16/20A | IEC 60309 16/20A 3P+N+E | (18) C13 + (6) C19 | 11.5kW | 11.5kW | 42U & higher |
| EA-4030-C | EA-4030-E | EA-4030-CE | 16/20A | IEC 60309 16/20A 3P+N+E | (12) C13 + (12) C19 | 11.5kW | 11.5kW | 42U & higher |
| EA-4039-C | EA-4039-E | EA-4039-CE | 16/20A | IEC 60309 16/20A 3P+N+E | (36) C13 | 11.5kW | 11.5kW | 42U & higher |
| EA-4047-C | EA-4047-E | EA-4047-CE | 16/20A | IEC 60309 16/20A 3P+N+E | (24) C13 + (12) C19 | 11.5kW | 11.5kW | 42U & higher |
| EA-4022-C | EA-4022-E | EA-4022-CE | 32A | IEC 60309 32A 3P+N+E | (18) C13 + (6) C19 | 23 kW | 18.4kW | 42U & higher |
| EA-4031-C | EA-4031-E | EA-4031-CE | 32A | IEC 60309 32A 3P+N+E | (12) C13 + (12) C19 | 23 kW | 18.4kW | 42U & higher |
| EA-4040-C | EA-4040-E | EA-4040-CE | 32A | IEC 60309 32A 3P+N+E | (36) C13 | 23 kW | 18.4kW | 42U & higher |
| EA-4048-C | EA-4048-E | EA-4048-CE | 32A | IEC 60309 32A 3P+N+E | (24) C13 + (12) C19 | 23 kW | 18.4kW | 42U & higher |

Notes: * Shipping weight for each unit is 27 lb (12 kg).

**Redundancy Pack includes 2 PDUs (one in Black and one in Glacier White) for easy identification of the primary and secondary unit; shipping weight is 54 lb (24 kg).



The Power Selector enables you to select the best power product for your application by narrowing down options based on your requirements. After you're done comparing, you can email or print the results. Visit selectapdu.com to access the Power Selector.



Switched eConnect PDUs provide remote monitoring of power at the rack level and individual outlet control, making it possible to remotely turn power on or off at each outlet.

Reduced Networking Costs and Complexity

Secure Array® allows the use of a single IP address for up to 48 connected PDUs (32 when electronic locks are integrated). Second IP address for the entire array provides failover capability

Simplified Load Balancing

Phase-balance outlets on three-phase models ensure equal loading across all phases; allows use of shorter equipment power cords for better cable and airflow management

No Accidental Disconnections

Patented, low-profile locking outlets prevent accidental disconnections without requiring special cords

Electronic Lock Integration

Patented technology seamlessly integrates PDU, environmental sensors and electronic locks into a single hardware and software solution

Gigabit Ethernet

Ensures compatibility with enterprise routers and switches

Cabinet Preinstallation

Complete ecosystem ships ready for IT equipment integration. Saves deployment time and reduces packaging waste.

Switched eConnect PDU

Additional Features:

- PDU monitoring and individual outlet switching; outlet grouping
- Field-replaceable controller module for easy serviceability and upgradeability while maintaining power to critical loads; SD-card transfers PDU configuration
- Bistable latching relays for reduced energy consumption and increased service reliability; maintains last state of power outlet if power is interrupted
- Input and branch circuit monitoring with billing-grade +/-1% accuracy
- Onboard GUI, RESTful API, SNMP v1/v2/v3, Command Line Interface (CLI), and native Power IQ® DCIM software integration allows users to easily manage PDUs
- Zero Touch Provisioning (ZTP) automates configuration and provisioning of large deployments of PDUs.
- HTTPs support, RADIUS and LDAP integration for enhanced authentication and security
- Customization capabilities: outlet configurations, color options, power cord length, input connection types and more
- Made in the United States, TAA-compliant

Specifications:

- Single-input, vertical rack-mount PDUs
 - Circuit Protection:
 - UL 489 listed, single- or two-pole, hydraulic-magnetic breakers available on single- and three-phase models with 30A and above input
 - 10kAIC breakers on 220-240/380-415 VAC models; 5kAIC for all other models
 - Low-profile design prevents accidental discharge
 - Metering:
 - Input line currents
 - Voltage, current, power, energy and power factor at branch circuits
 - +/- 1% billing-grade
 - Ability to name outlets to identify attached equipment
 - Outlet grouping for power charge back reports
 - Switching:
 - Ability to turn on/off and cycle power to individual or group of outlets using bistable latching relays
 - Ability to name individual outlets to identify attached equipment
 - Status indicator LED light for individual outlets
 - Console Access:
 - Through serial console port connection and Command Line Interface (CLI)
 - Controller:
 - Field-replaceable module; SD-card transfers PDU configuration
 - Firmware:
 - Flash upgradeable through USB port, Web interface, CLI, API or Power IQ
 - Electronic Lock Integration:
 - Front and rear cabinet door locks (ordered separately) connected to AUX ports on the PDU
 - Door locks are powered from and remotely accessed through the PDU
 - Mounting:
 - Vertical PDUs: 2 preinstalled tool-less mounting buttons; adjustable positions
 - Top or bottom power cord entry orientation
 - Dimensions:
 - For specific dimensions, download the individual product cut sheets by searching the base part number (ex: Ex-xxxx) on chatsworth.com
- ### Certifications:
- UL/cUL/IEC62368, CE (EU), FCC Part 15, Class A, EN 55022, RoHS Compliant

| Switched eConnect PDU, Vertical - North America | | | | | | | |
|---|----------------|-------------------|----------------|--------------------|--|------------------|--------------------|
| Part Number | | | Input Amperage | Input Plug | Outlets | kW Capacity (UL) | Cabinet Capability |
| Black* | Glacier White* | Redundancy Pack** | | | | | |
| 120 Volt, Single-Phase Input | | | | | | | |
| EA-5001-C | EA-5001-E | EA-5001-CE | 20A | C20 Inlet to L5-20 | (24) 5-20 | 1.9 kW | 42U & higher |
| EA-5002-C | EA-5002-E | EA-5002-CE | 30A | L5-30 | (24) 5-20 | 2.9 kW | 42U & higher |
| 208 Volt, Single-Phase Input | | | | | | | |
| EA-5069-C | EA-5069-E | EA-5069-CE | 20A | C20 Inlet to L6-20 | (18) C13 + (6) C19 | 3.3 kW | 42U & higher |
| EA-5070-C | EA-5070-E | EA-5070-CE | 20A | C20 Inlet to L6-20 | (24) C13 | 3.3 kW | 42U & higher |
| EA-5004-C | EA-5004-E | EA-5004-CE | 30A | L6-30 | (24) C13 | 5 kW | 42U & higher |
| EA-5012-C | EA-5012-E | EA-5012-CE | 30A | L6-30 | (18) C13 + (6) C19 | 5 kW | 42U & higher |
| 120/208 Volt, Three-Phase Input | | | | | | | |
| EA-5006-C | EA-5006-E | EA-5006-CE | 20A | L21-20 | (24) C13 | 5.7 kW | 42U & higher |
| EA-5014-C | EA-5014-E | EA-5014-CE | 20A | L21-20 | (18) C13 + (6) C19 | 5.7 kW | 42U & higher |
| EA-5025-C | EA-5025-E | EA-5025-CE | 20A | L21-20 | (18) C13 + (6) C19 Outlets + (3) 5-20 Convenience Outlets*** | 5.7 kW | 42U & higher |
| EA-5007-C | EA-5007-E | EA-5007-CE | 30A | L21-30 | (24) C13 | 8.6 kW | 42U & higher |
| EA-5015-C | EA-5015-E | EA-5015-CE | 30A | L21-30 | (18) C13 + (6) C19 | 8.6 kW | 42U & higher |
| EA-5026-C | EA-5026-E | EA-5026-CE | 30A | L21-30 | (18) C13 + (6) C19 Outlets + (3) 5-20 Convenience Outlets*** | 8.6 kW | 42U & higher |
| EA-5035-C | EA-5035-E | EA-5035-CE | 30A | L21-30 | (36) C13 | 8.6 kW | 42U & higher |
| 208 Volt, Three-Phase Input | | | | | | | |
| EA-5005-C | EA-5005-E | EA-5005-CE | 30A | L15-30 | (24) C13 | 8.6 kW | 42U & higher |
| EA-5013-C | EA-5013-E | EA-5013-CE | 30A | L15-30 | (18) C13 + (6) C19 | 8.6 kW | 42U & higher |
| EA-5034-C | EA-5034-E | EA-5034-CE | 30A | L15-30 | (36) C13 | 8.6 kW | 42U & higher |
| EA-5016-C | EA-5016-E | EA-5016-CE | 50A | CS8365 | (18) C13 + (6) C19 | 14.4 kW | 42U & higher |
| EA-5027-C | EA-5027-E | EA-5027-CE | 50A | CS8365 | (12) C13 + (12) C19 | 14.4 kW | 42U & higher |
| EA-5136-C | EA-5136-E | EA-5136-CE | 50A | CS8365 | (36) C13 | 14.4 kW | 45U & higher |
| EA-5144-C | EA-5144-E | EA-5144-CE | 50A | CS8365 | (24) C13 + (12) C19 | 14.4 kW | 45U & higher |
| EA-5017-C | EA-5017-E | EA-5017-CE | 60A | IEC 60309 60A 3P+E | (18) C13 + (6) C19 | 17.2 kW | 42U & higher |
| EA-5028-C | EA-5028-E | EA-5028-CE | 60A | IEC 60309 60A 3P+E | (12) C13 + (12) C19 | 17.2 kW | 42U & higher |
| EA-5137-C | EA-5137-E | EA-5137-CE | 60A | IEC 60309 60A 3P+E | (36) C13 | 17.2 kW | 45U & higher |
| EA-5145-C | EA-5145-E | EA-5145-CE | 60A | IEC 60309 60A 3P+E | (24) C13 + (12) C19 | 17.2 kW | 45U & higher |
| 240/415 Volt, Three-Phase Input | | | | | | | |
| EA-5018-C | EA-5018-E | EA-5018-CE | 30A | L22-30 | (18) C13 + (6) C19 | 17.2 kW | 42U & higher |
| EA-5029-C | EA-5029-E | EA-5029-CE | 30A | L22-30 | (12) C13 + (12) C19 | 17.2 kW | 42U & higher |
| EA-5038-C | EA-5038-E | EA-5038-CE | 30A | L22-30 | (36) C13 | 17.2 kW | 42U & higher |
| EA-5046-C | EA-5046-E | EA-5046-CE | 30A | L22-30 | (24) C13 + (12) C19 | 17.2 kW | 42U & higher |

Notes: *Shipping weight for each unit is 27 lb (12 kg).

**Redundancy Pack includes 2 PDUs in Black and Glacier White for easy identification of the primary and secondary unit; shipping weight is 54 lb (24 kg).

***Convenience outlets do not provide monitoring or switching capabilities.

| Switched eConnect PDU, Vertical - Worldwide | | | | | | | | |
|--|----------------|-------------------|----------------|-----------------------------------|---------------------|----------------------------|--------------------------------|--------------------|
| Part Number | | | Input Amperage | Input Plug | Outlets | kW Capacity Worldwide (CE) | kW Capacity North America (UL) | Cabinet Capability |
| Black* | Glacier White* | Redundancy Pack** | | | | | | |
| 220 - 240 Volt, Single-Phase Input | | | | | | | | |
| EA-5008-C | EA-5008-E | EA-5008-CE | 16A | C20 Inlet to IEC 60309 16A 1P+N+E | (24) C13 | 3.8 kW | 3.8 kW | 42U & higher |
| EA-5019-C | EA-5019-E | EA-5019-CE | 16A | C20 Inlet to IEC 60309 16A 1P+N+E | (18) C13 + (6) C19 | 3.8 kW | 3.8 kW | 42U & higher |
| EA-5009-C | EA-5009-E | EA-5009-CE | 32A | IEC 60309 32A 1P+N+E | (24) C13 | 7.7 kW | 6.1 kW | 42U & higher |
| EA-5020-C | EA-5020-E | EA-5020-CE | 32A | IEC 60309 32A 1P+N+E | (18) C13 + (6) C19 | 7.7 kW | 6.1 kW | 42U & higher |
| 220-240/380-415 Volt, Three-Phase Input | | | | | | | | |
| EA-5010-C | EA-5010-E | EA-5010-CE | 16/20A | IEC 60309 16/20A 3P+N+E | (24) C13 | 11.5 kW | 11.5 kW | 42U & higher |
| EA-5021-C | EA-5021-E | EA-5021-CE | 16/20A | IEC 60309 16/20A 3P+N+E | (18) C13 + (6) C19 | 11.5 kW | 11.5 kW | 42U & higher |
| EA-5030-C | EA-5030-E | EA-5030-CE | 16/20A | IEC 60309 16/20A 3P+N+E | (12) C13 + (12) C19 | 11.5 kW | 11.5 kW | 42U & higher |
| EA-5039-C | EA-5039-E | EA-5039-CE | 16/20A | IEC 60309 16/20A 3P+N+E | (36) C13 | 11.5 kW | 11.5 kW | 42U & higher |
| EA-5047-C | EA-5047-E | EA-5047-CE | 16/20A | IEC 60309 16/20A 3P+N+E | (24) C13 + (12) C19 | 11.5 kW | 11.5 kW | 42U & higher |
| EA-5022-C | EA-5022-E | EA-5022-CE | 32A | IEC 60309 32A 3P+N+E | (18) C13 + (6) C19 | 23 kW | 18.4 kW | 42U & higher |
| EA-5031-C | EA-5031-E | EA-5031-CE | 32A | IEC 60309 32A 3P+N+E | (12) C13 + (12) C19 | 23 kW | 18.4 kW | 42U & higher |
| EA-5040-C | EA-5040-E | EA-5040-CE | 32A | IEC 60309 32A 3P+N+E | (36) C13 | 23 kW | 18.4 kW | 42U & higher |
| EA-5048-C | EA-5048-E | EA-5048-CE | 32A | IEC 60309 32A 3P+N+E | (24) C13 + (12) C19 | 23 kW | 18.4 kW | 42U & higher |

Notes: * Shipping weight for each unit is 27 lb (12 kg). **Redundancy Pack includes 2 PDUs (one in Black and one in Glacier White) for easy identification of the primary and secondary unit; shipping weight is 54 lb (24 kg).



The Power Selector enables you to select the best power product for your application by narrowing down options based on your requirements. After you're done comparing, you can email or print the results. Visit selectapdu.com to access the Power Selector.



Switched Pro eConnect PDUs provide remote power monitoring and control for each outlet on the PDU, making it possible to remotely measure and cycle power for each piece of equipment attached to the PDU.

Reduced Networking Costs and Complexity

Secure Array® allows the use of a single IP address for up to 48 connected PDUs (32 when electronic locks are integrated). Second IP address for the entire array provides failover capability

Simplified Load Balancing

Phase-balance outlets on three-phase models ensure equal loading across all phases; allows use of shorter equipment power cords for better cable and airflow management

No Accidental Disconnections

Patented, low-profile locking outlets prevent accidental disconnections without requiring special cords

Electronic Lock Integration

Patented technology seamlessly integrates PDU, environmental sensors and electronic locks into a single hardware and software solution

Gigabit Ethernet

Ensures compatibility with enterprise routers and switches

Cabinet Preinstallation

Complete ecosystem ships ready for IT equipment integration. Saves deployment time and reduces packaging waste.

Switched Pro eConnect PDU

Additional Features:

- Individual outlet monitoring and switching; outlet grouping
- Field-replaceable controller module for easy serviceability and upgradeability while maintaining power to critical loads; SD-card transfers PDU configuration
- Bistable latching relays for reduced energy consumption and increased service reliability; maintains last state of power outlet if power is interrupted
- Input and branch circuit monitoring with billing-grade +/-1% accuracy
- Onboard GUI, RESTful API, SNMP v1/v2/v3, Command Line Interface (CLI) and native Power IQ® DCIM software integration allows users to easily manage PDUs
- Zero Touch Provisioning (ZTP) automates configuration and provisioning of large deployments of PDUs.
- HTTP's support, RADIUS and LDAP integration for enhanced authentication and security
- Customization capabilities: outlet configurations, color options, power cord length, input connection types and more
- Made in the United States, TAA-compliant

Specifications:

- Single-input, vertical and horizontal rack-mount PDUs
- Circuit Protection:
 - UL 489 listed, single- or two-pole, hydraulic-magnetic breakers available on single- and three-phase models with 30A and above input
 - 10kAIC breakers on 220-240/380-415 VAC models; 5kAIC for all other models
 - Low-profile design prevents accidental discharge
- Metering:
 - Input line currents
 - Voltage, current, power, energy and power factor at branch circuits and individual outlets
 - +/- 1% billing-grade
 - Ability to name outlets to identify attached equipment
 - Outlet grouping for power charge back reports
- Switching:
 - Ability to turn on/off and cycle power to individual or group of outlets using bistable latching relays
 - Ability to name individual outlets to identify attached equipment
 - Status indicator LED light for individual outlets
 - Grouping of outlets for consolidated power control
- Console Access:
 - Through serial console port connection and Command Line Interface (CLI)
- Controller:
 - Field-replaceable module; SD-card transfers PDU configuration
- Firmware:
 - Flash upgradeable through USB port, Web interface, CLI, API or Power IQ
- Electronic Lock Integration:
 - Front and rear cabinet door locks (ordered separately) connected to ports on PDU
 - Door locks are powered from and remotely accessed through the PDU
- Mounting:
 - Vertical PDUs: 2 preinstalled tool-less mounting buttons; adjustable positions; Top or bottom power cord entry orientation
- Dimensions:
 - For specific dimensions, download the individual product cut sheets by searching the base part number (ex: Ex-xxxx) on chatsworth.com

Certifications:

- UL/cUL/IEC62368, CE (EU), FCC Part 15, Class A, EN 55022, RoHS Compliant

| Switched Pro eConnect PDU, Vertical - North America | | | | | | | |
|---|----------------|-------------------|----------------|--------------------|--|------------------|--------------------|
| Part Number | | | Input Amperage | Input Plug | Outlets | kW Capacity (UL) | Cabinet Capability |
| Black* | Glacier White* | Redundancy Pack** | | | | | |
| 120 Volt, Single-Phase Input | | | | | | | |
| EA-6001-C | EA-6001-E | EA-6001-CE | 20A | C20 Inlet to L5-20 | (24) 5-20 | 1.9 kW | 42U & higher |
| EA-6002-C | EA-6002-E | EA-6002-CE | 30A | L5-30 | (24) 5-20 | 2.9 kW | 42U & higher |
| 208 Volt, Single-Phase Input | | | | | | | |
| EA-6069-C | EA-6069-E | EA-6069-CE | 20A | C20 Inlet to L6-20 | (18) C13 + (6) C19 | 3.3 kW | 42U & higher |
| EA-6070-C | EA-6070-E | EA-6070-CE | 20A | C20 Inlet to L6-20 | (24) C13 | 3.3 kW | 42U & higher |
| EA-6004-C | EA-6004-E | EA-6004-CE | 30A | L6-30 | (24) C13 | 5 kW | 42U & higher |
| EA-6012-C | EA-6012-E | EA-6012-CE | 30A | L6-30 | (18) C13 + (6) C19 | 5 kW | 42U & higher |
| 120/208 Volt, Three-Phase Input | | | | | | | |
| EA-6006-C | EA-6006-E | EA-6006-CE | 20A | L21-20 | (24) C13 | 5.7 kW | 42U & higher |
| EA-6014-C | EA-6014-E | EA-6014-CE | 20A | L21-20 | (18) C13 + (6) C19 | 5.7 kW | 42U & higher |
| EA-6025-C | EA-6025-E | EA-6025-CE | 20A | L21-20 | (18) C13 + (6) C19 Outlets + (3) 5-20 Convenience Outlets*** | 5.7 kW | 42U & higher |
| EA-6007-C | EA-6007-E | EA-6007-CE | 30A | L21-30 | (24) C13 | 8.6 kW | 42U & higher |
| EA-6015-C | EA-6015-E | EA-6015-CE | 30A | L21-30 | (18) C13 + (6) C19 | 8.6 kW | 42U & higher |
| EA-6026-C | EA-6026-E | EA-6026-CE | 30A | L21-30 | (18) C13 + (6) C19 Outlets + (3) 5-20 Convenience Outlets*** | 8.6 kW | 42U & higher |
| EA-6035-C | EA-6035-E | EA-6035-CE | 30A | L21-30 | (36) C13 | 8.6 kW | 42U & higher |
| 208 Volt, Three-Phase Input | | | | | | | |
| EA-6005-C | EA-6005-E | EA-6005-CE | 30A | L15-30 | (24) C13 | 8.6 kW | 42U & higher |
| EA-6013-C | EA-6013-E | EA-6013-CE | 30A | L15-30 | (18) C13 + (6) C19 | 8.6 kW | 42U & higher |
| EA-6034-C | EA-6034-E | EA-6034-CE | 30A | L15-30 | (36) C13 | 8.6 kW | 42U & higher |
| EA-6016-C | EA-6016-E | EA-6016-CE | 50A | CS8365 | (18) C13 + (6) C19 | 14.4 kW | 42U & higher |
| EA-6027-C | EA-6027-E | EA-6027-CE | 50A | CS8365 | (12) C13 + (12) C19 | 14.4 kW | 42U & higher |
| EA-6136-C | EA-6136-E | EA-6136-CE | 50A | CS8365 | (36) C13 | 14.4 kW | 45U & higher |
| EA-6144-C | EA-6144-E | EA-6144-CE | 50A | CS8365 | (24) C13 + (12) C19 | 14.4 kW | 45U & higher |
| EA-6017-C | EA-6017-E | EA-6017-CE | 60A | IEC 60309 60A 3P+E | (18) C13 + (6) C19 | 17.2 kW | 42U & higher |
| EA-6028-C | EA-6028-E | EA-6028-CE | 60A | IEC 60309 60A 3P+E | (12) C13 + (12) C19 | 17.2 kW | 42U & higher |
| EA-6137-C | EA-6137-E | EA-6137-CE | 60A | IEC 60309 60A 3P+E | (36) C13 | 17.2 kW | 45U & higher |
| EA-6145-C | EA-6145-E | EA-6145-CE | 60A | IEC 60309 60A 3P+E | (24) C13 + (12) C19 | 17.2 kW | 45U & higher |
| 240/415 Volt, Three-Phase Input | | | | | | | |
| EA-6018-C | EA-6018-E | EA-6018-CE | 30A | L22-30 | (18) C13 + (6) C19 | 17.2 kW | 42U & higher |
| EA-6029-C | EA-6029-E | EA-6029-CE | 30A | L22-30 | (12) C13 + (12) C19 | 17.2 kW | 42U & higher |
| EA-6038-C | EA-6038-E | EA-6038-CE | 30A | L22-30 | (36) C13 | 17.2 kW | 42U & higher |
| EA-6046-C | EA-6046-E | EA-6046-CE | 30A | L22-30 | (24) C13 + (12) C19 | 17.2 kW | 42U & higher |

Notes: *Shipping weight for each unit is 27 lb (12 kg).

**Redundancy Pack includes 2 PDUs in Black and Glacier White for easy identification of the primary and secondary unit; shipping weight is 54 lb (24 kg).

***Convenience outlets do not provide monitoring or switching capabilities.



The Power Selector enables you to select the best power product for your application by narrowing down options based on your requirements. After you're done comparing, you can email or print the results. Visit selectapdu.com to access the Power Selector.

| Switched Pro eConnect PDU, Vertical - Worldwide | | | | | | | | |
|---|----------------|-------------------|----------------|--------------------------------------|---------------------|----------------------------|--------------------------------|--------------------|
| Part Number | | | Input Amperage | Input Plug | Outlets | kW Capacity Worldwide (CE) | kW Capacity North America (UL) | Cabinet Capability |
| Black* | Glacier White* | Redundancy Pack** | | | | | | |
| 220 - 240 Volt, Single-Phase Input | | | | | | | | |
| EA-6008-C | EA-6008-E | EA-6008-CE | 16/20A | C20 Inlet to IEC 60309 16/20A 1P+N+E | (24) C13 | 3.8 kW | 3.8 kW | 42U & higher |
| EA-6019-C | EA-6019-E | EA-6019-CE | 16/20A | C20 Inlet to IEC 60309 16/20A 1P+N+E | (18) C13 + (6) C19 | 3.8 kW | 3.8 kW | 42U & higher |
| EA-6009-C | EA-6009-E | EA-6009-CE | 32A | IEC 60309 32A 1P+N+E | (24) C13 | 7.7 kW | 6.1 kW | 42U & higher |
| EA-6020-C | EA-6020-E | EA-6020-CE | 32A | IEC 60309 32A 1P+N+E | (18) C13 + (6) C19 | 7.7 kW | 6.1 kW | 42U & higher |
| 220-240/380-415 Volt, Three-Phase Input | | | | | | | | |
| EA-6010-C | EA-6010-E | EA-6010-CE | 16/20A | IEC 60309 16/20A 3P+N+E | (24) C13 | 11.5 kW | 11.5 kW | 42U & higher |
| EA-6021-C | EA-6021-E | EA-6021-CE | 16/20A | IEC 60309 16/20A 3P+N+E | (18) C13 + (6) C19 | 11.5 kW | 11.5 kW | 42U & higher |
| EA-6030-C | EA-6030-E | EA-6030-CE | 16/20A | IEC 60309 16/20A 3P+N+E | (12) C13 + (12) C19 | 11.5 kW | 11.5 kW | 42U & higher |
| EA-6039-C | EA-6039-E | EA-6039-CE | 16/20A | IEC 60309 16/20A 3P+N+E | (36) C13 | 11.5 kW | 11.5 kW | 42U & higher |
| EA-6047-C | EA-6047-E | EA-6047-CE | 16/20A | IEC 60309 16/20A 3P+N+E | (24) C13 + (12) C19 | 11.5 kW | 11.5 kW | 42U & higher |
| EA-6022-C | EA-6022-E | EA-6022-CE | 32A | IEC 60309 32A 3P+N+E | (18) C13 + (6) C19 | 23 kW | 18.4 kW | 42U & higher |
| EA-6031-C | EA-6031-E | EA-6031-CE | 32A | IEC 60309 32A 3P+N+E | (12) C13 + (12) C19 | 23 kW | 18.4 kW | 42U & higher |
| EA-6040-C | EA-6040-E | EA-6040-CE | 32A | IEC 60309 32A 3P+N+E | (36) C13 | 23 kW | 18.4 kW | 42U & higher |
| EA-6048-C | EA-6048-E | EA-6048-CE | 32A | IEC 60309 32A 3P+N+E | (24) C13 + (12) C19 | 23 kW | 18.4 kW | 42U & higher |

Notes: * Shipping weight for each unit is 27 lb (12 kg).

**Redundancy Pack includes 2 PDUs (one in Black and one in Glacier White) for easy identification of the primary and secondary unit; shipping weight is 54 lb (24 kg).

PDU Accessories



USB Temperature and Humidity Sensor

Attaches to the USB port on the eConnect PDUs.

| Part Number | Description | Shipping Weight lb (kg) |
|-------------|-------------------------------------|-------------------------|
| 14665-001 | USB Temperature and Humidity Sensor | 3 (1.4) |



14676-001



14812-001

Field-Replaceable Controller Module

Field-replaceable controller module for eConnect® Power Distribution Unit (PDU). Compatible with eConnect Monitored, Monitored Pro, Switched or Switched Pro eConnect PDUs. Allows replacement of controller module while maintaining power to critical loads. Ability to use an SD-card to transfer PDU configuration. Available in two options, to match to either a Vertical or Horizontal eConnect PDU form factor. Both controller modules include connections for ethernet, Secure Array IP Consolidation, temperature and humidity sensors, RFID Electronic Locks and serial/console interface. Controller module for Vertical eConnect PDUs also includes a local display.

| Part Number | Description | Shipping Weight lb (kg) |
|-------------|---|-------------------------|
| 14676-001 | eConnect Controller 4 (MCM4) for Vertical eConnect PDUs | 1 (0.5) |
| 14812-001 | eConnect Controller 4 (MCM4) for Horizontal eConnect PDUs | 1 (0.5) |

Note: Compatible with PDU P/Ns: EA-3xxx, EA-4xxx, EA-5xxx, EA-6xxx.



eConnect® RFID Electronic Lock Kit

Integrate cabinet access control along with power management and environmental monitoring under a single network connection, one user interface and one user database for dramatically reduced deployment savings. Fully compatible with DCIM software. Available on Monitored, Monitored Pro, Switched and Switched Pro eConnect PDUs

| Part Number | Description | Shipping Weight lb (kg) |
|-------------|--|-------------------------|
| 14666-001 | eConnect® RFID Electronic Lock Kit For ZetaFrame | 3 (1.4) |



Extended Limited Warranties

Extended Limited Warranties on CPI-Branded Electronic products, available for two additional years beyond the expiration of the Original Warranty Period (3 years).

Contact CPI Customer Service, or visit chatsworth.com/warranty for more information.

| Part Number | Description |
|---------------------------|--|
| L1-2YEXTWAR-ELECTRONICS-C | 2-Year Warranty Extension for PDUs with MSRP up to \$1700 |
| L2-2YEXTWAR-ELECTRONICS-C | 2-Year Warranty Extension for PDUs with MSRP \$1701 - \$3400 |
| L3-2YEXTWAR-ELECTRONICS-C | 2-Year Warranty Extension for PDUs with MSRP > \$3400 |

Power IQ for eConnect PDUs

Features:

- Vendor-agnostic tool that provides monitoring, logging and charting of a variety of data center assets (health map, trend analysis, capacity forecast, power chargeback reports, and more)
- Power Usage Effectiveness (PUE) gauge and chart
- Centralized power control of all IT assets connected to Switched and Switched Pro PDUs
- Centralized grouping capabilities of outlets, PDUs and other equipment
- Automated emails alerts for quick identification of hotspots and other threshold violations
- Full support of CPI Secure Array technology, which allows you to achieve 90% reduction in rack PDU networking costs by supporting IP consolidation and failover capability
- Constant synchronization of data between eConnect PDUs and PIQ software
- Easy integration into third party applications through Web APIs
- Easy integration of SNMP enabled hardware devices through Dynamic plugins

| Part Number | Power IQ for eConnect - Software and License, With One (1) Year Maintenance Plan |
|-------------|--|
| 36603-001 | Software and License for up to 10 Devices |
| 36603-002 | Software and License for up to 20 Devices |
| 36603-005 | Software and License for up to 50 Devices |
| 36603-010 | Software and License for up to 100 Devices |
| 36603-020 | Software and License for up to 200 Devices |
| 36603-030 | Software and License for up to 300 Devices |
| 36603-040 | Software and License for up to 400 Devices |
| 36603-050 | Software and License for up to 500 Devices |

| Part Number | Power IQ for eConnect - Support Services |
|-------------|---|
| 36605-001 | 1-Hour of Professional Service |
| 36605-002 | 1-Day Quick-Start Service |
| 36605-003 | Dynamic Plug-In, Developed, Certified and Tested by Professional Services |



| Part Number | Power IQ for eConnect - Additional Device Licenses |
|-------------|--|
| 36604-001 | Additional License for up to 10 Devices |
| 36604-002 | Additional License for up to 20 Devices |
| 36604-005 | Additional License for up to 50 Devices |
| 36604-010 | Additional License for up to 100 Devices |

| Part Number | Power IQ for eConnect - Server Hardware |
|-------------|--|
| 36516-002 | Power IQ for eConnect software, 39 lb (18 kg) Pre-installed on 1U Configured Dual Power Supply Server, 1 Year Support and Maintenance, Includes Rail Kit |







Outlet and Input Plug Table

Power Receptacles/Outlets









| | | |
|---|---|---|
|  |  |  |
| NEMA 5-20R 120 VAC/20A | IEC320 C13 UL: 120/208VAC/15A CE: 208VAC/10A | IEC320 C19 UL: 120/208VAC/20A CE: 208VAC/16A |

Power Plugs:







NEMA, Single-Phase Locking

| | | | |
|---|---|---|---|
|  |  |  |  |
| NEMA L5-20P 110-125VAC/20A | NEMA L5-30P 110-125VAC/30A | NEMA L6-20P 200-240VAC/20A | NEMA L6-30P 200-240VAC/30A |

Three-Phase/Locking

| | | | | | | | |
|---|---|---|---|---|---|---|--|
|  |  |  |  |  |  |  |  |
| NEMA L15-20P 208 VAC/20A | NEMA L15-30P 208 VAC/30A | NEMA L21-20P 120/208 VAC/20A | NEMA L21-30P 120/208 VAC/30A | NEMA L22-20P 380-415 VAC/20A | NEMA L22-30P 380-415 VAC/30A | 50A CS8365C 208 VAC/50A* | 60A CS8365 208 VAC/60A* |

Power Inlet - Universal/Locking

| | | | | | |
|---|---|---|---|---|---|
|  |  |  |  |  |  |
| IEC C20 110/125 VAC/20A | IEC C20 200/240 VAC/20A | IEC 16A 1P+N+E 200/240 VAC/16A | IEC 32A 1P+N+E 200/240 VAC/32A | IEC 16A 3P+N+E 230/400 VAC/16A | IEC 32A 3P+N+E 230/400 VAC/32A |

* Note: 50A CS8365 is rated for 50A, but maximum input is 35A on three breaker PDUs.



The Power Selector enables you to select the best power product for your application by narrowing down options based on your requirements. After you're done comparing, you can email or print the results. Visit selectapdu.com to access the Power Selector.

Power Strips

Power Strips distribute basic, single-phase power to multiple pieces of equipment from a single power connection and provide optional features for local metering.

- NEMA-style outlets and plugs
- Includes a thermal circuit breaker to protect circuits from overload
- Available with surge-protection to protect equipment from power spikes and local meters to provide easy voltage and current monitoring

| Part Number | Input | | | Output | | Dims - in (mm) | | |
|--|-------|-----|-------------|----------|------------|----------------|----------|----------|
| | Amp | kW | Plug | Breakers | Outlets | H | W | D |
| 110-120 Volt, Single-Phase Power Strip | | | | | | | | |
| 12850-701 | 20 | 1.4 | NEMA 5-15P | 1 x 20A | (14) 5-20R | 33.0 (838) | 1.7 (43) | 1.7 (43) |
| 12848-701 | 15 | 1.4 | NEMA 5-15P | 1 x 20A | (24) 5-20R | 66.0 (1676) | 1.7 (43) | 1.7 (43) |
| 12850-703 | 20 | 1.4 | NEMA L5-15P | 1 x 20A | (14) 5-20R | 33.0 (838) | 1.7 (43) | 1.7 (43) |
| 12848-703 | 15 | 1.4 | NEMA L5-15P | 1 x 20A | (24) 5-20R | 66.0 (1676) | 1.7 (43) | 1.7 (43) |
| 12850-705 | 20 | 1.9 | NEMA 5-20P | 1 x 20A | (14) 5-20R | 33.0 (838) | 1.7 (43) | 1.7 (43) |
| 12848-705 | 20 | 1.9 | NEMA 5-20P | 1 x 20A | (24) 5-20R | 66.0 (1676) | 1.7 (43) | 1.7 (43) |
| 12850-707 | 20 | 1.9 | NEMA L5-20P | 1 x 20A | (14) 5-20R | 33.0 (838) | 1.7 (43) | 1.7 (43) |
| 12848-707 | 20 | 1.9 | NEMA L5-20P | 1 x 20A | (24) 5-20R | 66.0 (1676) | 1.7 (43) | 1.7 (43) |
| 110-120 Volt, Single-Phase Power Strip, Surge-Protected | | | | | | | | |
| 12850-702 | 15 | 1.4 | NEMA 5-15P | 1 x 20A | (14) 5-20R | 33.0 (838) | 1.7 (43) | 1.7 (43) |
| 12848-702 | 15 | 1.4 | NEMA 5-15P | 1 x 20A | (24) 5-20R | 66.0 (1676) | 1.7 (43) | 1.7 (43) |
| 12850-704 | 15 | 1.4 | NEMA L5-15P | 1 x 20A | (14) 5-20R | 33.0 (838) | 1.7 (43) | 1.7 (43) |
| 12848-704 | 15 | 1.4 | NEMA L5-15P | 1 x 20A | (24) 5-20R | 66.0 (1676) | 1.7 (43) | 1.7 (43) |
| 12850-706 | 20 | 1.9 | NEMA 5-20P | 1 x 20A | (14) 5-20R | 33.0 (838) | 1.7 (43) | 1.7 (43) |
| 12848-706 | 20 | 1.9 | NEMA 5-20P | 1 x 20A | (24) 5-20R | 66.0 (1676) | 1.7 (43) | 1.7 (43) |
| 12850-708 | 20 | 1.9 | NEMA L5-20P | 1 x 20A | (14) 5-20R | 33.0 (838) | 1.7 (43) | 1.7 (43) |
| 12848-708 | 20 | 1.9 | NEMA L5-20P | 1 x 20A | (24) 5-20R | 66.0 (1676) | 1.7 (43) | 1.7 (43) |

Notes: Input current is the breaker rating. The Input Amp column lists the maximum rated value of the Input Plug/inlet and circuit breaker rating.

UL/NEC regulatory code requires current ratings on product labels to be derated to 80% of the maximum rated values (for example: 20 Amp = 16 Amp on UL product label). For the Input kW column, all values are derated calculations per UL for use in North America. Input kW is the listed rating. Includes rack mounting brackets and tool-less hardware. All power strips have IEC C20 inlets and include a power cord. Cords with locking plugs are 10' (3 m). Cords with straight plugs are 8'2" (2.4 m). Order mounting brackets for cabinets separately.

Metered Power Strips, Vertical Mount

| Part Number | Input | | | Output | | Dims - in (mm) | | |
|--|-------|-----|-------------|----------|------------|----------------|----------|----------|
| | Amp | kW | Plug | Breakers | Outlets | H | W | D |
| 110-120 Volt, Single-Phase Power Strip | | | | | | | | |
| 12848-751 | 15 | 1.4 | NEMA 5-15P | 1 x 20A | (24) 5-20R | 66.0 (1676) | 1.7 (43) | 1.7 (43) |
| 12848-755 | 20 | 1.9 | NEMA 5-20P | 1 x 20A | (24) 5-20R | 66.0 (1676) | 1.7 (43) | 1.7 (43) |
| 12848-757 | 20 | 1.9 | NEMA L5-20P | 1 x 20A | (24) 5-20R | 66.0 (1676) | 1.7 (43) | 1.7 (43) |
| 110-120 Volt, Single-Phase Power Strip, Surge-Protected | | | | | | | | |
| 12848-752 | 15 | 1.4 | NEMA 5-15P | 1 x 20A | (24) 5-20R | 66.0 (1676) | 1.7 (43) | 1.7 (43) |
| 12848-754 | 15 | 1.4 | NEMA L5-15P | 1 x 20A | (24) 5-20R | 66.0 (1676) | 1.7 (43) | 1.7 (43) |
| 12848-756 | 20 | 1.9 | NEMA 5-20P | 1 x 20A | (24) 5-20R | 66.0 (1676) | 1.7 (43) | 1.7 (43) |
| 12848-758 | 20 | 1.9 | NEMA L5-20P | 1 x 20A | (24) 5-20R | 66.0 (1676) | 1.7 (43) | 1.7 (43) |

Notes: Input current is the breaker rating. The Input Amp column lists the maximum rated value of the Input Plug/inlet and circuit breaker rating.

UL/NEC regulatory code requires current ratings on product labels to be derated to 80% of the maximum rated values (for example: 20 Amp = 16 Amp on UL product label). For the Input kW column, all values are derated calculations per UL for use in North America. Input kW is the listed rating. Includes rack mounting brackets and tool-less hardware. All power strips have IEC C20 inlets and include a power cord. Cords with locking plugs are 10' (3 m). Cords with straight plugs are 8'2" (2.4 m). Order mounting brackets for cabinets separately.

Basic Power Strips, Horizontal Rack-Mount

| Part Number | Input | | | Output | | Dims - in (mm) | | |
|--|-------|-----|-------------|----------|-----------|----------------|------------|----------|
| | Amp | kW | Plug | Breakers | Outlets | H | W | D |
| 110-120 Volt, Single-Phase Power Strip | | | | | | | | |
| 12816-701 | 15 | 1.4 | NEMA 5-15P | 1 x 20A | (8) 5-20R | 1U | 19"EIA/23" | 1.4 (36) |
| 12816-702 | 15 | 1.4 | NEMA L5-15P | 1 x 20A | (8) 5-20R | 1U | 19"EIA/23" | 1.4 (36) |
| 12816-705 | 20 | 1.9 | NEMA 5-20P | 1 x 20A | (8) 5-20R | 1U | 19"EIA/23" | 1.4 (36) |
| 12816-706 | 20 | 1.9 | NEMA L5-20P | 1 x 20A | (8) 5-20R | 1U | 19"EIA/23" | 1.4 (36) |
| 110-120 Volt, Single-Phase Power Strip, Surge-Protected | | | | | | | | |
| 12816-703 | 15 | 1.4 | NEMA 5-15P | 1 x 20A | (6) 5-20R | 1U | 19"EIA/23" | 1.4 (36) |
| 12816-704 | 15 | 1.4 | NEMA L5-15P | 1 x 20A | (6) 5-20R | 1U | 19"EIA/23" | 1.4 (36) |
| 12816-707 | 20 | 1.9 | NEMA 5-20P | 1 x 20A | (6) 5-20R | 1U | 19"EIA/23" | 1.4 (36) |
| 12816-708 | 20 | 1.9 | NEMA L5-20P | 1 x 20A | (6) 5-20R | 1U | 19"EIA/23" | 1.4 (36) |

Notes: Input current is the breaker rating. The Input Amp column lists the maximum rated value of the Input Plug/inlet and circuit breaker rating. UL/NEC regulatory code requires current ratings on product labels to be derated to 80% of the maximum rated values (for example: 20 Amp = 16 Amp on UL product label). For the Input kW column, all values are derated calculations per UL for use in North America. Input kW is the listed rating. Includes 19"EIA and 23"W horizontal rack-mount brackets. All power strips have IEC C20 inlets and include a power cord. Cords with locking plugs are 10'L (3 m). Cords with straight plugs are 8'2"L (2.4 m).

Metered Power Strips, Horizontal Rack-Mount

| Part Number | Input | | | Output | | Dims - in (mm) | | |
|--|-------|-----|-------------|----------|------------|----------------|--------|-----------|
| | Amp | kW | Plug | Breakers | Outlets | H | W | D |
| 110-125 Volt, Single-Phase Power Strip | | | | | | | | |
| 13239-751 | 15 | 1.4 | NEMA 5-15P | 1 x 20A | (12) 5-20R | 1U | 19"EIA | 4.6 (117) |
| 13239-755 | 20 | 1.9 | NEMA 5-20P | 1 x 20A | (12) 5-20R | 1U | 19"EIA | 4.6 (117) |
| 13239-756 | 20 | 1.9 | NEMA L5-20P | 1 x 20A | (12) 5-20R | 1U | 19"EIA | 4.6 (117) |
| 110-125 Volt, Single-Phase Power Strip, Surge-Protected | | | | | | | | |
| 13239-753 | 15 | 1.4 | NEMA 5-15P | 1 x 20A | (12) 5-20R | 1U | 19"EIA | 4.6 (117) |
| 13239-757 | 20 | 1.9 | NEMA 5-20P | 1 x 20A | (12) 5-20R | 1U | 19"EIA | 4.6 (117) |
| 13239-758 | 20 | 1.9 | NEMA L5-20P | 1 x 20A | (12) 5-20R | 1U | 19"EIA | 4.6 (117) |

Notes: Input current is the breaker rating. The Input Amp column lists the maximum rated value of the Input Plug/inlet and circuit breaker rating. UL/NEC regulatory code requires current ratings on product labels to be derated to 80% of the maximum rated values (for example: 20 Amp = 16 Amp on UL product label). For the Input kW column, all values are derated calculations per UL for use in North America. Input kW is the listed rating. Includes 19"EIA and 23"W horizontal rack-mount brackets. All power strips have IEC C20 inlets and include a power cord. Cords with locking plugs are 10'L (3 m). Cords with straight plugs are 8'2"L (2.4 m).

Basic Power Strips for CUBE-iT® Cabinets

| Part Number | Input | | | Output | | Dims - in (mm) | | |
|--|-------|-----|-------------|----------|-----------|----------------|----------|-----------|
| | Amp | kW | Plug | Breakers | Outlets | H | W | D |
| 110-120 Volt, Single-Phase Power Strip | | | | | | | | |
| 12820-701 | 15 | 1.4 | NEMA 5-15P | 1 x 20A | (8) 5-20R | 19.2 (488) | 1.8 (44) | 8.2 (208) |
| 12820-702 | 15 | 1.4 | NEMA L5-15P | 1 x 20A | (8) 5-20R | 19.2 (488) | 1.8 (44) | 8.2 (208) |
| 12820-705 | 20 | 1.9 | NEMA 5-20P | 1 x 20A | (8) 5-20R | 19.2 (488) | 1.8 (44) | 8.2 (208) |
| 12820-706 | 20 | 1.9 | NEMA L5-20P | 1 x 20A | (8) 5-20R | 19.2 (488) | 1.8 (44) | 8.2 (208) |
| 110-120 Volt, Single-Phase Power Strip, Surge-Protected | | | | | | | | |
| 12820-703 | 15 | 1.4 | NEMA 5-15P | 1 x 20A | (6) 5-20R | 19.2 (488) | 1.8 (44) | 8.2 (208) |
| 12820-704 | 15 | 1.4 | NEMA L5-15P | 1 x 20A | (6) 5-20R | 19.2 (488) | 1.8 (44) | 8.2 (208) |
| 12820-707 | 20 | 1.9 | NEMA 5-20P | 1 x 20A | (6) 5-20R | 19.2 (488) | 1.8 (44) | 8.2 (208) |
| 12820-708 | 20 | 1.9 | NEMA L5-20P | 1 x 20A | (6) 5-20R | 19.2 (488) | 1.8 (44) | 8.2 (208) |

Notes: Dimensions include mounting bracket in vertical orientation. The Power Strip is 17"H (432 mm) x 1.7"W (43 mm) x 1.4"D (36 mm). All power strips have IEC C20 inlets and include a power cord. Cords with locking plugs are 10'L (3 m). Cords with straight plugs are 8'2"L (2.4 m).

International Power Strips

Specifications:

- **Circuit Control:**
 - Master lighted switch on horizontal rack-mount power strips
- **Circuit Protection:**
 - Thermal circuit breakers on vertical mount power strips
- **Optional Surge Protection**
 - 330 Volt, 1100 Joules
 - Surge suppression active indicator LED
- **Current Metering:**
 - Digital voltage and ammeter included on metered power strips
 - Meter has a 3-digit LED display
 - Overload alarm/flashing LED at breaker rating
- **Mounting hardware/brackets:**
 - Horizontal rack-mount power strips include mounting brackets for 19"W EIA and 23"W racks
 - Vertical mount power strips include tool-less buttons; order mounting brackets separately





Certifications:

- CE Marked









International Power Strip Plug & Receptacle/Outlet Table

Plug & Receptacle Configurations Plug Inlet, Universal/Locking

| | | | |
|---|---|---|---|
|  |  |  |  |
| IEC C20 220-250 VAC/16A | IEC 16A 1P+N+E 220-250 VAC/16A | IEC 32A 1P+N+E 220-250 VAC/32A | BS 1363 (UK) 220-250 VAC/13A |

Power Receptacle/Outlet Table: Receptacles/Outlets

| | | | | | | |
|---|---|---|---|---|---|---|
|  |  |  |  |  |  |  |
| IEC C13 220-250 VAC/10A | IEC C19 220-250 VAC/16A | BS 1363 (UK) 220-250 VAC/13A | Schuko DIN49440 220-250 VAC/16A | Universal GB2009.3 220-250 VAC/10A | CH GB1002 220-250 VAC/10A | CH GB1002 220-250 VAC/16A |

Basic Power Strips, Vertical Mount

| Part Number | Input | | | Output | | Dims - in (mm) | | |
|--|-------|-----|----------------|----------|-----------------------------|----------------|----------|----------|
| | Amp | kW* | Plug | Breakers | Outlets | H | W | D |
| 220-250 Volt, Single-Phase Power Strip | | | | | | | | |
| 15642-202 | 16 | 4.0 | IEC C20 | 1 x 16A | (10) C13, (4) C19 | 43.1 (1095) | 2.5 (64) | 1.8 (46) |
| 15642-206 | 16 | 4.0 | IEC C20 | 1 x 16A | (12) UK BS1363 13A | 48.3 (1227) | 2.5 (64) | 1.8 (46) |
| 15642-212 | 16 | 4.0 | IEC 16A 1P+N+E | 1 x 16A | (10) C13, (4) C19 | 43.1 (1095) | 2.5 (64) | 1.8 (46) |
| 15642-216 | 16 | 4.0 | IEC 16A 1P+N+E | 1 x 16A | (12) UK BS1363 13A | 48.3 (1227) | 2.5 (64) | 1.8 (46) |
| 15642-222 | 32 | 8.0 | IEC 32A 1P+N+E | 2 x 16A | (10) C13, (4) C19 | 48.3 (1227) | 2.5 (64) | 1.8 (46) |
| 15642-226 | 32 | 8.0 | IEC 32A 1P+N+E | 2 x 16A | (12) UK BS1363 13A | 53.4 (1357) | 2.5 (64) | 1.8 (46) |
| 15642-232 | 13 | 3.3 | UK BS1363 | 1 x 13A | (10) C13, (4) C19 | 43.1 (1095) | 2.5 (64) | 1.8 (46) |
| 15642-236 | 13 | 3.3 | UK BS1363 | 1 x 13A | (12) UK BS1363 13A | 48.3 (1227) | 2.5 (64) | 1.8 (46) |
| 15644-202 | 16 | 4.0 | IEC C20 | 1 x 16A | (20) C13, (4) C19 | 61.3 (1557) | 2.5 (64) | 1.8 (46) |
| 15644-205 | 16 | 4.0 | IEC C20 | 1 x 16A | (24) Schuko DIN49440 16A | 61.0 (1549) | 1.8 (46) | 2.7 (69) |
| 15644-207 | 16 | 4.0 | IEC C20 | 1 x 16A | (24) Universal GB2009.3 10A | 61.3 (1557) | 2.5 (64) | 1.8 (46) |
| 15644-208 | 16 | 4.0 | IEC C20 | 1 x 16A | (20) CH GB1002 10A, (4) 16A | 61.3 (1557) | 2.5 (64) | 1.8 (46) |
| 15644-212 | 16 | 4.0 | IEC 16A 1P+N+E | 1 x 16A | (20) C13, (4) C19 | 61.3 (1557) | 2.5 (64) | 1.8 (46) |
| 15644-215 | 16 | 4.0 | IEC 16A 1P+N+E | 1 x 16A | (24) Schuko DIN49440 16A | 61.0 (1549) | 1.8 (46) | 2.7 (69) |
| 15644-217 | 16 | 4.0 | IEC 16A 1P+N+E | 1 x 16A | (24) Universal GB2009.3 10A | 61.3 (1557) | 2.5 (64) | 1.8 (46) |
| 15644-218 | 16 | 4.0 | IEC 16A 1P+N+E | 1 x 16A | (20) CH GB1002 10A, (4) 16A | 61.3 (1557) | 2.5 (64) | 1.8 (46) |
| 15644-222 | 32 | 8.0 | IEC 32A 1P+N+E | 2 x 16A | (20) C13, (4) C19 | 66.5 (1689) | 2.5 (64) | 1.8 (46) |
| 15644-225 | 32 | 8.0 | IEC 32A 1P+N+E | 2 x 16A | (24) Schuko DIN49440 16A | 64.8 (1646) | 1.8 (46) | 2.7 (69) |
| 15644-227 | 32 | 8.0 | IEC 32A 1P+N+E | 2 x 16A | (24) Universal GB2009.3 10A | 66.5 (1689) | 2.5 (64) | 1.8 (46) |
| 15644-228 | 32 | 8.0 | IEC 32A 1P+N+E | 2 x 16A | (20) CH GB1002 10A, (4) 16A | 66.5 (1689) | 2.5 (64) | 1.8 (46) |
| 15644-232 | 13 | 3.3 | UK BS1363 | 1 x 13A | (20) C13, (4) C19 | 61.3 (1557) | 2.5 (64) | 1.8 (46) |
| 15644-237 | 13 | 3.3 | UK BS1363 | 1 x 13A | (24) Universal GB2009.3 10A | 61.3 (1557) | 2.5 (64) | 1.8 (46) |
| 220-250 Volt, Single-Phase Power Strip, Surge-Protected | | | | | | | | |
| 15642-102 | 16 | 4.0 | IEC C20 | 1 x 16A | (10) C13, (4) C19 | 43.1 (1095) | 2.5 (64) | 1.8 (46) |
| 15642-106 | 16 | 4.0 | IEC C20 | 1 x 16A | (12) UK BS1363 13A | 48.3 (1227) | 2.5 (64) | 1.8 (46) |
| 15642-112 | 16 | 4.0 | IEC 16A 1P+N+E | 1 x 16A | (10) C13, (4) C19 | 43.1 (1095) | 2.5 (64) | 1.8 (46) |
| 15642-116 | 16 | 4.0 | IEC 16A 1P+N+E | 1 x 16A | (12) UK BS1363 13A | 48.3 (1227) | 2.5 (64) | 1.8 (46) |
| 15642-122 | 32 | 8.0 | IEC 32A 1P+N+E | 2 x 16A | (10) C13, (4) C19 | 48.3 (1227) | 2.5 (64) | 1.8 (46) |
| 15642-126 | 32 | 8.0 | IEC 32A 1P+N+E | 2 x 16A | (12) UK BS1363 13A | 53.4 (1357) | 2.5 (64) | 1.8 (46) |
| 15642-132 | 13 | 3.3 | UK BS1363 | 1 x 13A | (10) C13, (4) C19 | 43.1 (1095) | 2.5 (64) | 1.8 (46) |
| 15642-136 | 13 | 3.3 | UK BS1363 | 1 x 13A | (12) UK BS1363 13A | 48.3 (1227) | 2.5 (64) | 1.8 (46) |

Notes: All power strips have attached 10'L (3 m) power cord. *kW values are at a Nominal voltage of 250V.



15644-222 shown

Basic Power Strips, Vertical Mount

| Part Number | Input | | | Output | | Dims - in (mm) | | |
|--|-------|-----|----------------|----------|-----------------------------|----------------|----------|----------|
| | Amp | kW* | Plug | Breakers | Outlets | H | W | D |
| 220-250 Volt, Single-Phase Power Strip, Surge-Protected | | | | | | | | |
| 15644-102 | 16 | 4.0 | IEC C20 | 1 x 16A | (20) C13, (4) C19 | 61.3 (1557) | 2.5 (64) | 1.8 (46) |
| 15644-105 | 16 | 4.0 | IEC C20 | 1 x 16A | (24) Schuko DIN49440 16A | 61.0 (1549) | 1.8 (46) | 2.7 (69) |
| 15644-107 | 16 | 4.0 | IEC C20 | 1 x 16A | (24) Universal GB2009.3 10A | 61.3 (1557) | 2.5 (64) | 1.8 (46) |
| 15644-108 | 16 | 4.0 | IEC C20 | 1 x 16A | (20) CH GB1002 10A, (4) 16A | 61.3 (1557) | 2.5 (64) | 1.8 (46) |
| 15644-112 | 16 | 4.0 | IEC 16A 1P+N+E | 1 x 16A | (20) C13, (4) C19 | 61.3 (1557) | 2.5 (64) | 1.8 (46) |
| 15644-115 | 16 | 4.0 | IEC 16A 1P+N+E | 1 x 16A | (24) Schuko DIN49440 16A | 61.0 (1549) | 1.8 (46) | 2.7 (69) |
| 15644-117 | 16 | 4.0 | IEC 16A 1P+N+E | 1 x 16A | (24) Universal GB2009.3 10A | 61.3 (1557) | 2.5 (64) | 1.8 (46) |
| 15644-118 | 16 | 4.0 | IEC 16A 1P+N+E | 1 x 16A | (20) CH GB1002 10A, (4) 16A | 61.3 (1557) | 2.5 (64) | 1.8 (46) |
| 15644-122 | 32 | 8.0 | IEC 32A 1P+N+E | 2 x 16A | (20) C13, (4) C19 | 66.5 (1689) | 2.5 (64) | 1.8 (46) |
| 15644-125 | 32 | 8.0 | IEC 32A 1P+N+E | 2 x 16A | (24) Schuko DIN49440 16A | 64.8 (1646) | 1.8 (46) | 2.7 (69) |
| 15644-127 | 32 | 8.0 | IEC 32A 1P+N+E | 2 x 16A | (24) Universal GB2009.3 10A | 66.5 (1689) | 2.5 (64) | 1.8 (46) |
| 15644-128 | 32 | 8.0 | IEC 32A 1P+N+E | 2 x 16A | (20) CH GB1002 10A, (4) 16A | 66.5 (1689) | 2.5 (64) | 1.8 (46) |
| 15644-132 | 13 | 3.3 | UK BS1363 | 1 x 13A | (20) C13, (4) C19 | 61.3 (1557) | 2.5 (64) | 1.8 (46) |
| 15644-137 | 13 | 3.3 | UK BS1363 | 1 x 13A | (24) Universal GB2009.3 10A | 61.3 (1557) | 2.5 (64) | 1.8 (46) |

Notes: All power strips have attached 10L (3 m) power cord. *kW values are at a Nominal voltage of 250V.

Metered Power Strips, Vertical Mount

| Part Number | Input | | | Output | | Dims - in (mm) | | |
|---|-------|-----|----------------|----------|-----------------------------|----------------|----------|----------|
| | Amp | kW* | Plug | Breakers | Outlets | H | W | D |
| 220-250 Volt, Single-Phase Power Strip | | | | | | | | |
| 15643-202 | 16 | 4.0 | IEC C20 | 1 x 16A | (10) C13, (4) C19 | 43.1 (1095) | 2.5 (64) | 1.8 (46) |
| 15643-206 | 16 | 4.0 | IEC C20 | 1 x 16A | (12) UK BS1363 13A | 48.3 (1227) | 2.5 (64) | 1.8 (46) |
| 15643-212 | 16 | 4.0 | IEC 16A 1P+N+E | 1 x 16A | (10) C13, (4) C19 | 43.1 (1095) | 2.5 (64) | 1.8 (46) |
| 15643-216 | 16 | 4.0 | IEC 16A 1P+N+E | 1 x 16A | (12) UK BS1363 13A | 48.3 (1227) | 2.5 (64) | 1.8 (46) |
| 15643-222 | 32 | 8.0 | IEC 32A 1P+N+E | 2 x 16A | (10) C13, (4) C19 | 48.3 (1227) | 2.5 (64) | 1.8 (46) |
| 15643-226 | 32 | 8.0 | IEC 32A 1P+N+E | 2 x 16A | (12) UK BS1363 13A | 53.4 (1357) | 2.5 (64) | 1.8 (46) |
| 15643-232 | 13 | 3.3 | UK BS1363 | 1 x 13A | (10) C13, (4) C19 | 43.1 (1095) | 2.5 (64) | 1.8 (46) |
| 15643-236 | 13 | 3.3 | UK BS1363 | 1 x 13A | (12) UK BS1363 13A | 48.3 (1227) | 2.5 (64) | 1.8 (46) |
| 15645-202 | 16 | 4.0 | IEC C20 | 1 x 16A | (20) C13, (4) C19 | 61.3 (1557) | 2.5 (64) | 1.8 (46) |
| 15645-205 | 16 | 4.0 | IEC C20 | 1 x 16A | (24) Schuko DIN49440 16A | 61.0 (1549) | 1.8 (46) | 2.7 (69) |
| 15645-207 | 16 | 4.0 | IEC C20 | 1 x 16A | (24) Universal GB2009.3 10A | 61.3 (1557) | 2.5 (64) | 1.8 (46) |
| 15645-208 | 16 | 4.0 | IEC C20 | 1 x 16A | (20) CH GB1002 10A, (4) 16A | 61.3 (1557) | 2.5 (64) | 1.8 (46) |
| 15645-212 | 16 | 4.0 | IEC 16A 1P+N+E | 1 x 16A | (20) C13, (4) C19 | 61.3 (1557) | 2.5 (64) | 1.8 (46) |
| 15645-215 | 16 | 4.0 | IEC 16A 1P+N+E | 1 x 16A | (24) Schuko DIN49440 16A | 61.0 (1549) | 1.8 (46) | 2.7 (69) |
| 15645-217 | 16 | 4.0 | IEC 16A 1P+N+E | 1 x 16A | (24) Universal GB2009.3 10A | 61.3 (1557) | 2.5 (64) | 1.8 (46) |
| 15645-218 | 16 | 4.0 | IEC 16A 1P+N+E | 1 x 16A | (20) CH GB1002 10A, (4) 16A | 61.3 (1557) | 2.5 (64) | 1.8 (46) |
| 15645-222 | 32 | 8.0 | IEC 32A 1P+N+E | 2 x 16A | (20) C13, (4) C19 | 66.5 (1689) | 2.5 (64) | 1.8 (46) |
| 15645-225 | 32 | 8.0 | IEC 32A 1P+N+E | 2 x 16A | (24) Schuko DIN49440 16A | 64.8 (1646) | 1.8 (46) | 2.7 (69) |
| 15645-227 | 32 | 8.0 | IEC 32A 1P+N+E | 2 x 16A | (24) Universal GB2009.3 10A | 66.5 (1689) | 2.5 (64) | 1.8 (46) |
| 15645-228 | 32 | 8.0 | IEC 32A 1P+N+E | 2 x 16A | (20) CH GB1002 10A, (4) 16A | 66.5 (1689) | 2.5 (64) | 1.8 (46) |
| 15645-232 | 13 | 3.3 | UK BS1363 | 1 x 13A | (20) C13, (4) C19 | 61.3 (1557) | 2.5 (64) | 1.8 (46) |
| 15645-237 | 13 | 3.3 | UK BS1363 | 1 x 13A | (24) Universal GB2009.3 10A | 61.3 (1557) | 2.5 (64) | 1.8 (46) |

*kW values are at a Nominal voltage of 250V.

Metered Power Strips, Vertical Mount

| Part Number | Input | | | Breakers | Output Outlets | Dims - in (mm) | | |
|--|-------|-----|----------------|----------|-----------------------------|----------------|----------|----------|
| | Amp | kW* | Plug | | | H | W | D |
| 220-250 Volt, Single-Phase Power Strip, Surge-Protected | | | | | | | | |
| 15643-102 | 16 | 4.0 | IEC C20 | 1 x 16A | (10) C13, (4) C19 | 43.1 (1095) | 2.5 (64) | 1.8 (46) |
| 15643-106 | 16 | 4.0 | IEC C20 | 1 x 16A | (12) UK BS1363 13A | 48.3 (1227) | 2.5 (64) | 1.8 (46) |
| 15643-112 | 16 | 4.0 | IEC 16A 1P+N+E | 1 x 16A | (10) C13, (4) C19 | 43.1 (1095) | 2.5 (64) | 1.8 (46) |
| 15643-116 | 16 | 4.0 | IEC 16A 1P+N+E | 1 x 16A | (12) UK BS1363 13A | 48.3 (1227) | 2.5 (64) | 1.8 (46) |
| 15643-122 | 32 | 8.0 | IEC 32A 1P+N+E | 2 x 16A | (10) C13, (4) C19 | 48.3 (1227) | 2.5 (64) | 1.8 (46) |
| 15643-126 | 32 | 8.0 | IEC 32A 1P+N+E | 2 x 16A | (12) UK BS1363 13A | 53.4 (1357) | 2.5 (64) | 1.8 (46) |
| 15643-132 | 13 | 3.3 | UK BS1363 | 1 x 13A | (10) C13, (4) C19 | 43.1 (1095) | 2.5 (64) | 1.8 (46) |
| 15643-136 | 13 | 3.3 | UK BS1363 | 1 x 13A | (12) UK BS1363 13A | 48.3 (1227) | 2.5 (64) | 1.8 (46) |
| 15645-102 | 16 | 4.0 | IEC C20 | 1 x 16A | (20) C13, (4) C19 | 61.3 (1557) | 2.5 (64) | 1.8 (46) |
| 15645-105 | 16 | 4.0 | IEC C20 | 1 x 16A | (24) Schuko DIN49440 16A | 61.0 (1549) | 1.8 (46) | 2.7 (69) |
| 15645-107 | 16 | 4.0 | IEC C20 | 1 x 16A | (24) Universal GB2009.3 10A | 61.3 (1557) | 2.5 (64) | 1.8 (46) |
| 15645-108 | 16 | 4.0 | IEC C20 | 1 x 16A | (20) CH GB1002 10A, (4) 16A | 61.3 (1557) | 2.5 (64) | 1.8 (46) |
| 15645-112 | 16 | 4.0 | IEC 16A 1P+N+E | 1 x 16A | (20) C13, (4) C19 | 61.3 (1557) | 2.5 (64) | 1.8 (46) |
| 15645-115 | 16 | 4.0 | IEC 16A 1P+N+E | 1 x 16A | (24) Schuko DIN49440 16A | 61.0 (1549) | 1.8 (46) | 2.7 (69) |
| 15645-117 | 16 | 4.0 | IEC 16A 1P+N+E | 1 x 16A | (24) Universal GB2009.3 10A | 61.3 (1557) | 2.5 (64) | 1.8 (46) |
| 15645-118 | 16 | 4.0 | IEC 16A 1P+N+E | 1 x 16A | (20) CH GB1002 10A, (4) 16A | 61.3 (1557) | 2.5 (64) | 1.8 (46) |
| 15645-122 | 32 | 8.0 | IEC 32A 1P+N+E | 2 x 16A | (20) C13, (4) C19 | 66.5 (1689) | 2.5 (64) | 1.8 (46) |
| 15645-125 | 32 | 8.0 | IEC 32A 1P+N+E | 2 x 16A | (24) Schuko DIN49440 16A | 64.8 (1646) | 1.8 (46) | 2.7 (69) |
| 15645-127 | 32 | 8.0 | IEC 32A 1P+N+E | 2 x 16A | (24) Universal GB2009.3 10A | 66.5 (1689) | 2.5 (64) | 1.8 (46) |
| 15645-128 | 32 | 8.0 | IEC 32A 1P+N+E | 2 x 16A | (20) CH GB1002 10A, (4) 16A | 66.5 (1689) | 2.5 (64) | 1.8 (46) |
| 15645-132 | 13 | 3.3 | UK BS1363 | 1 x 13A | (20) C13, (4) C19 | 61.3 (1557) | 2.5 (64) | 1.8 (46) |
| 15645-137 | 13 | 3.3 | UK BS1363 | 1 x 13A | (24) Universal GB2009.3 10A | 61.3 (1557) | 2.5 (64) | 1.8 (46) |

Notes: All power strips have attached 10'L (3 m) power cord. *kW values are at a Nominal voltage of 250V.



The Power Selector enables you to select the best power product for your application by narrowing down options based on your requirements. After you're done comparing, you can email or print the results. Visit selectapdu.com to access the Power Selector.

Basic Power Strips, Horizontal Rack-Mount

| Part Number | Input | | | Output | | Dims - in (mm) | | |
|---|-------|-----|----------------|-----------------------|----------------------------|----------------|------------|-----------|
| | Amp | kW* | Plug | Control | Outlets | H | W | D |
| 220-250 Volt, Single-Phase Power Strip | | | | | | | | |
| 15640-201 | 16 | 4.0 | IEC C20 | Master Lighted Switch | (10) C13 | 1U | 19"EIA/23" | 1.8 (46) |
| 15640-202 | 16 | 4.0 | IEC C20 | Master Lighted Switch | (6) C13, (4) C19 | 1U | 19"EIA/23" | 4.6 (117) |
| 15640-203 | 16 | 4.0 | IEC C20 | Master Lighted Switch | (4) C19 | 1U | 19"EIA/23" | 1.8 (46) |
| 15640-204 | 16 | 4.0 | IEC C20 | Master Lighted Switch | (6) CH GB1002 10A | 1U | 19"EIA/23" | 1.8 (46) |
| 15640-205 | 16 | 4.0 | IEC C20 | Master Lighted Switch | (6) Schuko DIN49440 16A | 1U | 19"EIA/23" | 1.8 (46) |
| 15640-206 | 16 | 4.0 | IEC C20 | Master Lighted Switch | (6) UK BS1363 13A | 1U | 19"EIA/23" | 1.8 (46) |
| 15640-207 | 16 | 4.0 | IEC C20 | Master Lighted Switch | (6) Universal GB2009.3 10A | 1U | 19"EIA/23" | 1.8 (46) |
| 15640-211 | 16 | 4.0 | IEC 16A 1P+N+E | Master Lighted Switch | (10) C13 | 1U | 19"EIA/23" | 1.8 (46) |
| 15640-212 | 16 | 4.0 | IEC 16A 1P+N+E | Master Lighted Switch | (6) C13, (4) C19 | 1U | 19"EIA/23" | 4.6 (117) |
| 15640-213 | 16 | 4.0 | IEC 16A 1P+N+E | Master Lighted Switch | (4) C19 | 1U | 19"EIA/23" | 1.8 (46) |
| 15640-214 | 16 | 4.0 | IEC 16A 1P+N+E | Master Lighted Switch | (6) CH GB1002 10A | 1U | 19"EIA/23" | 1.8 (46) |
| 15640-215 | 16 | 4.0 | IEC 16A 1P+N+E | Master Lighted Switch | (6) Schuko DIN49440 16A | 1U | 19"EIA/23" | 1.8 (46) |
| 15640-216 | 16 | 4.0 | IEC 16A 1P+N+E | Master Lighted Switch | (6) UK BS1363 13A | 1U | 19"EIA/23" | 1.8 (46) |
| 15640-217 | 16 | 4.0 | IEC 16A 1P+N+E | Master Lighted Switch | (6) Universal GB2009.3 10A | 1U | 19"EIA/23" | 1.8 (46) |
| 15640-231 | 13 | 3.3 | UK BS1363 | Master Lighted Switch | (10) C13 | 1U | 19"EIA/23" | 1.8 (46) |
| 15640-232 | 13 | 3.3 | UK BS1363 | Master Lighted Switch | (6) C13, (4) C19 | 1U | 19"EIA/23" | 4.6 (117) |
| 15640-236 | 13 | 3.3 | UK BS1363 | Master Lighted Switch | (6) UK BS1363 13A | 1U | 19"EIA/23" | 1.8 (46) |

Notes: Includes 19"EIA and 23"W horizontal rack-mount brackets. All power strips have a lighted master switch (no breaker) and an attached 10'L (3 m) cord.

*kW values are at a Nominal voltage of 250V.

Additional PDU Accessories

| Part Number | Description | Shipping Weight lb (kg) |
|-------------|--|-------------------------|
| 17762-003 | Cord Retention Tethers, Pack of 50 | 1 (0.5) |
| 17762-002 | Ground Wire Kit | 1 (0.5) |
| 17762-001 | Tool-less Mounting Hardware Kit, Pack of 2 | 1 (0.5) |
| 38645-700 | Standard PDU Bracket for ZetaFrame Cabinet | 2 (0.9) |
| 39110-C01 | Mounting Bracket Kit for F-Series TeraFrame Gen 3 Cabinet System or GF-Series GlobalFrame Gen 2 Cabinet System | 2 (0.9) |
| 13780-C01 | Mounting Bracket Kit for F-Series TeraFrame Gen 2 Cabinet System | 2 (0.9) |
| 25140-701 | Mounting Bracket Kit for GF-Series GlobalFrame Gen 1 Cabinet System | 2 (0.9) |
| 13762-701 | Mounting Bracket Kit for M-Series MegaFrame Cabinet System or C-Series SlimFrame Cabinet System | 2 (0.9) |
| 35700-701 | Mounting Bracket for Rack Systems | 2 (0.9) |

Note: Mounting Brackets are included with CPI Cabinets. Brackets for Cabinet Systems support two 2.2"W (56 mm) PDUs side-by-side or one 2.7"W (69 mm) PDU.

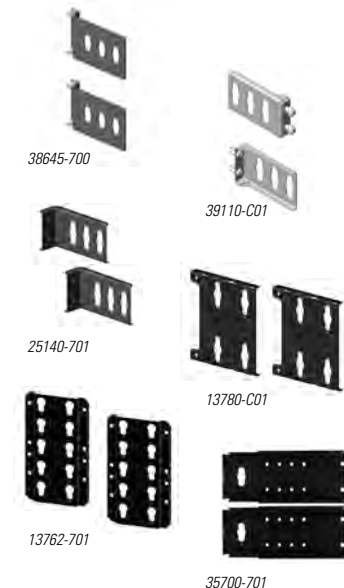



17763-007 shown.



17763-010 shown.



17763-013 shown.

IEC C20 PDU Input Power Cords

Input power cords for use with PDUs and Power Strips that have IEC C20 inlets.

- Select power cord to match power connection in the facility
- IEC C19 Connector attaches to the C20 Inlet on the PDU
- Sold individually, order (1) power cord per PDU

| Part Number | Description | Shipping Weight lb (kg) |
|-------------|--|-------------------------|
| 17763-001 | PDU Input Power Cord, 110-125 VAC or 200-240 VAC, IEC C19 Connector to IEC C20 Plug, 10'L (3 m) | 3 (1.4) |
| 17763-002 | PDU Input Power Cord, 110-125 VAC, IEC C19 Connector to NEMA 5-15P Plug, 8'2"L (2.4 m) | 3 (1.4) |
| 17763-003 | PDU Input Power Cord, 110-125 VAC, IEC C19 Connector to NEMA 5-20P Plug, 8'2"L (2.4 m) | 3 (1.4) |
| 17763-004 | PDU Input Power Cord, 200-240 VAC, IEC C19 Connector to NEMA 6-15P Plug, 8'2"L (2.4 m) | 3 (1.4) |
| 17763-005 | PDU Input Power Cord, 200-240 VAC, IEC C19 Connector to NEMA 6-20P Plug, 8'2"L (2.4 m) | 3 (1.4) |
| 17763-006 | PDU Input Power Cord, 110-125 VAC, IEC C19 Connector to NEMA L5-15P Plug, 10'L (3 m) | 3 (1.4) |
| 17763-007 | PDU Input Power Cord, 110-125 VAC, IEC C19 Connector to NEMA L5-20P Plug, 10'L (3 m) | 3 (1.4) |
| 17763-008 | PDU Input Power Cord, 200-240 VAC, IEC C19 Connector to NEMA L6-15P Plug, 10'L (3 m) | 3 (1.4) |
| 17763-010 | PDU Input Power Cord, 200-240 VAC, IEC C19 Connector to IEC 16A 1P+N+E Plug, 10'L (3 m) | 3 (1.4) |
| 17763-011 | PDU Input Power Cord, 200-240 VAC, IEC C19 Connector to 16A CEE7/7 Schuko Plug (Europe), 8'2"L (2.4 m) | 3 (1.4) |
| 17763-012 | PDU Input Power Cord, 200-240 VAC, IEC C19 Connector to BS1363 Plug (Britains), 8'2"L (2.4 m) | 3 (1.4) |
| 17763-013 | PDU Input Power Cord, 200-240 VAC, IEC C19 Connector to CEI23 Plug (Italian), 8'2"L (2.4 m) | 3 (1.4) |



Simplify ordering, shipping and installation by requesting eConnect PDUs and eConnect RFID Electronic Lock Kit to be installed in CPI's ZetaFrame, GF-Series GlobalFrame or F-Series TeraFrame cabinets before they leave the factory. Request Redundancy Pack for easy identification of primary and secondary units.

Add power. Make it easy.



SECTION 8

RACK SYSTEMS

| | | | |
|-----------------------------------|------|-----------------------------|------|
| Universal Rack..... | 8-3 | Shelves for Racks | 8-18 |
| Standard Rack..... | 8-6 | Keyboard Trays..... | 8-24 |
| Adjustable Rail, 4-Post Rack..... | 8-8 | Installation Products | 8-26 |
| Adjustable, 4-Post Rack..... | 8-11 | Rack Accessories | 8-28 |
| Fixed, 4-Post Rack..... | 8-15 | | |

RACK SYSTEMS

Designed and built with a commitment to quality, CPI Rack Systems can be quickly adapted for your changing needs, and deliver the confidence of unsurpassed strength, stability and durability, while keeping equipment safe and secure.

Where Can I Learn More?

To learn more about CPI's Rack Systems, or to find additional part numbers not listed in this catalog, please visit our website, chatsworth.com

Related Tools:

Use these tools, under the Resources tab on chatsworth.com, to simplify your planning, selection, order and purchase of CPI Rack Systems.

- Visio Shapes
- CAD Blocks
- BIM Drawings
- Cable Fill
- MasterFormat Specs
- OSHPD Products

Your Notes Here:





Universal Rack

Features:

- High-strength, lightweight aluminum extrusion construction
- (2) top angles or top bars and heavy-duty assembly hardware for stronger rack to handle heavier loading
- 50 special #12-24 mounting screws with combination Phillips/Straight heads and pilot points to reduce cross threading and installation time
- Unique packaging inserts eliminate damage from components hitting together in the carton during shipping and handling; racks are packed unassembled in individual cartons
- Ease of assembly is enhanced through use of threaded channels; no hex nuts are required
- Universal 5/8" - 5/8" - 1/2" (15.9 mm - 15.9 mm - 12.7 mm) alternating hole pattern offers greater mounting flexibility, maximizes usable mounting space and is compatible with conventional width 1-1/4" - 1/2" (31.8 mm - 12.7 mm) alternating hole patterns
- Integrated masked bonding studs on the inside of the rack channel for quick attachment to the Telecommunications Bonding System
- Available in powder coat color finishes: Gray, Computer Beige, Black, Glacier White or grained aluminum finish (Clear)
- State-of-the-art manufacturing methods provide the best quality and fastest delivery in the industry
- EIA-310-E side channels have multiple mounting holes and (4) pem nuts for quick installation of cable management
- EIA Channels: C-Shaped, 1.265" x 3" (32.13 mm x 76 mm); .25" (6.4 mm) thick front/rear flanges; .17" (4.3 mm) thick web (pair)
- Base Angles: 3.5" x 6.0" x .375" (89 mm x 152 mm x 9.53 mm) thick (pair)
- Top Angles: 1.5" x 1.5" x .25" (38 mm x 38 mm x 6.4 mm) thick (pair)
- Top Angles, Flush Bolted: 1.5" x 2.0" x .25 (38 mm x 51 mm x 6.4 mm) thick
- Top Bars: 1.5" x .25" (38 mm x 6.4 mm) thick (pair)
- Panel Mounting Holes: #12-24 rolled threads in both flanges front and back
- Custom configurations and assemblies available by special order
- Assembly hardware is included
- Select models (P/N 48353-XXX, 48383-XXX) are UL Listed: File E140851; Category DUXR (US), DUXR7 (Canada) — Communications Circuit Accessory
- Weight capacity 1500 lb (680.4 kg) — weight must be evenly distributed, and rack must be properly secured to floor



Bonding Studs located directly on rack channel



U marks simplify equipment installation

Installation Hint: When mounting equipment, use #3 Phillips tip to assure maximum torque.

Channel Cross Section and Hole Pattern Standards

CPI offers EIA aluminum channel uprights on all Standard and Universal racks. All Standard and Universal racks are threaded to accept industry standard #12-24 mounting screws. Extra care is taken in that the threads are "rolled" rather than "cut" for greater strength and durability. The Universal Rack hole pattern is 5/8"-5/8"-1/2" (15.9 mm-15.9 mm-12.7 mm) and is compatible with wide 1 1/4"-1/2" (31.8 mm-12.7 mm) patterns, while offering greater flexibility.

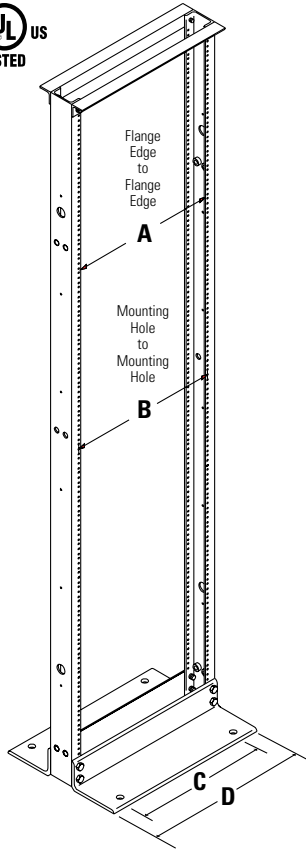

Universal Rack Ordering Matrix

- UL Listed racks offered in multiple heights and 19" or 23" widths
- For heavy-duty, high-capacity installations.

| Top Bar or Angles | |
|-------------------|---------------------------------|
| 460 | Two Top Bars |
| 463 | Two Top Angles |
| 467 | Two Top Angles, Flush Bolted |
| 483 | UL Listed (With Two Top Angles) |

| Width - in | |
|------------|----------------|
| 5 | 19 EIA Channel |
| 8 | 23 Channel |

| Mounting Holes | |
|----------------|---------------------------|
| 3 | Mounting Holes Both Sides |

| Color | |
|-------|----------------|
| 1 | Gray |
| 2 | Computer Beige |
| 5 | Clear |
| 7 | Black |
| E | Glacier White |

| Height | | |
|--------|-----------|-----|
| 31 | 3 (0.9) | 17U |
| 20 | 4 (1.2) | 24U |
| 19 | 5 (1.5) | 31U |
| 00 | 5.6 (1.7) | 34U |
| 01 | 6 (1.8) | 38U |
| 02 | 6.6 (2.0) | 41U |
| 03 | 7 (2.1) | 45U |
| 05 | 7.6 (2.3) | 48U |
| 15 | 8 (2.4) | 51U |
| 17 | 8.6 (2.6) | 55U |
| 08 | 9 (2.7) | 58U |

4XX X X - X XX

| Dimension | 19" EIA Rack in (mm) | 23" EIA Rack in (mm) |
|-----------|----------------------|----------------------|
| A | 17.75 (450.9) | 21.75 (552.5) |
| B | 18.31 (465.1) | 22.31 (566.7) |
| C | 16 (410.0) | 20 (510.0) |
| D | 20.31 (515.9) | 24.31 (617.5) |

| Shipping Weights - lb (kg) | |
|----------------------------|-----------|
| 6' (1.8 m) Rack | 37 (16.8) |
| 7' (2.1 m) Rack | 39 (17.7) |
| 8' (2.4 m) Rack | 41 (18.6) |

Top View of Base Angle

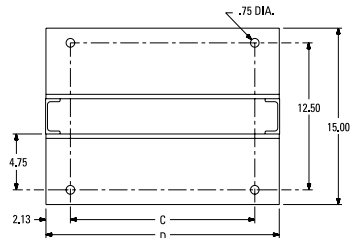

Dimensions:

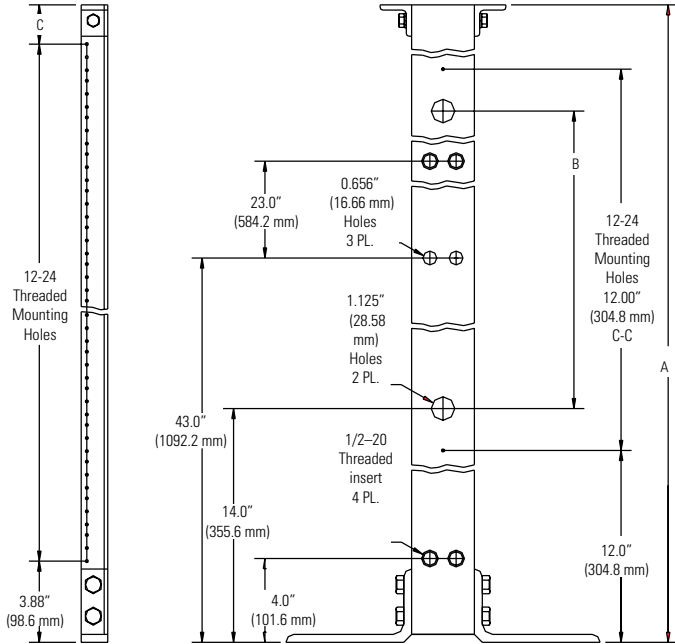

Front and Rear Flanges
(both sides drilled)

Web Surface
7' (2.1 m) Universal Rack

| Rack Height Dimension A ft (m) | Dimension B in (mm) | Dimension C in (mm) | Number of Mounting Holes | Number of Mounting Spaces |
|--------------------------------------|------------------------|------------------------|-----------------------------|------------------------------|
| 3 (0.9) | N/A | 1.75 (44.5) | 53 | 17 |
| 4 (1.2) | N/A | 2.13 (54.1) | 72 | 24 |
| 5 (1.5) | 43 (1090) | 1.88 (47.8) | 94 | 31 |
| 5.6 (1.7) | 44 (1120) | 2.00 (50.8) | 104 | 34 |
| 6 (1.8) | 56 (1420) | 2.12 (53.8) | 114 | 38 |
| 6.6 (2.0) | 56 (1420) | 1.75 (44.5) | 125 | 41 |
| 7 (2.1) | 56 (1420) | 1.87 (47.5) | 135 | 45 |
| 7.6 (2.3) | 56 (1420) | 2.62 (66.5) | 144 | 48 |
| 8 (2.4) | 72 (1830) | 2.25 (57.2) | 155 | 51 |
| 8.6 (2.6) | 72 (1830) | 2.38 (60.5) | 165 | 55 |
| 9 (2.7) | 72 (1830) | 2.00 (50.8) | 176 | 58 |

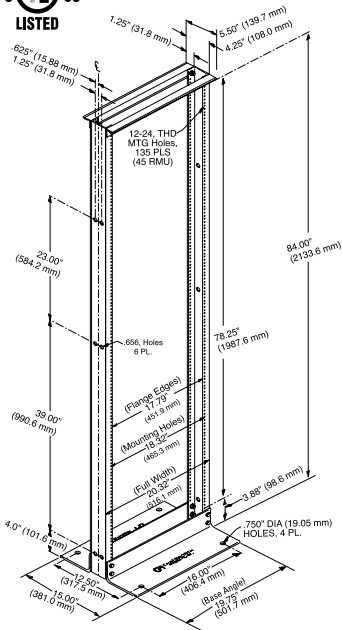

Standard Rack 3" D (80 mm)

The Standard Rack is designed for value conscious, high-volume customers, who require the quality and service that sets CPI racks apart from the competition. The Standard Rack is a UL Listed communication circuit accessory, designed specifically for use in telecommunications equipment installations where codes require UL Listed equipment racks. For a greater breadth of features, we recommend CPI Universal Racks.

- High-strength aluminum construction
- Shipped with (2) top angles, (2) base angles, (2) 3" D (80 mm) equipment channels and installation hardware
- Top angles allow J-bolt attachment without interfering with top U
- EIA-310-E Standard Universal 5/8" - 5/8" - 1/2" (15.9 mm - 15.9 mm - 12.7 mm) alternating hole pattern offers greater mounting flexibility and is fully compatible with conventional wide 1-1/4" - 1/2" (31.8 mm - 12.7 mm) alternating hole patterns
- (6) web channel holes per side enable multiple racks to be mounted together side by side or attachment of cable managers
- Integrated masked bonding studs on the inside of the rack channel for quick attachment to the Telecommunications Bonding System
- High-strength roll-formed threaded mounting holes
- Rack space U marks simplify equipment installation
- Includes 50 pilot point #12-24 mounting screws with combination Phillips/Straight heads to reduce cross-threading and installation time
- Available in powder coat color finishes: Gray, Computer Beige, Black, Glacier White or grained aluminum finish (Clear)
- Ships unassembled, individually packaged, with assembly hardware and installation instructions; bulk packaging is also available
- Redesigned shipping container saves space and freight costs
- Choose from (3) heights
- Weight capacity of 1000 lb (453.6 kg) — weight must be evenly distributed, and rack must be properly secured to the floor
- UL Listed; File E140851; Category DUXR (US), DUXR7 (Canada) – Communications Circuit Accessory

| Part Number | Description H x W Height - ft (m) | Shipping Weight lb (kg) |
|-------------|---|----------------------------|
| 55053-X03 | 7 (2.1) x 19", 45U | 31 (14.1) |
| 55053-X15 | 8 (2.4) x 19", 52U | 37 (16.8) |
| 55053-X08 | 9 (2.7) x 19", 58U | 40 (18.1) |

X=Color: 1=Gray, 2=Computer Beige, 5=Clear, 7=Black, E=Glacier White



Bonding Studs located directly on rack channel



U marks simplify equipment installation

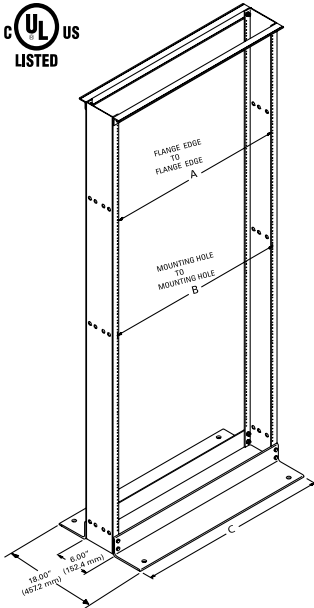

P/N 66363 (35" W) Shown:
The 6"D (150 mm) Standard Rack is the high-capacity frame that is designed for use with cabling sections and is the basic frame around which the XLBET/MDF frames are developed.

Standard Rack 6"D (150 mm)

Features 6"D (150 mm) upright mounting channels for MDF, IDF and other high-capacity distribution frame applications. The additional rack depth provides extra room for high-density equipment and cable needs.

- High-strength aluminum construction
- Supplied with (2) top angles for additional strength
- EIA-310-E Standard Universal 5/8" - 5/8" - 1/2" (15.9 mm - 15.9 mm - 12.7 mm) alternating hole pattern offers greater mounting flexibility and is fully compatible with conventional wide 1-1/4" - 1/2" (31.8 mm - 12.7 mm) alternating hole patterns
- Rack space U marks simplify equipment installation
- High-strength, roll-formed threaded mounting holes
- Ships unassembled and individually packaged
- Integrated masked bonding studs on the inside of the rack channel for quick attachment to the Telecommunications Bonding System
- Includes assembly hardware and (50) pilot point #12-24 mounting screws with combination Phillips/Straight heads
- Weight capacity 1000 lb (453.6 kg) — weight must be evenly distributed and rack must be properly secured to the floor
- UL Listed; File E140851; Category DUXR (US), DUXR7 (Canada) – Communications Circuit Accessory

| Part Number | Description H x W Height - ft (m) | Shipping Weight lb (kg) |
|-------------|---|----------------------------|
| 66353-X03 | 7 (2.1) x 19", 45U | 38 (17.2) |
| 66383-X03 | 7 (2.1) x 23", 45U | 42 (19.1) |
| 66363-X03 | 7 (2.1) x 35", 45U | 52 (23.6) |

X=Color: 1=Gray, 2=Computer Beige, 5=Clear, 7=Black, E=Glacier White

Rack Dimensions

| Dimension | 19" EIA Rack in (mm) | 23" EIA Rack in (mm) | 35" EIA Rack in (mm) |
|-----------|-------------------------|-------------------------|-------------------------|
| A | 17.79 (451.9) | 21.79 (553.5) | 33.79 (858.3) |
| B | 18.31 (465.1) | 22.31 (566.7) | 34.31 (871.5) |
| C | 20.31 (515.9) | 24.31 (617.5) | 36.31 (922.3) |



Adjustable Rail QuadraRack (ARQR) and Adjustable Rail ServerRack (ARSR)

The Adjustable Rail QuadraRack® (ARQR) and the Adjustable Rail ServerRack (ARSR) provide a sturdy, feature-rich solution for supporting rack-mount network, computer server and data storage equipment in data centers, computer equipment rooms and other IT facilities. Both racks offer the strength and stability of an enclosure in an open four-post mounting system that provides easy access to equipment and cabling.

The front and rear frames are welded to speed up assembly and increase strength. Four brackets connect the front and rear corners of the frames. Front mounting rails attach to the front frame in a fixed position and align with the front of the rack or can be reversed for recessed mounting to maximize side-to-side airflow through network switches. Rear mounting rails are adjustable in depth and can extend beyond the rear of the frame. A second set of holes along the sides of the frame lets you add optional side-mounted equipment support rails and vertical power strips that are independent of the mounting rails and use no U. The bottom of the rack is punched for easy floor attachment.

Each rack includes a Top-Mount Cable Waterfall Tray with adjustable radius drops to allow easy side-to-side routing for patch cords. Use with any CPI cabling section (vertical cable manager) or Cable Guide Kits to organize cables along the sides of the rack. Attach CPI Cable Runway to the top of the rack with J-Bolts, a Cable Runway Elevation Kit or a Cable Runway Mounting Bracket to support overhead premise cables. A side panel is also available.

Features:

- Available in three heights and two depths
- Adjustable Rail QuadraRack (ARQR) has threaded mounting holes that speed up installation of patch panels, fiber enclosures and network switches.
- Adjustable Rail ServerRack (ARSR) has square-punched mounting rails that allow you to change mounting hardware (Clik-Nut® or cage nuts) to match specific computer server and data storage equipment mounting requirements
- Each U is marked and numbered
- Front pair of mounting rails may be mounted to allow U numbering to start at the top or bottom of the rack
- Rear mounting rail adjusts in depth
- UL Listed; File E227626; Category NWIN (US), NWIN7 (Canada) – Information Technology and Communications Equipment Cabinet, Enclosure and Rack
- Each rack will support up to 2200 lb (1000.0 kg) of equipment

Includes:

- (2) mounting frames
- (4) horizontal braces
- (2) front mounting rails
- (2) rear mounting rails
- (1) top-mount cable tray
- Assembly hardware: (1) Two Mounting Hole Bonding Terminal Block and Antioxidant Joint Compound
- ARSR includes (50) #12-24 cage nuts and screws
- ARQR includes (50) #12-24 screws



Mounting Rails can be flipped to change numbering from bottom-to-top or top-to-bottom

Adjustable Rail 4-Post Rack Ordering Matrix

- UL Listed racks offered in multiple heights and 19" or 23" widths
- For heavy-duty, high-capacity installations.

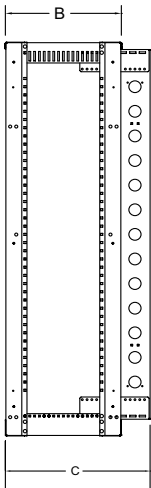
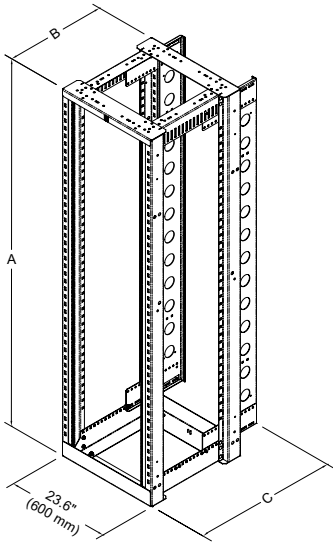

SIDE VIEW
MAX. RAIL DEPTH

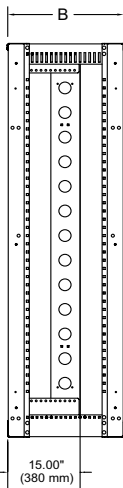

SIDE VIEW
MIN. RAIL DEPTH

| Adjustable Rail QuadraRack® and Adjustable Rail ServerRack | |
|--|----------------------------------|
| 1525 | 19" Adjustable Rail 4-Post Racks |

| | Mounting Hole Style | Rack Depth (B) in (mm) | Max. Rail Depth (C) in (mm) |
|---|---------------------|------------------------|-----------------------------|
| 1 | #12-24 Threaded | 23.62 (600) | 29.52 (750) |
| 2 | #12-24 Threaded | 35.43 (900) | 41.33 (1050) |
| 3 | Square-Punched | 23.62 (600) | 29.52 (750) |
| 4 | Square-Punched | 35.43 (900) | 41.33 (1050) |

Note: Min. Rail Depth is 15" (380 mm).

| Color | |
|-------|----------------|
| 1 | Gray |
| 2 | Computer Beige |
| 7 | Black |
| E | Glacier White |

| Height (A) | | |
|------------|----|------------------|
| | U | Height - in (mm) |
| 01 | 38 | 72 (1800) |
| 03 | 45 | 84 (2100) |
| 15 | 51 | 96 (2400) |

| | | | | |
|------|---|---|---|----|
| 1525 | X | - | X | XX |
|------|---|---|---|----|

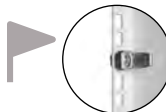

PATENTED

Clik-Nut® cage nuts make installation time quick and easy. Go to page 8-15 for ordering information.

Adjustable Rail 4-Post Rack Accessories

Equipment Support Rail

Attaches to the side of the Adjustable Rail QuadraRack or ServerRack and provides a .98"W (25 mm) support surface for equipment. Does not interfere with U spaces. Supports 200 lb (90.7 kg) of equipment and includes hardware.



15285-X01

Top-Mount Cable Waterfall Tray

One Top-Mount Cable Waterfall Tray is included with each rack to guide patch cords side-to-side or rack-to-rack. 6"W x 5.2"D (152 mm x 132 mm) steel tray.



15275-X01

Cable Guide Kit

T-shaped cable guides (7U) snap-on to the front or rear of the rack to organize cables. The openings align with each U space on the rack.

Side Panel

Solid, steel side panel used to cover the end of the rack and/or vertical cable managers at the end of a row. Matches the height and depth of rack, steel.



15286-001

Fixed Equipment Mounting Rail

Additional pair of equipment mounting rails to create a solution with two mounting desks set between 15"D (381 mm) and the rack depth. Includes installation hardware.



15270-X01



15260-X01

Mounting Rails can be flipped to change numbering from bottom-to-top or top-to-bottom

| Part Number | Description H x W Height - ft (m) | Shipping Weight lb (kg) |
|-------------|---|----------------------------|
| 15285-X01 | Equipment Rail, for 23.62" (600 mm) Racks | 7 (3.2) |
| 15285-X02 | Equipment Rail, for 35.43" (900 mm) Racks | 11 (5.0) |
| 15275-X01 | Top-Mount Cable Waterfall Tray | 14 (6.4) |
| 15286-X01 | Cable Guide, for 38U Racks, Black | 5 (2.3) |
| 15286-X03 | Cable Guide, for 45U Racks, Black | 6 (2.7) |
| 15286-X15 | Cable Guide, for 51U Racks, Black | 7 (3.2) |
| 15270-X01 | Side Panel, 23.62"D x 72"H | 51 (23.1) |
| 15270-X02 | Side Panel, 23.62"D x 84"H | 57 (25.9) |
| 15270-X03 | Side Panel, 23.62"D x 96"H | 48 (21.8) |
| 15270-X04 | Side Panel, 35.43"D x 72"H | 63 (28.6) |
| 15270-X05 | Side Panel, 35.43"D x 84"H | 71 (32.2) |
| 15270-X06 | Side Panel, 35.43"D x 96"H | 60 (27.2) |
| 15259-X01 | Fixed Rail, Threaded, for 38U Racks | 20 (9.1) |
| 15259-X03 | Fixed Rail, Threaded, for 45U Racks | 23 (10.4) |
| 15259-X15 | Fixed Rail, Threaded, for 51U Racks | 26 (11.8) |
| 15260-X01 | Fixed Rail, Square-Punched, for 38U Racks | 19 (8.6) |
| 15260-X03 | Fixed Rail, Square-Punched, for 45U Racks | 22 (10.0) |
| 15260-X15 | Fixed Rail, Square-Punched, for 51U Racks | 25 (11.3) |

X=Color, 1=Gray, 2=Computer Beige, 7=Black, E=Glacier White



Adjustable QuadraRack (AQR) and ServerRack (ASR)

The Adjustable QuadraRack and the Adjustable ServerRack provide a sturdy, cost-effective solution for supporting rack-mount network, computer server and data storage equipment in data centers, computer equipment rooms and other IT facilities. Both racks offer the strength and stability of an enclosure in an open four-post frame that provides easy access to equipment and cabling.

Each rack will support up to 2000 lb (907.2 kg) of equipment. The corner posts are C-shaped equipment mounting channels that provide front and rear support for 19" W rack-mount equipment or shelves. The front and rear frames are welded to reduce assembly time. Four brackets connect the front and rear corners of the rack. The rack is available in four heights and four depth ranges. The front-to-rear depth of the mounting channels can be adjusted up to 5.91" (150 mm) in depth in .98" (25 mm) increments during assembly. The mounting channels are fixed in place once assembled to surround and protect equipment.

The Adjustable QuadraRack has threaded mounting holes that make installation time of patch panels, fiber enclosures and network switches shorter. Adjustable ServerRack has square-punched holes that let you change mounting hardware (Clik-Nuts or cage nuts) to match specific computer server and data storage equipment mounting requirements. Each U is marked on the channels, making it easy to locate and position equipment. A second set of holes along the sides of the channels lets you add optional side-mounted Equipment Support Rails that use no additional U.

Features:

- Open design for unrestricted airflow and easy access to equipment and cabling
- Self-squaring assembly with welded front and rear frames reduces assembly time
- Mounting channels adjust in depth to provide front and rear support for equipment
- Maximizes floor space with a minimal rack footprint
- Rack components are bonded together during assembly
- Includes a Two Mounting Hole Bonding Terminal Block for easy attachment to the Secondary Bonding Busbar (SBB)
- Choose square-punched or threaded equipment mounting holes
- U spaces are marked on the mounting channels
- Easy to bay together to create multi-rack configurations
- Use with any CPI Cabling Section to manage cables
- Support large equipment on heavy-duty shelves or on side-mounted Equipment Support Rails
- UL Listed; File E227626; Category NWIN (US), NWIN7 (Canada) – Information Technology and Communications Equipment Cabinet, Enclosure and Rack
- Supports 2000 lb (907.2 kg) of equipment



Self-squaring
assembly

Adjustable 4-Post Rack Ordering Matrix

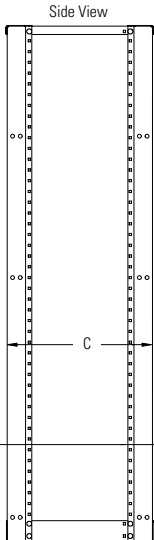
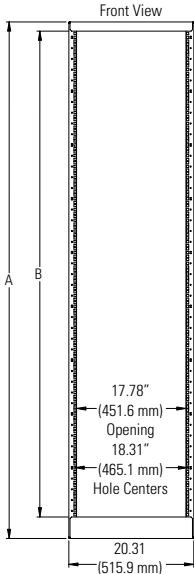

| Adjustable QuadraRack® and ServerRack, 19" | |
|--|-----------------------------|
| 1521 | 19" Adjustable 4-Post Racks |

| | Mounting Hole Style | Mounting Channel Depth Range (C) in (mm) |
|---|---------------------|--|
| 1 | Square-Punched | 15.75 to 21.65 (400 to 550) |
| 2 | Square-Punched | 22.64 to 28.54 (575 to 725) |
| 3 | Square-Punched | 29.53 to 35.43 (750 to 900) |
| 4 | Square-Punched | 36.42 to 42.32 (925 to 1075) |
| 5 | #12-24 Threaded | 15.75 to 21.65 (400 to 550) |
| 6 | #12-24 Threaded | 22.64 to 28.54 (575 to 725) |
| 7 | #12-24 Threaded | 29.53 to 35.43 (750 to 900) |
| 8 | #12-24 Threaded | 36.42 to 42.32 (925 to 1075) |

| Color | |
|-------|----------------|
| 1 | Gray |
| 2 | Computer Beige |
| 7 | Black |
| E | Glacier White |

| Height (A) | | | |
|------------|----|---------------|---------------|
| | U | (A) - in (mm) | (B) - in (mm) |
| 01 | 38 | 72 (1800) | 67 (1700) |
| 03 | 45 | 84 (2100) | 79 (2000) |
| 15 | 51 | 96 (2400) | 91 (2300) |
| 08 | 58 | 108 (2740) | 103 (2620) |

| | | | | |
|------|---|---|---|----|
| 1521 | X | - | X | XX |
|------|---|---|---|----|

Note: Mounting channel depth adjusts in .98" (25 mm) increments during assembly. The mounting depth is fixed once the rack is assembled. See the table on next page for a list of mounting channel depth settings by part number.

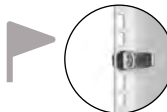
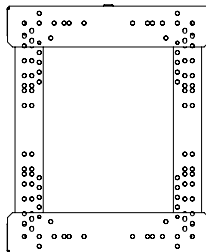

PATENTED

Click-Nut® cage nuts make installation time quick and easy. Go to page 8-15 for ordering information.

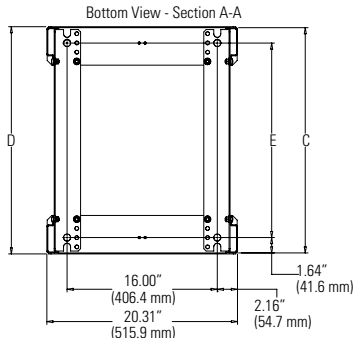

Notes:

1. There are seven depth settings for each part number as listed in the table.
2. Each rack adjusts front-to-rear in depth up to 5.91" (150 mm) in .98" (25 mm) increments.
3. Rack mounting channel depth is fixed once assembled.
4. Overall Depth (D) is Channel Depth (C) + .21" (5.3 mm).
5. Floor Mounting Holes (E) are Channel Depth (C) - 3.28" (83.3 mm).

| Mounting Channel Depth Settings and Dimensions by Part Number | | | | | | | |
|---|-----------|-------------------|------|-------------------|-------|--------------------------|-------|
| Part Numbers | | Channel Depth (C) | | Overall Depth (D) | | Floor Mounting Holes (E) | |
| | | in | mm | in | mm | in | mm |
| 15215-XXX | 15211-XXX | 15.75 | 400 | 15.96 | 405.4 | 12.47 | 316.7 |
| | | 16.73 | 425 | 16.94 | 430.3 | 13.45 | 341.6 |
| | | 17.72 | 450 | 17.93 | 455.4 | 14.44 | 366.8 |
| | | 18.70 | 475 | 18.91 | 480.3 | 15.42 | 391.7 |
| | | 19.69 | 500 | 19.90 | 505.5 | 16.41 | 416.8 |
| | | 20.67 | 525 | 20.88 | 530.4 | 17.39 | 441.7 |
| | | 21.65 | 550 | 21.86 | 555.2 | 18.37 | 466.6 |
| 15216-XXX | 15212-XXX | 22.64 | 575 | 22.85 | 580.4 | 19.36 | 491.7 |
| | | 23.62 | 600 | 23.83 | 605.3 | 20.34 | 516.6 |
| | | 24.61 | 625 | 24.82 | 630.4 | 21.33 | 541.8 |
| | | 25.59 | 650 | 25.80 | 655.3 | 22.31 | 566.7 |
| | | 26.57 | 675 | 26.78 | 680.2 | 23.29 | 591.6 |
| | | 27.56 | 700 | 27.77 | 705.4 | 24.28 | 616.7 |
| | | 28.54 | 725 | 28.75 | 730.3 | 25.26 | 641.6 |
| 15217-XXX | 15213-XXX | 29.53 | 750 | 29.74 | 755.4 | 26.25 | 666.8 |
| | | 30.51 | 775 | 30.72 | 780.3 | 27.23 | 691.6 |
| | | 31.50 | 800 | 31.71 | 805.4 | 28.22 | 716.8 |
| | | 32.48 | 825 | 32.69 | 830.3 | 29.2 | 741.7 |
| | | 33.46 | 850 | 33.67 | 855.2 | 30.18 | 766.6 |
| | | 34.45 | 875 | 34.66 | 880.4 | 31.17 | 791.7 |
| | | 35.43 | 900 | 35.64 | 905.3 | 32.15 | 816.6 |
| 15218-XXX | 15214-XXX | 36.42 | 925 | 36.63 | 930.4 | 33.14 | 841.8 |
| | | 37.40 | 950 | 37.61 | 955.3 | 34.12 | 866.6 |
| | | 38.39 | 975 | 38.60 | 980.4 | 35.11 | 891.8 |
| | | 39.37 | 1000 | 39.58 | 1005 | 36.09 | 916.7 |
| | | 40.35 | 1025 | 40.56 | 1030 | 37.07 | 941.6 |
| | | 41.34 | 1050 | 41.55 | 1055 | 38.06 | 966.7 |
| | | 42.32 | 1075 | 42.53 | 1080 | 39.04 | 991.6 |

Solid and Vented Shelves

1U x 19"W steel, shelf with adjustable depth rear mounting brackets; 17.68"W (449.1 mm). Supports 200 lb (90.7 kg) of equipment; includes assembly hardware.



| Part Number | Shelf Depth in (mm) | Mounting Channel Depth in (mm) | Shipping Weight lb (kg) |
|-----------------------|---------------------|--------------------------------|-------------------------|
| Solid Shelves | | | |
| 15245-X01 | 13.84 (351.5) | 15.75 to 21.65 (400 to 550) | 10 (4.5) |
| 15245-X02 | 20.73 (526.5) | 22.64 to 28.54 (575 to 725) | 12 (5.4) |
| 15245-X03 | 27.62 (701.6) | 29.53 to 35.43 (750 to 900) | 15 (6.8) |
| 15245-X04 | 34.51 (876.6) | 36.42 to 42.32 (925 to 1075) | 18 (8.2) |
| Vented Shelves | | | |
| 15255-X01 | 13.84 (351.5) | 15.75 to 21.65 (400 to 550) | 10 (4.5) |
| 15255-X02 | 20.73 (526.5) | 22.64 to 28.54 (575 to 725) | 12 (5.4) |
| 15255-X03 | 27.62 (701.6) | 29.53 to 35.43 (750 to 900) | 15 (6.8) |
| 15255-X04 | 34.51 (876.6) | 36.42 to 42.32 (925 to 1075) | 18 (8.2) |

X=Color; 1=Gray, 2=Computer Beige, 3=Black, 4=Glacier White



15235-X01



12700-X19



15205-X01



15330-X01



15335-X01

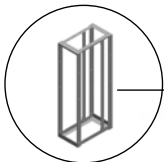

Adjustable 4-Post Rack Accessories

Equipment Support Rail

Additional support for heavy rack-mount equipment. Attaches to the side of rack and provides a 1.5"W (38 mm) front-to-rear support surface for equipment. Supports 200 lb (90.7 kg) of equipment; includes hardware.

Extra Heavy Duty Sliding Shelf

This 2U x 19"W sliding shelf with adjustable depth rear mounting brackets attaches to rack channels set 20.62"W to 32.48"D (525 to 825 mm). Solid surface is 15.5"W x 26"D (393.7 mm x 660 mm), extends 24" (609 mm) and locks in the open and closed positions. Supports 300 lb (136 kg) of equipment

Cable Runway Mounting Bracket

Aligns with the front, rear or side of the rack and supports 6"W to 24"W (150 mm to 600 mm) CPI Cable Runway. S-shaped, steel bracket measures 1.0"H x 3.3"W x 24.4"L (25 mm x 84 mm x 620 mm) and includes mounting hardware.

Center Rail

Attach the rails at any point along the side of the rack for adjustable depth. Marked and numbered U spaces simplify equipment installation. Maximum mount depth is 6" (152 mm) less than the channel depth of the rack. 1000 lb (453.6) equipment load bearing capacity when used as an independent pair or rails; rack load remains 2000 lb (907.2) when Center Rail is used as the front or rear pair of four-point mounting solution.

| Part Number | Description H x W Height - ft (m) | Shipping Weight lb (kg) |
|-------------|--|----------------------------|
| 15235-X01 | Equipment Rail, 15.75 to 19.69 (400 to 500) D | 5 (2.3) |
| 15235-X02 | Equipment Rail, 20.67 to 24.61 (525 to 625) D | 6 (2.7) |
| 15235-X03 | Equipment Rail, 25.59 to 29.53 (650 to 750) D | 7 (3.2) |
| 15235-X04 | Equipment Rail, 30.51 to 34.45 (775 to 875) D | 9 (4.1) |
| 15235-X05 | Equipment Rail, 35.43 to 39.37 (900 to 1000) D | 10 (4.5) |
| 15235-X06 | Equipment Rail, 40.35 to 44.29 (1025 to 1125) D | 12 (5.4) |
| 12700-X19 | Extra Heavy Duty Solid Shelf, 19"W | 51 (23.1) |
| 15205-X01 | Cable Runway Mounting Bracket, for 6 to 24 (150 to 600) W Cable Runway | 5 (2.3) |
| 15330-X01 | Center Rail, Square Punched, 38U, 72 (1800) H | 20 (9.1) |
| 15330-X03 | Center Rail, Square Punched, 45U, 84 (2100) H | 23 (10.4) |
| 15330-X15 | Center Rail, Square Punched, 51U, 96 (2400) H | 26 (11.8) |
| 15330-X08 | Center Rail, Square Punched, 58U, 108 (2740) H | 29 (13.2) |
| 15335-X01 | Center Rail, Threaded #12-24, 38U, 72 (1800) H | 20 (9.1) |
| 15335-X03 | Center Rail, Threaded #12-24, 45U, 84 (2100) H | 23 (10.4) |
| 15335-X15 | Center Rail, Threaded #12-24, 51U, 96 (2400) H | 26 (11.8) |
| 15335-X08 | Center Rail, Threaded #12-24, 58U, 108 (2740) H | 29 (13.2) |

X=Color, 1=Gray, 2=Computer Beige, 7=Black, E=Glacier White



QuadraRack Server Frame

Designed specifically for rack-mount servers, the QuadraRack Server Frame offers the strength and stability of a cabinet, but in an open mounting system. Providing easy access for simplified installation and cabling, the QuadraRack Server Frame offers unrestricted airflow for improved cooling and heat dissipation. The unique, steel C-shaped channels with square holes and horizontal braces, were designed to provide optimal torsional strength. The horizontal braces are quick and easy to install with the supplied carriage bolts. Since rack-mount servers require various types of mounting screws, cage nuts provide the flexibility.

- 19" W EIA
- Manufactured from aluminum and steel
- Available in powder coat color finishes: Gray, Computer Beige, Black or Glacier White
- EIA-310-E Standard Universal 5/8" - 5/8" - 1/2" (15.9 mm - 15.9 mm - 12.7 mm) alternating hole pattern
- Square-punched mounting holes adapt with Clik-Nuts or cage nuts (listed below) to match equipment mounting requirements
- Top Extension Pan Set provides two 6" x 16" (150 mm x 410 mm) cable access ports
- Frame depth is 29" (740 mm) with overall depth of 41" (1040 mm) from edge-to-edge of base angles
- Load Rating: 1000 lb (453.6 kg) — weight must be evenly distributed, and rack must be properly secured to the floor

QuadraRack Server Frame Kit includes:

- (4) Rack Channels
- (2) Base Angles
- (2) Top Angles
- (1) Extension Pan Set
- (8) Plate Nuts and Assembly Hardware
- (2) Horizontal Braces

| Part Number | Description H x W x D Height - ft (m), Depth - in (mm) | Shipping Weight lb (kg) |
|-------------|--|----------------------------|
| 15053-X03 | 7 (2.1) x 19 x 29 (740), 45U | 77 (34.9) |

X=color; 1=Gray, 2=Computer Beige, 7=Black, E=Glacier White



Steel Channels with square holes adapt to server mounting screws



Clik-Nut Hardware Kit, featuring a squeeze-and-release design, is available for square-punched rail options.

Square-Punched Hardware Kits (sold separately)

| Part Number | Nominal Size | Package Of | Finish | Shipping Weight lb (kg) |
|-------------|--------------|------------|----------------|----------------------------|
| 12637-001 | M-6 | 25 | Gold Over Zinc | 1 (0.5) |
| 12638-001 | 10-32 | 25 | Zinc | 1 (0.5) |
| 12639-001 | 12-24 | 25 | Black | 1 (0.5) |

Clik-Nut Hardware Kit

| Part Number | Thread Size | Package Of | Shipping Weight lb (kg) |
|-------------|-------------|------------|----------------------------|
| 76543-X01 | M6 x 1.0 | 25 | 1 (0.5) |
| 76544-X01 | 12-24 | 25 | 1 (0.5) |
| 76545-X01 | 10-32 | 25 | 1 (0.5) |

X=color; 0=Zinc, 7=Black Zinc



Not intended for rack-mount servers

QuadraRack 4-Post Frame

The QuadraRack 4-Post Frame offers the strength and stability of a cabinet in an open mounting system. Enjoy easy equipment installation, along with unrestricted airflow for improved cooling and heat dissipation.

- 19" W EIA
- Manufactured from aluminum
- EIA-310-D Standard Universal 5/8" - 5/8" - 1/2" (15.9 mm - 15.9 mm - 12.7 mm) alternating hole pattern, mounting holes are roll-formed #12-24
- Ships unassembled
- Load Rating: 2000 lb (907.2 kg) — weight must be evenly distributed, and rack must be properly secured to the floor

QuadraRack 4-Post Frame Kit includes:

- (4) Rack Channels
- (2) Base Angles
- (2) Top Angles
- (1) Extension Pan Set
- (1) Bag of 100 Rack mounting screws — Pilot Point #12-24 with combination Phillips/Straight head

| Part Number | Description H x W x D Height - ft (m), Depth - in (mm) | Shipping Weight lb (kg) |
|-------------|--|----------------------------|
| 50120-X03 | 7 (2.1) x 19 x 29 (740), 45U | 65 (29.5) |
| 50120-X15 | 8 (2.4) x 19 x 29 (740), 51U | 67 (30.4) |
| 50120-X08 | 9 (2.7) x 19 x 29 (740), 58U | 69 (31.3) |

X=color: 1=Gray, 2=Computer Beige, 5=Clear, 7=Black, E=Glacier White

ExpandaRack

Convert a CPI two-post rack to a QuadraRack with ExpandaRack.

| Part Number | Description H x W x D Height - ft (m), Depth - in (mm) | Shipping Weight lb (kg) |
|--------------------------------------|--|----------------------------|
| ExpandaRack - Standard Rack | | |
| 50110-X03 | 7 (2.1) x 19 x 29 (740), 45U | 46 (20.9) |
| 50110-X15 | 8 (2.4) x 19 x 29 (740), 51U | 48 (21.8) |
| 50110-X08 | 9 (2.7) x 19 x 29 (740), 58U | 50 (22.7) |
| ExpandaRack - Universal Rack | | |
| 50130-X03 | 7 (2.1) x 19 x 29 (740), 45U | 52 (23.6) |
| 50130-X15 | 8 (2.4) x 19 x 29 (740), 51U | 55 (24.9) |
| 50130-X08 | 9 (2.7) x 19 x 29 (740), 58U | 58 (26.3) |
| ExpandaRack - Pan Set (W x D) | | |
| 50150-X99 | 19 x 29 (740) — Standard Rack | 18 (8.2) |
| 50160-X99 | 19 x 29 (740) — Universal Rack | 18 (8.2) |

X=color: 1=Gray, 2=Computer Beige, 5=Clear, 7=Black, E=Glacier White



1U



16351-X19

1U



16350-X19

2U

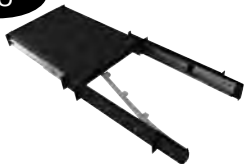

12700-X19

3U



16356-X19



16341-X19

QuadraRack Accessories

Heavy Duty Fixed Shelf - Solid

Specially designed for QuadraRack. 1U x 19"W x 29"D (740 mm) shelf. Supports up to 200 lb (90.7 kg).

Heavy Duty Fixed Shelf - Vented

Specially designed for QuadraRack. 1U x 19"W x 29"D (740 mm) vented shelf that optimizes airflow. Supports up to 200 lb (90.7 kg).

Extra Heavy Duty 4-Point Sliding Shelf

Specially designed to support heavy equipment. 2U x 19"W x 26"D (660 mm) sliding shelf, extends 24" (610 mm), adjusts between 20" and 34" (510 mm and 860 mm) mounting depth. Supports up to 300 lb (136.1 kg).

Equipment Tie-Down Bracket

Prevents back-and-forth, side-to-side and up-and-down movement of shelf-mount equipment. 3U x 19"W x 23"D (580 mm).

Dust Cover

Improves the appearance of QuadraRack 4-Post Frame and prevents the accumulation of dust and debris at the base.

Power Strips

Both horizontal and vertical power strips can be mounted to the QuadraRack. These solutions can be found in Section 7.

| Part Number | Description H x W Height - ft (m) | Shipping Weight lb (kg) |
|-------------|---|----------------------------|
| 16351-X19 | Heavy Duty Fixed Shelf, Solid | 11 (5.0) |
| 16350-X19 | Heavy Duty Fixed Shelf, Vented | 11 (5.0) |
| 12700-X19* | Extra Heavy Duty Sliding Shelf* | 8 (3.6) |
| 16342-X01 | Rack Line-Up Spacer, Universal | 1 (0.5) |
| 16342-X02 | Rack Line-Up Spacer, Standard | 1 (0.5) |
| 16356-X19 | Equipment Tie-Down Bracket | 4 (1.8) |
| 16341-X19 | Rack Base Dust Cover | 4 (1.8) |

X=Color: 1=Gray, 2=Computer Beige, 5=Clear, 7=Black, E=Glacier White

**Not available in Clear.*

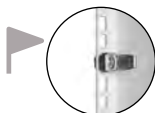

PATENTED

*Clik-Nut® cage nuts makes installation time quick and easy.
Go to page 8-15 for ordering information.*

2U

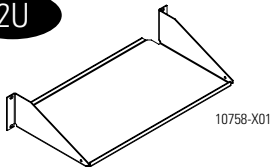

10758-X01

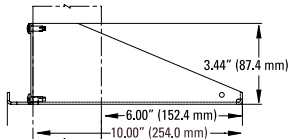

Shelves

Small Peripheral Shelf

Designed to hold small peripheral equipment in a central location. Each shelf typically holds two units and allows a convenient cable run down the inside of the rack channel. Mounting hardware not included. 19" rack mountable, holds equipment up to 17.35"W x 9.82"D (440.7 mm x 249.4 mm). Made of strong, lightweight aluminum; supports up to 50 lb (22.7 kg).

Single-Sided Shelf

A convenient 15"D (380 mm) mounting shelf for miscellaneous equipment, test gear, etc. Mounting hardware not included. 19" version holds equipment up to 17.25"W x 14.82"D (438.2 mm x 376.4 mm), 23" version holds equipment up to 21.25"W x 14.82"D (539.8 mm x 376.4 mm). Made of strong, lightweight aluminum; supports up to 50 lb (22.7 kg). 19" version is UL Listed: File E140851; Category DUXR (US), DUXR7 (Canada) – Communications Circuit Accessory.

3U

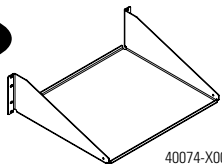

40074-X00

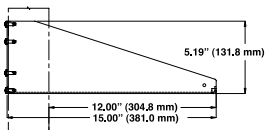

Single-Sided Vented Shelf

Supports routers, switches, CPUs or any equipment requiring bottom ventilation. Mounting hardware not included. 19" version holds equipment up to 17.25"W x 14.82"D (438.2 mm x 376.4 mm), 23" version holds equipment up to 21.25"W x 14.82"D (539.8 mm x 376.4 mm). Wall, backboard or rack mountable. Made of strong, lightweight aluminum with airflow perforations; supports up to 50 lb (22.7 kg).

16"D (410 mm) Low-Profile Shelf

Reduced height design saves on valuable rack space. Center mount design is ideal for single sided racks, mounts to either front or back of rack channel face. Mounting hardware not included. 19"W version holds equipment up to 17.25"W x 15.82"D (438.2 mm x 401.8 mm), 23"W version holds equipment up to 21.25"W x 15.82"D (539.8 mm x 401.8 mm). Made of strong, lightweight aluminum; supports up to 40 lb (18.1 kg).

3U

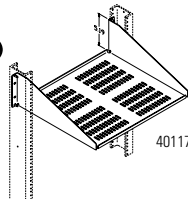

40117-X19

2U

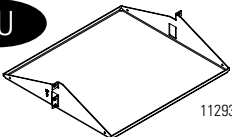

11293-X19

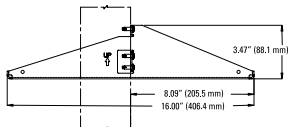

| Part Number | Description | Shipping Weight lb (kg) |
|-------------|---|-------------------------|
| 10758-X01 | Small Peripheral Shelf, 19"W | 5 (2.3) |
| 40074-X00 | Single-Sided Shelf, For 19" Rack | 6 (2.7) |
| 40075-X00 | Single-Sided Shelf, For 23" Rack | 7 (3.2) |
| 40117-X19 | Single-Sided Vented Shelf, For 19" Rack | 6 (2.7) |
| 40118-X23 | Single-Sided Vented Shelf, For 23" Rack | 7 (3.2) |
| 11293-X19 | Low-Profile Shelf, For 19" Rack | 4 (1.8) |
| 11293-X23 | Low-Profile Shelf, For 23" Rack | 5 (2.3) |

X=color: 1=Gray, 2=Computer Beige, 5=Clear, 7=Black, E=Glacier White

3U

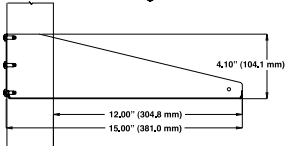
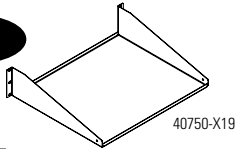

3U

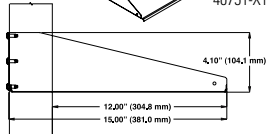
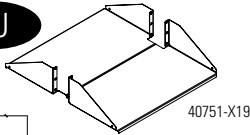

2U

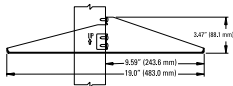
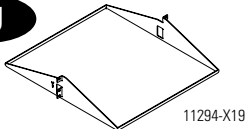

5U

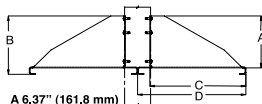
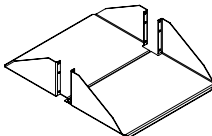

A 6.37" (161.8 mm)
 B 7.16" (181.9 mm)
 C 11.53" (292.9 mm)
 D 13.00" (330.2 mm)

Shelves

Standard Single-Sided Steel Shelf

Economical rack or wall-mounted shelf for miscellaneous equipment. Made of cold-rolled steel and may be rack or wall-mounted. 19" rack-mountable, holds equipment up to 17.25"W x 14.75"D (438.2 mm x 374.7 mm). Supports up to 35 lb (15.9 kg).

Standard Double-Sided Steel Shelf

An economical rack or wall-mounted shelf with twice the shelf space for centered loading and deeper equipment handling. Made of cold-rolled steel, this shelf mounts on double-sided racks only. 19"W rack-mountable, holds equipment up to 17.25"W x 21.50"D (438.2 mm x 546.1 mm) and supports up to 25 lb (11.3 kg) per side or 50 lb (22.7 kg) total.

19"D (480 mm) Low-Profile Shelf

Reduced height design saves on valuable rack space. Mounts to either front or back of rack channel face. Mounting hardware not included. 19" version holds equipment up to 17.25"W x 18.82"D (438.2 mm x 478.0 mm), 23" version holds equipment up to 21.25"W x 18.82"D (539.8 mm x 478.0 mm). Made of strong, lightweight aluminum; supports up to 40 lb (18.1 kg).

26"D (660 mm) Shelf

Extra deep design is convenient for mounting large equipment requiring additional support. Will fit inside most CPI rack enclosures, except P/N 11058 or wall enclosure). Mounting hardware not included. 19" version holds equipment up to 17.75"W x 25.8"D (450.9 mm x 655.8 mm), 23" version holds equipment up to 21.75"W x 25.8"D (552.5 mm x 655.8 mm). Made of strong, lightweight aluminum; supports up to 150 lb (68.0 kg). 19" version is UL Listed: File E140851; Category DUXR (US), DUXR7 (Canada) – Communications Circuit Accessory.

| Part Number | Description | Shipping Weight lb (kg) |
|-------------|-----------------------------------|-------------------------|
| 40750-X19* | Standard Single-Sided Steel Shelf | 12 (5.4) |
| 40751-X19* | Standard Double-Sided Steel Shelf | 10 (4.5) |
| 11294-X19 | Low Profile Shelf, For 19" Rack | 5 (2.3) |
| 11294-X23 | Low Profile Shelf, For 23" Rack | 6 (2.7) |
| 11054-X19 | 26"D (660 mm) Shelf, For 19" Rack | 10 (4.5) |
| 11054-X23 | 26"D (660 mm) Shelf, For 23" Rack | 10 (4.5) |

X=color: 1=Gray, 2=Computer Beige, 5=Clear, 7=Black, E=Glacier White

*Shelves are not available in clear finish.

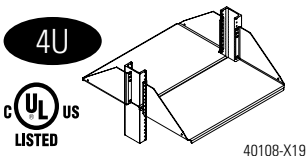

40108-X19

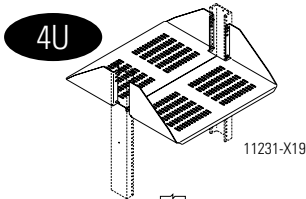
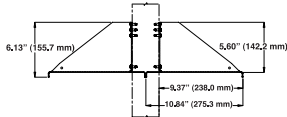

11231-X19

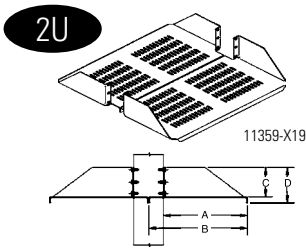
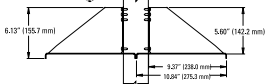

11359-X19

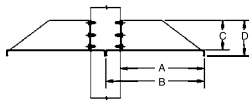

- A 8.53" (216.7 mm)
- B 10.0" (254.0 mm)
- C 2.91" (73.9 mm)
- D 3.53" (89.7 mm)

Shelves

Double-Sided Shelf

Provides centered loading for deeper and heavier equipment. Mounts on 3"D (80 mm) double-sided racks only. Mounting hardware not included. 19" version holds equipment up to 17.75"W x 21.5"D (450.9 mm x 546.0 mm), 23" version holds equipment up to 21.75"W x 21.5"D (552.5 mm x 546.0 mm). Made of strong, lightweight aluminum; supports up to 100 lb (45.4 kg). 19" version is UL Listed: File E140851; Category DUXR (US), DUXR7 (Canada) – Communications Circuit Accessory.

Double-Sided Vented Shelf

Convenient for mounting any equipment requiring bottom ventilation, airflow perforations for increased airflow around components. Mounting hardware not included. 19" version holds equipment up to 17.75"W x 21.5"D (450.9 mm x 546.0 mm). Made of strong, lightweight aluminum; supports up to 100 lb (45.4 kg).

Double-Sided Low-Profile Vented Shelf

Reduced height design saves valuable rack space and perforated shelf keeps equipment cool, includes bottom ventilation for enhanced airflow circulation. Mounting hardware not included. 19" version holds equipment up to 17.75"W x 19.8"D (450.9 mm x 503.4 mm). Mounts on 3"D (80 mm) double-sided racks only. Made of strong, lightweight aluminum; supports up to 60 lb (27.2 kg)

| Part Number | Description | Shipping Weight lb (kg) |
|-------------|--|-------------------------|
| 40108-X19 | Double-Side Shelf, For 19" Rack | 8 (3.6) |
| 40108-X23 | Double-Side Shelf, For 23" Rack | 9 (4.1) |
| 11231-X19 | Double-Side Vented Shelf, For 19" Rack | 8 (3.6) |
| 11359-X19 | Low-Profile Vented Shelf For 19" Rack | 8 (3.6) |
| 11359-X23 | Low-Profile Vented Shelf For 23" Rack | 9 (4.1) |

X=color: 1=Gray, 2=Computer Beige, 5=Clear, 7=Black, E=Glacier White

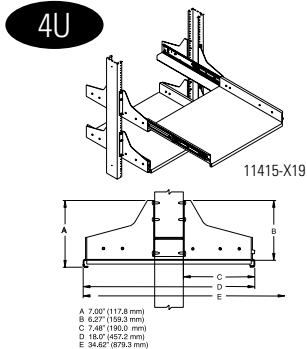
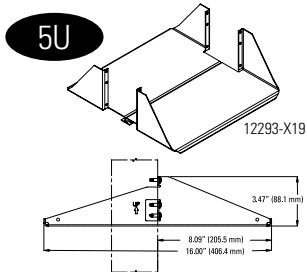
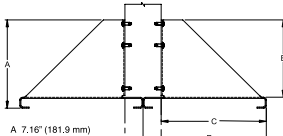
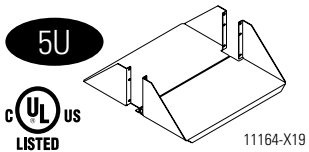

Shelves

Heavy Duty Equipment Shelf for 3" (80 mm) Channel

Convenient for mounting large equipment requiring additional support. Mounting hardware not included. 19" version holds equipment up to 17.75"W x 19.8"D (450.9 mm x 503.4 mm), 23" version holds equipment up to 21.75"W x 19.8"D (552.5 mm x 503.4 mm). Made of strong, lightweight aluminum; supports up to 200 lb (90.7 kg). 19" version is UL Listed: File E140851; Category DUXR (US), DUXR7 (Canada) – Communications Circuit Accessory.

Heavy Duty Equipment Shelf for 6" (150 mm) Channel

This shelf is designed to hold heavy equipment requiring extra support. Fits Standard Rack 6"D (150 mm) and SeismicFrame® Two Post Rack. Mounting hardware not included. 19" version holds equipment up to 17.75"W x 19.8"D (450.9 mm x 503.4 mm). Made of strong, lightweight aluminum; supports up to 200 lb (90.7 kg).

Sliding Equipment Shelf

Provides a sliding shelf for front access to all equipment. Mounting hardware not included. 18"D (460 mm) shelf extends out an additional 16" (410 mm) from closed position. Lockable in fully extended and fully retracted positions. 19" version holds up to 16"W x 17.5"D (410 mm x 445 mm) equipment, 23" version holds up to 20"W x 17.5"D (510 mm x 445 mm) equipment. Mounts on 3"D (80 mm) double-sided racks only. Made of sturdy, lightweight aluminum; supports up to 100 lb (45.4 kg).

| Part Number | Description | Shipping Weight lb (kg) |
|-------------|--|-------------------------|
| 11164-X19 | Heavy Duty Shelf for 3" (80 mm) Channel, For 19" Rack | 8 (3.6) |
| 11164-X23 | Heavy Duty Shelf for 3" (80 mm) Channel, For 23" Rack | 9 (4.1) |
| 12293-X19 | Heavy Duty Shelf for 6" (150 mm) Channel, For 19" Rack | 10 (4.5) |
| 11415-X19 | Sliding Equipment Shelf, For 19" Rack | 13 (5.9) |
| 11415-X23 | Sliding Equipment Shelf, For 23 Rack | 13 (5.9) |

X=color: 1=Gray, 2=Computer Beige, 5=Clear, 7=Black, E=Glacier White

anyServer Bracket

The anyServer Bracket is a simple, yet sturdy solution to secure virtually any server to a 19"W, two-post open rack. It is the ideal, cost-effective system for retrofitting existing racks to accommodate one or more servers, instead of reverting to a four-post rack or cabinet system. The anyServer Bracket can be adjusted to fit all of your server's requirements, enabling you to keep the same mounting system, even if you change equipment in the future.

Purchase optional Supplementary Server Support Arms to firmly secure the tops of tall servers to the rack. In some instances, they can also help you mount your server if its captive screw holes are in the middle or top of the device.

The anyServer Bracket comes with front and rear steel pans and four steel adjustable arms (with mounting hardware).

- Manufactured from cold rolled steel
- The server can be positioned 9" to 13" (230 mm to 330 mm) in front of the rack channel; mounting arms extend 4" (100 mm) total in .5" (10 mm) increments
- Square holes at the front of adjustable mounting arms for Klik-Nuts or cage nuts (sold separately)
- Acorn nuts eliminate sharp edges
- Supplementary arms (purchased separately) provide extra support
- Load rating:
 - 1U bracket is 80 lb (36.3 kg)
 - 2U bracket is 120 lb (54.4 kg)
- Rack mounting hardware is not included

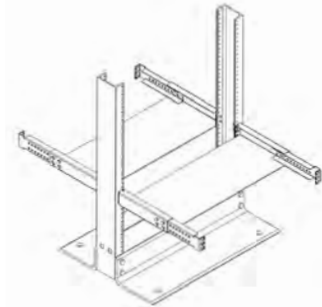

A split-pan design provides a broader surface area to support server weight

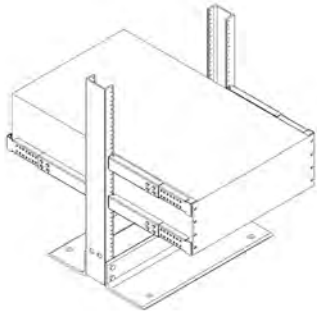

anyServer Bracket shown on rack with server and optional Server Support Arms

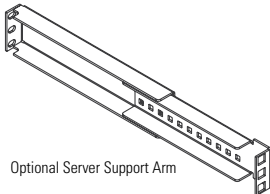

Optional Server Support Arm

| Part Number | Description | Shipping Weight lb (kg) |
|-------------|---|-------------------------|
| 12751-719 | 1U x 19, Black Bracket | 11 (5.0) |
| 12752-719 | 2U x 19, Black Bracket | 14 (6.4) |
| 12759-701 | Supplementary Server Support Arms, Fixed, 1 Pair, 1U, Black | 3 (1.4) |

| Square-Punched Hardware Kits (sold separately) | | | | |
|--|--------------|------------|----------------|-------------------------|
| Part Number | Nominal Size | Package Of | Finish | Shipping Weight lb (kg) |
| 12637-001 | M-6 | 25 | Gold Over Zinc | 1 (0.5) |
| 12638-001 | 10-32 | 25 | Zinc | 1 (0.5) |
| 12639-001 | 12-24 | 25 | Black | 1 (0.5) |

Lockable Storage Drawer

CPI's improved Lockable Storage Drawer keeps backup media, software, manuals, laptops, test equipment and extra patch cords in close proximity to where they are typically used within a rack or cabinet.



Drawer with two-post mounting brackets



Drawer with four-post mounting brackets

Lockable Storage Drawer is available for 19"W or 23"W racks and cabinets. It includes attachment brackets that allow center mounting on two-post racks with 3" or 6" D (80 mm or 150 mm) equipment channels, or front and rear attachment to four-post racks and cabinet systems with mounting rails that are adjusted between 24" and 39" D (610 mm and 990 mm).

- Attaches to any CPI free-standing 19"W or 23"W rack or cabinet system
- Available in three heights: 2U, 3U and 4U
- Features 20"D (510 mm) lockable drawer that extends full-depth for easy access to stored equipment
- Redesigned to allow for stackable units
- Supports a 100 lb (45.4 kg) load (drawer and top surface combined)

| Part Number | Description | Shipping Weight lb (kg) |
|--|---------------------|-------------------------|
| 19" Rack or Cabinet Mount - Depth - in (mm) | | |
| 13082-X19 | 2U Drawer, 20 (510) | 18 (8.2) |
| 13083-X19 | 3U Drawer, 20 (510) | 20 (9.1) |
| 13084-X19 | 4U Drawer, 20 (510) | 22 (10.0) |
| 23" Rack or Cabinet Mount - Depth - in (mm) | | |
| 13082-X23 | 2U Drawer, 20 (510) | 21 (9.5) |
| 13083-X23 | 3U Drawer, 20 (510) | 23 (10.4) |
| 13084-X23 | 4U Drawer, 20 (510) | 25 (11.3) |

*X=*color: 1=Gray, 2=Computer Beige, 5=Clear, 7=Black, E=Glacier White

1U

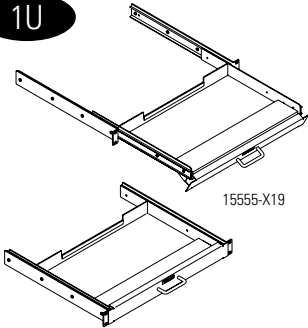

Flush Mounted Sliding Keyboard Tray with Wrist Rest

Space-saving tray requires only 1U (44.45 mm), providing more space for mounting electronics. Ball bearing slides for smooth operation. Locks in open position, and retracts when not in use. 19" version holds up to 16.37"W x 7.67"D (415.8 mm x 194.8 mm) keyboards, 23" version holds up to 20.37"W x 8.67"D (517.4 mm x 220.2 mm) keyboards. Mounting hardware not included. Keyboard tray extends 11" (280 mm) for full access to all keys. Made of strong, lightweight aluminum.

Flush Mounted Keyboard Tray

Provides retractable rack-mounting tray for most keyboards up to 8.5"D (216 mm). Mounting hardware not included. Extends 8" (200 mm), giving full access to keyboard. Retracts when not in use. 19" version holds up to 16.1"W (409 mm) keyboards. Made of strong, lightweight aluminum. This tray does not support the mouse pad attachment.

2U

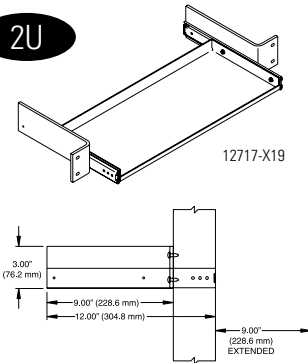

CPU/Monitor Shelf with Single Sliding Keyboard Tray

Provides convenient mounting of CPU or monitor and keyboard. Mounting hardware not included. Keyboard tray extends 8.6" (218 mm), 19"W rack trays must use small footprint keyboard; maximum width 16.30" (414 mm). 19" holds equipment up to 17.75"W x 19.82"D (450.9 mm x 503.4 mm), 23" holds equipment up to 21.75"W x 19.82"D (552.5 mm x 503.4 mm). Made of strong, lightweight aluminum; supports up to 200 lb (90.7 kg).

| Part Number | Description | Shipping Weight lb (kg) |
|-------------|---|-------------------------|
| 15555-X19 | Flush Mount Sliding Keyboard with Wrist Rest, For 19" Racks | 8.5 (3.9) |
| 15556-X23 | Flush Mount Sliding Keyboard with Wrist Rest, For 23" Racks | 10 (4.5) |
| 12717-X19* | Flush Mount Keyboard Tray, For 19" Racks | 8 (3.6) |
| 11487-X19 | Monitor Shelf, Single Tray, For 19" Rack | 12 (5.4) |
| 11487-X23 | Monitor Shelf, Single Tray, For 23" Rack | 12 (5.4) |

6U

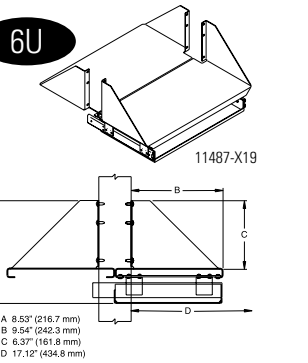

X=Color: 1=Gray, 2=Computer Beige, 5=Clear, 7=Black, E=Glacier White

*19" rack tray must use small footprint keyboard.

2U

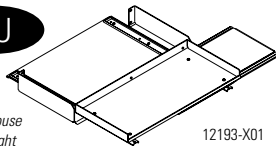

12193-X01

Note: Mouse pad on right side only

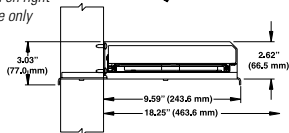

2U

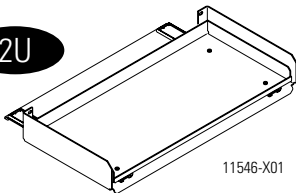

11546-X01

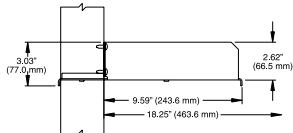

19" Full Size Sliding Keyboard & Mouse Tray

Holds full size keyboard and mouse. Slide is mounted under shelf to provide maximum tray width. Mounting hardware not included. Mouse pad tray is 10"W x 8"D (250 mm x 200 mm) and retracts out of the way when not in use. Fits up to 19.25"W x 9"D (489 mm x 230 mm) keyboards. Extends approximately 9" (230 mm) for full access to keyboard. Made of strong, lightweight aluminum.

19" Full Size Sliding Keyboard Tray

Tray holds full size keyboard with slide mounted under shelf to provide maximum tray width. Mounting hardware not included. Extends approximately 9" (230 mm) for full access to keyboard. Fits up to 19.25"W x 9"D (489 mm x 230 mm) keyboards. Made of strong, lightweight aluminum.

Note: Does not support the mouse pad attachment.

| Part Number | Description | Shipping Weight lb (kg) |
|-------------|-----------------------------|-------------------------|
| 12193-X01* | 19" Sliding Keyboard Tray | 9 (4.1) |
| 11546-X01 | 19" Full Size Keyboard Tray | 9 (4.1) |

X=color: 1=Gray, 2=Computer Beige, 5=Clear, 7=Black, E=Glacier White

*Also available, Mouse Pad Attachment (P/N 11692-XXX) and 23" Wrist Rest Attachment (P/N 12306-XXX).

Rack Base Insulator Kit

Rack Base Insulator Kits electrically isolate the racks from the floor for an effective grounding and bonding system.

Kit consists of:

- (2) isolation plates; (4) isolation grommets

| Part Number | Description | Shipping Weight lb (kg) |
|-------------|-------------------------|-------------------------|
| 10605-019 | Insulator Kit, 19" Rack | 3 (1.4) |
| 10605-023 | Insulator Kit, 23" Rack | 3 (1.4) |

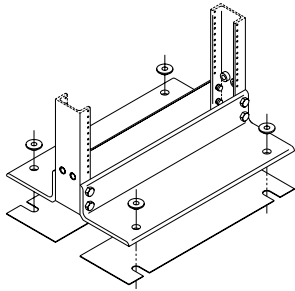

Rack and Frame Installation Kits

Required hardware for securing equipment racks and frames to both concrete and wood floors. Concrete Kit has four 3/8" thread components or four 1/2" thread components. Wood kit has four 3/8" thread components.

| Part Number | Floor Type | Finish | Shipping Weight lb (kg) |
|-------------|----------------------|--------|-------------------------|
| 40604-001 | Concrete Floor, 3/8" | Zinc | 1 (0.5) |
| 40604-003 | Concrete Floor, 1/2" | Zinc | 1 (0.5) |
| 40607-001 | Wood Floor, 3/8" | Zinc | 1 (0.5) |

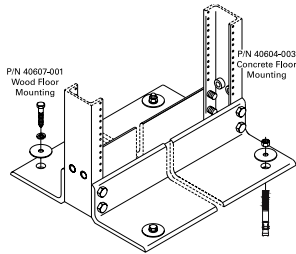

Raised Floor Rack Support Kit

Support racks installed on 4" to 36" (100 mm to 910 mm) height raised floor support systems. Mounted base floor using 5/8" threaded rods and steel brackets.

Kits consists of:

- (4) pre-cut threaded rods; (4) "Z" brackets; All mounting hardware

| 19" Rack | 23" Rack | Height of Floor in (mm) | Shipping Weight lb (kg) |
|---------------------------------|-----------|-------------------------|-------------------------|
| 3" (80 mm) Rack Channel | | | |
| 10632-119 | 10632-123 | 4 to 10 (100 to 250) | 15 (6.8) |
| 10629-119 | 10629-123 | 10 to 16 (250 to 410) | 18 (8.2) |
| 10630-119 | 10630-123 | 16 to 22 (410 to 560) | 20 (9.1) |
| 10631-119 | 10631-123 | 22 to 28 (560 to 710) | 23 (10.4) |
| 13501-119 | 13501-123 | 30 to 36 (760 to 910) | 34 (15.4) |
| 6" (150 mm) Rack Channel | | | |
| 11760-119 | 11760-123 | 4 to 10 (100 to 250) | 15 (6.8) |
| 11761-119 | 11761-123 | 10 to 16 (250 to 410) | 18 (8.2) |
| 11762-119 | 11762-123 | 16 to 22 (410 to 560) | 21 (9.5) |
| 11763-119 | 11763-123 | 22 to 28 (560 to 710) | 24 (10.9) |
| 13515-119 | 13515-123 | 30 to 36 (760 to 910) | 34 (15.4) |

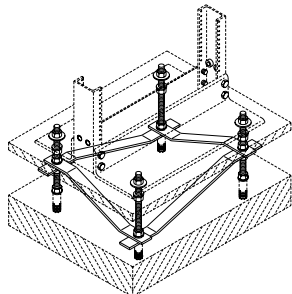

Rack with 3" (80 mm) channel shown

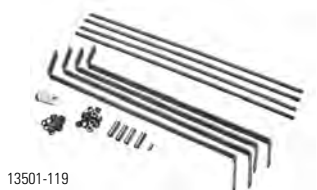

13501-119

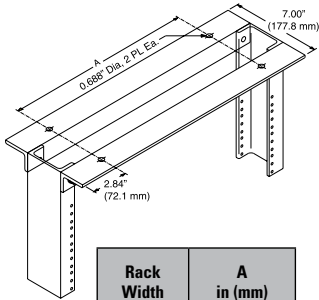

| Rack Width | A in (mm) |
|------------|---------------|
| 19" | 14.57 (370.1) |
| 23" | 18.57 (471.1) |

Heavy Duty Top Angle

Optional top angle for CPI Universal, 3\"D (80 mm) Standard or 6\"D (150 mm) Standard Rack.

- Material is aluminum extrusion
- Top Angle is L-shaped and 1-1/2\" x 2\" x 1/4\" (38 mm x 51 mm x 6.4 mm) thick
- Recommended for use in pairs with Universal Earthquake Bracing Kit P/N 10562-001
- Sold individually

| Part Number | Description | Shipping Weight lb (kg) |
|-------------|---------------|-------------------------|
| 10473-X01 | For 19\" Rack | 3 (1.4) |
| 10473-X02 | For 23\" Rack | 3 (1.4) |

X=Color: 1=Gray, 2=Computer Beige, 5=Clear, 7=Black, E=Glacier White

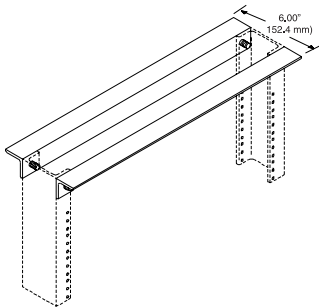

Top Angle

Optional top angles for CPI Universal Rack.

- Material is aluminum extrusion 1-1/2\" x 1-1/2\" x 1/4\" (38 mm x 38 mm x 6.4 mm)
- Sold individually

| Part Number | Description | Shipping Weight lb (kg) |
|-------------|---------------|-------------------------|
| 10375-X01 | For 19\" Rack | 3 (1.4) |
| 10375-X02 | For 23\" Rack | 3 (1.4) |

X=Color: 1=Gray, 2=Computer Beige, 5=Clear, 7=Black, E=Glacier White

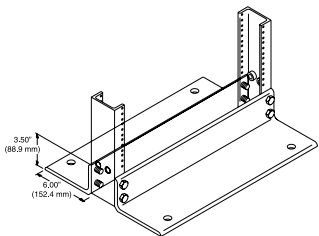

Base Angle

Optional base angle for CPI Universal Racks.

- Material is aluminum extrusion 3-1/2\" x 6\" x 3/8\" (89 mm x 150 mm x 9.53 mm)
- Sold individually

| Part Number | Description | Shipping Weight lb (kg) |
|-------------|---------------|-------------------------|
| 41021-X01 | For 19\" Rack | 10 (4.5) |
| 41021-X02 | For 23\" Rack | 10 (4.5) |

X=Color: 1=Gray, 2=Computer Beige, 5=Clear, 7=Black, E=Glacier White

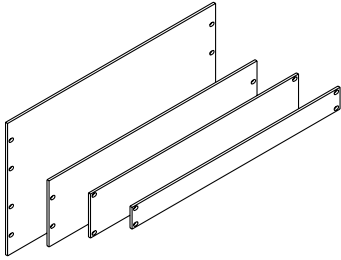

Filler Panels

For airflow control and/or equipment mounting, fill empty spaces between mounted equipment.

| Filler Panels | | | | |
|---------------|---------------------|------------------|---------------|----|
| 300 | Filler Panels | | | |
| | Thickness - in (mm) | | Width | |
| | 24 | 3/16 (4.763) | 19" | |
| | 25 | 3/16 (4.763) | 23" | |
| | 26 | 1/8 (3.18) | 19" | |
| | 27 | 1/8 (3.18) | 23" | |
| | Color | | | |
| | 1 | Gray | | |
| | 2 | Computer Beige | | |
| | 5 | Clear | | |
| | 7 | Black | | |
| | E | Glacier White | | |
| | | Spaces - in (mm) | | U |
| | | 01 | 1.72 (43.7) | 1 |
| | | 02 | 3.47 (88.1) | 2 |
| | | 03 | 5.22 (132.6) | 3 |
| | | 04 | 6.97 (177.0) | 4 |
| | | 05 | 8.72 (221.5) | 5 |
| | | 06 | 10.47 (265.9) | 6 |
| | | 07 | 12.22 (310.4) | 7 |
| | | 08 | 13.97 (354.8) | 8 |
| | | 09 | 15.72 (399.3) | 9 |
| | | 10 | 17.47 (443.7) | 10 |
| | | 11 | 19.22 (488.2) | 11 |
| | | 12 | 20.97 (532.6) | 12 |
| 300 | XX | - | X | XX |



12 oz (340 g)
pressurized can



25401-X00

Touch-Up Paint

Air dry lacquer for touching up finish. Matches color and gloss of CPI's textured paint. Air dries to hard finish in minutes.

- 12-ounce (340 g) pressurized can Note: Cannot be shipped via air.

Air dry waterborne paint for touching up finish. Matches color and gloss of CPI's textured paint.

- 1-ounce (30 g) bottle with applicator

| Part Number | Description oz (g) | Shipping Weight lb (kg) |
|-------------|--------------------|-------------------------|
| 25400-X00 | 12 (340) Can | 2 (0.9) |
| 25401-X00 | 1 (30) Bottle | 1 (0.5) |

X=Color; 1=Gray, 2=Computer Beige, 7=Black, E=Glacier White.

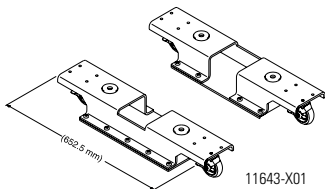

11643-X01

Note: Vertical cabling sections cannot be used on dolly-equipped racks. Also, dolly will not fit 6"D (150 mm) Standard Rack.

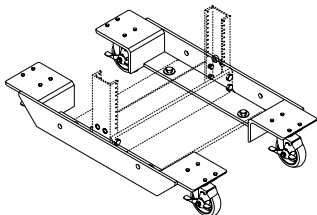

10175-X00

Note: Vertical cabling sections cannot be used on dolly-mounted racks. Can be used with Universal, 3"D (80 mm) Standard or 6"D (150 mm) Standard Racks.

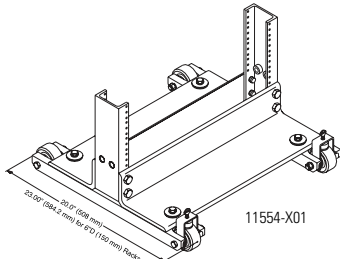

11554-X01

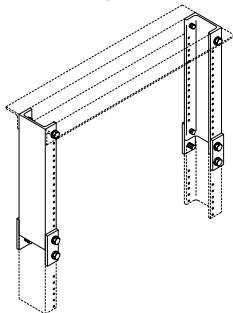

Mid-Size Rack Dolly

Full swivel capability allows rack to be easily moved, providing access to equipment. The front wheel locks to prevent unintentional movement. Mounts to most CPI Universal and Standard Racks and adds 1-1/4" (31.8 mm) to rack's height. Two-piece construction of 1/4" (6.4 mm) aluminum complete with hardware. Sold in pairs; load capacity 750 lb (340.2 kg).

Rack Universal Dolly Wheels

Allows rack to be moved, providing access to equipment. Wheels may be locked to prevent moving during assembly stages. Holds any width CPI Universal or Standard Rack. Two-piece construction of 3/8" (9.53 mm) aluminum complete with rack-mounting hardware. Supports up to 1000 lb (453.6 kg).

Note: Not to be used with enclosures.

Rack Standard Rollers

Mount to CPI Universal and Standard Racks, regardless of width. Fixed rollers prevent rack from accidental turning. Adds 2" (50 mm) to rack's height. Ships complete with installation hardware. Supports up to 500 lb (226.8 kg).

| Part Number | Description | Shipping Weight lb (kg) |
|-------------|--|-------------------------|
| 11643-X01 | Mid-Size Rack Dolly | 24 (10.9) |
| 10175-X00 | Universal Dolly Wheels | 20 (9.1) |
| 11554-X01 | Rack Standard Rollers, For 3"D (80 mm) Rack Channel | 8 (3.6) |
| 11554-X03 | Rack Standard Rollers, For 6"D (150 mm) Rack Channel | 8 (3.6) |

X=color: 1=Gray, 2=Computer Beige, 5=Clear, 7=Black

Rack Extension Kit

Provides additional height to existing racks. Kit includes one pair of rack channels, four plates and assembly hardware.

- Universal 5/8" - 5/8" - 1/2" (15.9 mm - 15.9 mm - 12.7 mm) hole pattern

| Part Number | Description | Shipping Weight lb (kg) |
|-------------|--------------------|-------------------------|
| 10565-X12 | 12"H (300 mm), 4U | 4 (1.8) |
| 10565-X24 | 24"H (610 mm), 11U | 6 (2.7) |

X=color: 1=Gray, 2=Computer Beige, 5=Clear, 7=Black, E=Glacier White

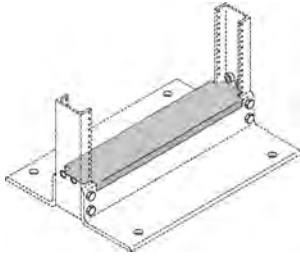

Rack Base Dust Cover

Improves appearance and prevents the accumulation of dust and debris at the rack base. Snaps securely in place over the base assembly; no mounting hardware necessary. Made of lightweight aluminum.

- For CPI Racks with 3"D or 6"D (80 mm or 150 mm) channel

| Part Number | | | Description in (mm) |
|-------------|-----------|-----------|----------------------|
| 19" Rack | 23" Rack | 35" Rack | |
| 41050-X19 | 41050-X23 | N/A | 3 (80) Rack Channel |
| 42050-X19 | 42050-X23 | 42050-X35 | 6 (150) Rack Channel |

X=color: 1=Gray, 2=Computer Beige, 5=Clear, 7=Black, E=Glacier White

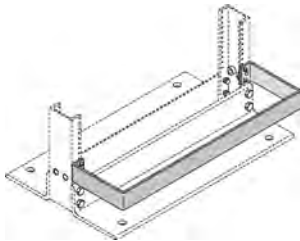

Equipment Guard Rail

Provides protection for equipment in racks from rolling gear or tool boxes.

- Made of 1/4" x 2" (6.4 mm x 50 mm) aluminum bar
- Mounting hardware is included; sold individually

| 400 | Equipment Guard Rails | | | |
|-----|----------------------------|----------------|---|----|
| | Stand Off - in (mm) | | | |
| | 56 | 7 (180) | | |
| | 57 | 6.5 (165) | | |
| | 58 | 5.25 (133.4) | | |
| | 59 | 4.25 (108) | | |
| | | Color | | |
| | 1 | Gray | | |
| | 2 | Computer Beige | | |
| | 5 | Clear | | |
| | 7 | Black | | |
| | E | Glacier White | | |
| | | Width | | |
| | 19 | 19" Rack | | |
| | 23 | 23" Rack | | |
| 400 | XX | - | X | XX |

Rack Panel Adapters (Pair)

Allows 19"W equipment to be mounted on a 23"W rack.

- Universal 5/8"- 5/8"-1/2" (15.9 mm - 15.9 mm - 12.7 mm)
- Joggled so that installed panels fit flush

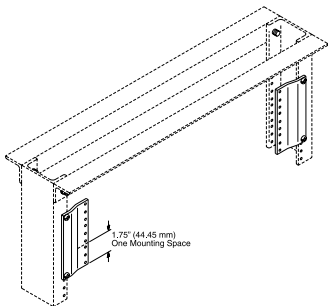

| Part Number | Description | Shipping Weight lb (kg) |
|-------------|---------------------------------|-------------------------|
| 31410-X00 | Adapter, Pair, 1U, 1.71 (43.4) | 1 (0.5) |
| 31420-X00 | Adapter, Pair, 2U, 3.46 (87.9) | 1 (0.5) |
| 31430-X00 | Adapter, Pair, 3U, 5.21 (132.3) | 1 (0.5) |
| 31440-X00 | Adapter, Pair, 4U, 6.96 (176.8) | 1 (0.5) |
| 31450-X00 | Adapter, Pair, 5U, 8.71 (221.2) | 1 (0.5) |

X=color: 1=Gray, 2=Computer Beige, 5=Clear, 7=Black, E=Glacier White

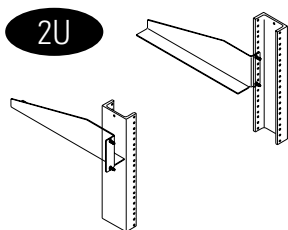

Sold in pairs. Attachment hardware not included.

Equipment Support Bracket

Equipment Support Bracket mounts to the rear rails to provide additional support and safety for deep or heavy electronic equipment panels and equipment mounted on CPI racks or cabinets.

- Supports equipment weighing up to 60 lbs (27.2 kg)
- Made of strong, lightweight aluminum
- Overall depth is 13" (330 mm); chassis support lip is 1.5"W (38 mm)
- Fits all EIA Standard, hole-patterned equipment mounting rails, cabinets and four-post racks
- Eliminates equipment deflection caused by cantilevered mounting

| Part Number | Description | Shipping Weight lb (kg) |
|-------------|------------------|-------------------------|
| 12312-X01 | Pair of Brackets | 2 (0.9) |

X=color: 1=Gray, 2=Computer Beige, 5=Clear, 7=Black, E=Glacier White



RMU Label Kits

Easy-to-read numbers take the guesswork out of aligning components.

- Two kits are available: 1-45U for 7' (2.1 m) racks and cabinets and 1-58U for 8' or 9' (2.4 m or 2.7 m) racks and cabinets
- Kit contains four individual label packs, enough for four racks or four cabinets
- Labels are constructed of 1/2"W (10 mm) durable polyester film with adhesive backing and are Black with U numbers printed in White

| Part Number | Description | Shipping Weight lb (kg) |
|-------------|-------------|-------------------------|
| 11927-001 | 1-45U Label | 1 (0.5) |
| 11927-002 | 1-58U Label | 1 (0.5) |

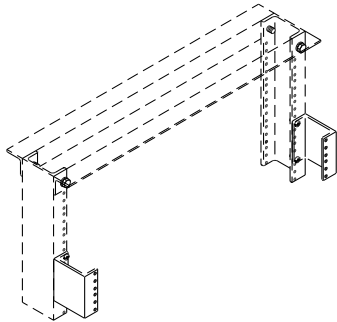

Rack Channel Standoffs

Rack Channel Standoffs offer solutions to many electronic component positioning problems, including:

- Adding deeper electronic components to existing CPI Wall Racks, Heavy Duty Wall Racks, Universal Swing Gate Wall Racks, Standard Swing Gate Wall Rack or Self-Support Racks
- Providing improved patch panel cable transitions when a double-sided cabling section is used with a 3" (80 mm) Rack Channel; use 1-1/2" (38 mm) Rack Channel Standoff
- Reposition rack-mounted electronic components to redistribute component weight or to realign component for whatever reason
- Available in three depths and six heights
- Packaged one pair per box

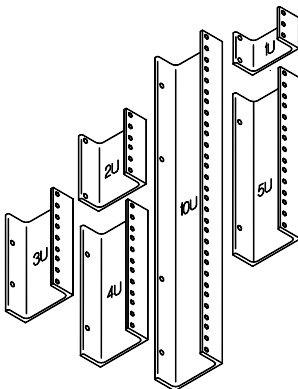

Front of channel tapped with #12-24 threaded holes, EIA 310 Universal holes spacing

| Part Number | Overall Height | Mounting Holes | Shipping Weight lb (kg) |
|---|----------------|----------------|-------------------------|
| 3" (80 mm) Rack Channel / 3" Depth (80 mm) | | | |
| 12309-X01 | 1U | 3 | 1 (0.5) |
| 12309-X02 | 2U | 6 | 1 (0.5) |
| 12309-X03 | 3U | 9 | 2 (0.9) |
| 12309-X04 | 4U | 12 | 2 (0.9) |
| 12309-X05 | 5U | 15 | 2 (0.9) |
| 12309-X10 | 10U | 30 | 4 (1.8) |
| 3" (80 mm) Rack Channel / 6" Depth (150 mm) | | | |
| 12310-X01 | 1U | 3 | 1 (0.5) |
| 12310-X02 | 2U | 6 | 1 (0.5) |
| 12310-X03 | 3U | 9 | 2 (0.9) |
| 12310-X04 | 4U | 12 | 2 (0.9) |
| 12310-X05 | 5U | 15 | 2 (0.9) |
| 12310-X10 | 10U | 30 | 4 (1.8) |
| 3" (80 mm) Rack Channel / 1-1/2" Depth (38 mm) | | | |
| 12311-X01 | 1U | 3 | 1 (0.5) |
| 12311-X02 | 2U | 6 | 1 (0.5) |
| 12311-X03 | 3U | 9 | 2 (0.9) |
| 12311-X04 | 4U | 12 | 2 (0.9) |
| 12311-X05 | 5U | 15 | 2 (0.9) |
| 12311-X10 | 10U | 30 | 4 (1.8) |

X=Color: 1=Gray, 2=Computer Beige, 5=Clear, 7=Black, E=Glacier White

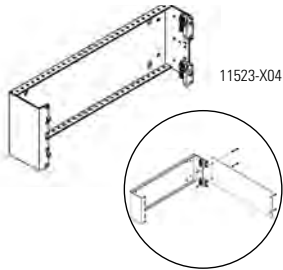

Hinged Panel Mounting Bracket

Provides easy access to back of wall or rack-mounted panels.

- Can be mounted to open left or right
- Available in 2, 3, 4, 5 or 6 mounting space, 1.75" H (44.45 mm), 4" or 8" D (100 mm or 200 mm) and 19" W
- Mounting hardware not included; supports up to 30 lb (13.6 kg) load

| Part Number | Description | Shipping Weight lb (kg) |
|-------------|-------------------------------------|-------------------------|
| 11521-X04 | 3.50 (88.9), 2U High, 4 (100) Deep | 2 (0.9) |
| 11522-X04 | 5.25 (133.4), 3U High, 4 (100) Deep | 2 (0.9) |
| 11523-X04 | 7.00 (177.8), 4U High, 4 (100) Deep | 2 (0.9) |
| 11524-X04 | 8.75 (222.3), 5U High, 4 (100) Deep | 2 (0.9) |
| 11525-X04 | 10.5 (267.0), 6U High, 4 (100) Deep | 2 (0.9) |

X=color: 1=Gray, 2=Computer Beige, 5=Clear, 7=Black, E=Glacier White
Also available in 8" D (200 mm), (-X08).

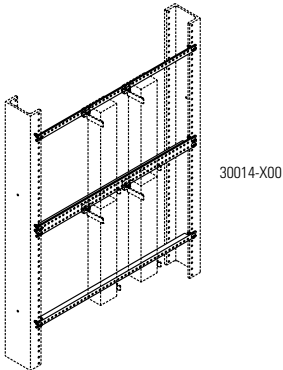

Block Mounting Bar, Rack-Mounted

For mounting terminal blocks, card files and other equipment on 19" and 23" racks.

- Angle mounting bars are 1/8" (3.18 mm) cold-rolled steel
- T-mounting bars are 1/8" (3.18 mm) extruded aluminum
- Hole patterns are 12-24 tapped on 7/16" (11.113 mm) centers
- Supports 66/89 Blocks; sold individually

| Part Number | Description | Shipping Weight lb (kg) |
|-------------|-------------|-------------------------|
| 30013-X00 | 19" Angle | 2 (0.9) |
| 30014-X00 | 23" Angle | 2 (0.9) |
| 30015-X00 | 19" T-Bar | 2 (0.9) |
| 30016-X00 | 23" T-Bar | 2 (0.9) |

X=color: 1=Gray, 2=Computer Beige, 5=Clear, 7=Black, E=Glacier White

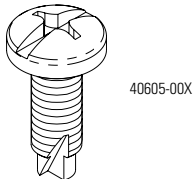

Combination Pan Head, Pilot Point, Mounting Screws

The #12-24 Combination Pan Head, Pilot Point, Mounting Screws attach equipment to racks and cabinets.

- Available in choice of Zinc plated or Black finish in packages of 50 and 1000
- The 4606 Combination Pan Head, Pilot Point, Sems Mounting Screws are similar to the 40605, except includes captive lock washer; Zinc plated finish

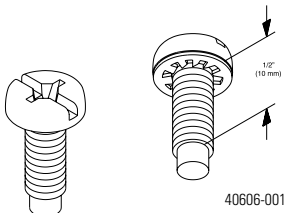

| Part Number | Nominal Size | Package | Of | Shipping Weight lb (kg) |
|-------------|---------------|---------|----|-------------------------|
| 40605-001 | 12-24 | 50 | | 1 (0.5) |
| 40605-004 | 12-24 | 1000 | | 9 (4.1) |
| 40605-005 | 12-24 (Black) | 50 | | 1 (0.5) |
| 40605-006 | 12-24 (Black) | 1000 | | 9 (4.1) |
| 40606-001 | 12-24 | 50 | | 1 (0.5) |

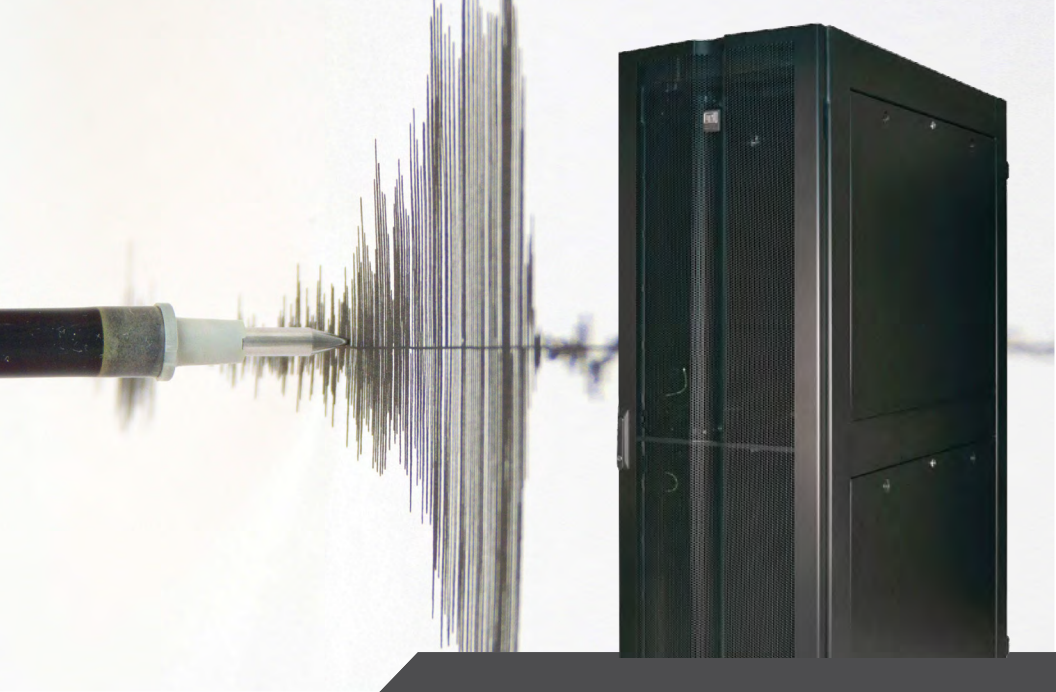

SECTION 9

SEISMIC PROTECTION SYSTEMS

| | |
|---|-----|
| SeismicFrame® Two-Post Rack..... | 9-3 |
| Seismic Protection Products - Racks..... | 9-5 |
| Seismic Protection Products - Cabinets..... | 9-7 |
| Seismic Protection Products - Runway | 9-8 |
| Z4-Series SeismicFrame® Cabinet..... | 9-9 |

SEISMIC PROTECTION SYSTEMS

Section Update:

- Patented Air Dam Kit

Page 9-12

Where Can I Learn More?

To learn more about CPI's Seismic Protection Systems, or to find additional part numbers not listed in this catalog, please visit our website, chatsworth.com

Related Tools:

Use these tools, under the Resources tab on chatsworth.com, to simplify your planning, selection, order and purchase of CPI Seismic Protection Systems.

- Visio Shapes
- CAD Blocks
- BIM Drawings
- MasterFormat Specs
- OSHPD Product

Your Notes Here:



Z4-Series SeismicFrame Cabinet



PATENTED



SeismicFrame Two-Post Rack

- Welded, steel network equipment rack engineered specifically to protect equipment in areas with seismic activity
- Available in two sizes: 24"W (610 mm) or 28"W (710 mm)
- Vertical Powers Strips and T-shaped Cable Management Fingers attach directly to the rack channel to provide power and cable distribution for equipment
- 19"W Rack fits within a 24" (610 mm) access floor tile
- Fully bonded rack has (2) masked bonding locations and includes a Two Mounting Hole Bonding Terminal Block for easy connection to the Secondary Bonding Busbar (SBB)
- Independently seismic-tested and certified, meets industry recognized Telecordia Technologies, Inc. GR-63-CORE Network Equipment Building Systems (NEBS) Zone 4 requirements
- EIA-310-E Compliant
- UL Listed NWIN per UL60950, File E227626
- 1000 lb (453.6 kg) load rating for seismic areas

Includes:

- (1) welded, steel frame
- (4) equipment mounting rails
- (50) each equipment mounting screws/cage nuts
- (1) Two Mounting Hole Bonding Terminal Block



SeismicFrame Two-Post Rack populated with available accessories



Adjustable Depth Mounting Rails



Two Mounting Hole Bonding Terminal Block

PATENTED

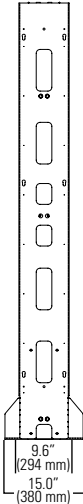
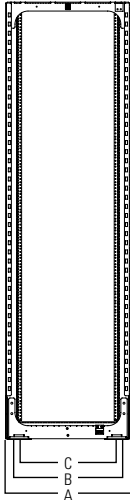

| Description | 19 in (mm) | 23 in (mm) |
|--------------------|-------------|-------------|
| Overall Width (A) | 24.0 (610) | 28.0 (710) |
| Frame Opening (B) | 19.3 (490) | 23.3 (592) |
| Rail Clearance (C) | 17.75 (450) | 21.75 (552) |

SeismicFrame Two-Post Rack

Open, two-post, seismic rack supports 19"W EIA or 23"W rack-mount equipment.

| Part Number | Description H x W ft (m) | Shipping Weight lb (kg) |
|-------------|--|----------------------------|
| 13853-X03 | 7 (2.1) x 19", 44U Tapped #12-24 Zinc Rails | 180 (81.6) |
| 13854-X03 | 7 (2.1) x 19", 44U Square-Punched Zinc Rails | 178 (80.7) |
| 13855-X03 | 7 (2.1) x 19", 44U Tapped #12-24 Painted Rails | 180 (81.6) |
| 13856-X03 | 7 (2.1) x 19", 44U Square-Punched Painted Rails | 178 (80.7) |
| 13883-X03 | 7 (2.1) x 23", 44U Tapped #12-24 Zinc Rails | 185 (83.9) |
| 13884-X03 | 7 (2.1) x 23", 44U Square-Punched Zinc Rails | 183 (83.0) |
| 13885-X03 | 7 (2.1) x 23", 44U Tapped #12-24 Painted Rails | 185 (83.9) |
| 13886-X03 | 7 (2.1) x 23", 44U Square-Punched Painted Rails | 183 (83.0) |

X=color; 1=Gray, 2=Computer Beige, 7=Black.

Install using (4) seismic-rated concrete anchors (sold separately).



Cable Management Fingers Kit

Organize patch cords and jumper cables by U space.

- 7U T-shaped plastic cable guides snap onto the front and rear of the rack frame
- Openings between the T-shaped guides align with each U space on the rack
- Single-Sided Kit includes 12 cable guides for one side (front or rear) of the rack
- Double-Sided Kit includes 24 cable guides for both sides (front and rear) of the rack

| Part Number | Description | Shipping Weight lb (kg) |
|-------------|---|----------------------------|
| 13696-001 | Cable Management Fingers Kit, Single-Sided | 7 (3.2) |
| 13696-002 | Cable Management Fingers Kit, Double-Sided | 14 (6.4) |

Color is Black.



13704-703



13699-701



13697-001



13698-001

SeismicFrame Two-Post Rack Accessories

VCS Vertical Cabling Section

Two aluminum cable managers, 6"W x 6.38"D (150 mm x 162 mm), attach to align with the front and rear of the rack. Large cable pass-through ports on the back of each manager align with openings in the side of the frame; spin-open plastic latches secure cables in managers. Attach two CPI Vertical Power Strips to slots on the back of the manager using the mounting kit listed below. One Single-Sided Cable Management Fingers Kit included to organize cables.

VCS Vertical Cabling Section Offset Bracket

Brackets attach a Single-Sided Wide VCS (P/N 11374-X03) to the SeismicFrame Two-Post Rack so that it aligns with the front of the rack. Kit includes four brackets: use two brackets per side to attach the cabling section.

Vertical Power Strip Mounting Kit

Includes mounting hardware that allows two CPI Vertical Power Strips to attach to the keyholes on the sides of the SeismicFrame Two-Post Rack or the back of the Vertical Cabling Section listed above. Cannot be used on the same side as the Vertical Cabling Section or Cable Management Fingers Kit.

Duplex Electrical Outlet Box

Provides a location for a power connection at the base of the rack. Includes a single-gang box for a single duplex receptacle and two self-tapping Torx head T25 installation screws. Outlet box is welded steel, 3-3/4"H x 1-13/16"W x 2-1/2"D (95 mm x 46 mm x 64 mm) with a 15.5 in² (250 cm²) wiring capacity, has eight (four accessible) concentric knockouts for 1/2" or 3/4" conduit and is zinc galvanized for corrosion protection. UL Listed.

| Part Number | Description | Shipping Weight lb (kg) |
|-------------|--|-------------------------|
| 13704-X03 | VCS Vertical Cabling Section | 35 (15.9) |
| 13699-701 | VCS Offset Mounting Bracket Kit, Black | 2 (0.9) |
| 13697-001 | Vertical Power Strip Mounting Kit | 1 (0.5) |
| 13698-001 | Duplex Electrical Outlet Box, Zinc | 1 (0.5) |

P/N 13704-X03, X=Color; 1=Gray, 2=Computer Beige, 7=Black

Universal Earthquake Bracing Kit

This adjustable wall/ceiling brace provides a means of securing an equipment rack or auxiliary frame to meet earthquake safety codes.

- Material is 2" x 1/4" (50 mm x 6.35 mm) steel finished with Gold Chem Film over zinc plating

Kit consists of:

- (4) brackets (make 2 swivel brackets)
- (2) 1/2-13 x 1 1/4" hex bolts
- (2) 1/2-13 hex nuts
- (2) 1/2" split lock washers

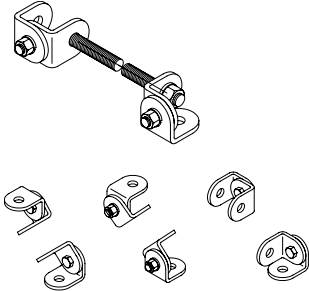

Installation Drawings:

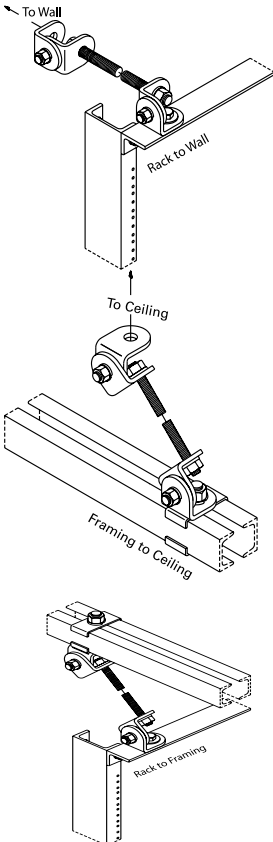

| Part Number | Description | Shipping Weight lb (kg) |
|-------------|----------------------------------|-------------------------|
| 10562-001 | Universal Earthquake Bracing Kit | 3 (1.4) |

Note: Seismic installation requirements should be approved by a licensed structural engineer.

Installation will require (not included):

- (1) 5/8-11 threaded rod of appropriate length
Rod must be trimmed to proper length during installation
- (2) 5/8-11 hex nuts
- (2) 5/8 flat Type A washer, wide
- Clip kit and hardware for attachment to channel or bar

Installation may also require (not included):

For concrete ceiling:

- (1) 5/8-11 concrete anchor
- (1) 5/8-11 x 3" stud
- (2) 5/8-11 hex nuts
- (1) 5/8" split lock washer
- (1) 5/8" flat, washer, wide, Type A

For rack:

- (1) 5/8-11 x 1 1/4" hex cap screw
- (1) 5/8-11 hex nut
- (1) 5/8" split lock washer

For auxiliary frame or grid:

- (1) Grid Clamp Kit
- (1) 5/8-11 x 3 1/4" hex screw cap
- (1) 5/8-11 hex nut
- (1) 5/8" split lock washer

For plywood backboard:

- (1) 5/8" x 2" hex lag screw
- (1) 5/8" split lock washer

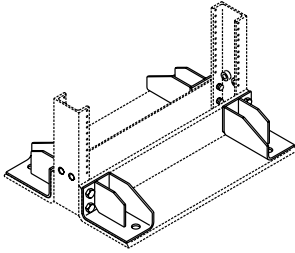

Rack Seismic Gusset Kit

The Rack Seismic Gusset and Hardware Kit can be added to any CPI Universal Rack (46XXX series) to stiffen critical load bearing joints, reducing the need to stabilize the top of the rack.

- Adds additional support to critical rack joints
- Kit can be added to any CPI Universal Rack (46XXX series)

Kit consists of:

- (4) welded steel bolt-on gussets
- (8) 1/2-13 x 1-1/4" bolts
- (8) 1/2-13 nuts

| Part Number | Description | Shipping Weight lb (kg) |
|-------------|-------------------------|-------------------------|
| 11592-X01 | Gusset and Hardware Kit | 10 (4.5) |

*X=*color; 1=Gray, 2=Computer Beige, 7=Black *Note: Seismic installation requirements should be approved by a licensed structural engineer.*

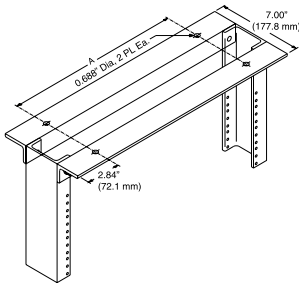

Heavy-Duty Top Angle

Optional top angle for CPI Universal, Standard or 6"D (150 mm) Standard Racks.

- Material is aluminum extrusion, 1 1/2" x 2" x 1/4" (38.1 mm x 51 mm x 6.4 mm) with two 11/16" (17.46 mm) punched holes in top surface
- Recommended to be used in pairs with 10562-001 bracing
- Sold individually

| Part Number | | | |
|-------------|---------------|-----------|---------------|
| 19" Rack | Dim. A | 23" Rack | Dim. A |
| 10473-X01 | 14.57 (370.1) | 10473-X02 | 18.57 (471.7) |

*X=*color; 1=Gray, 2=Computer Beige, 5=Clear, 7=Black, E=Glacier White

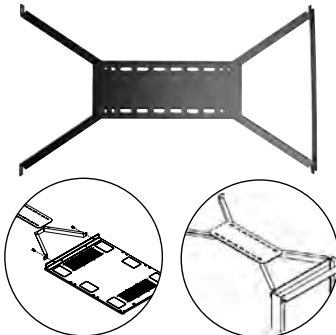

Adjustable Bracing Kits

For Racks and Cabinets:

Attach bracing kit to cabinet top panel where there is a risk of seismic activity. This adjustable, strong, easy-to-install rack bracing kit provides a cost-effective, attractive solution to bracing for equipment rack. Attaches directly to the wall.

- Adjustable 24" D to 36" D (610 mm to 910 mm) from wall
- Made of strong, lightweight aluminum
- Available in 19"W and 23"W
- Available in 4 colors to complement rack installations
- For use with M-Series, E-Series and SeismicFrame Cabinets

| Part Number | Description | Shipping Weight lb (kg) |
|-------------|-----------------------|-------------------------|
| 12477-X19 | 19"W Kit for Racks | 6 (2.7) |
| 12477-X23 | 23"W Kit for Racks | 7 (3.2) |
| 12407-X19 | 19"W Kit for Cabinets | 6 (2.7) |
| 12407-X23 | 23"W Kit for Cabinets | 7 (3.2) |

*X=*color; 1=Gray, 2=Computer Beige, 5=Clear, 7=Black

Note: For secure bracing, attach the rack/cabinet to the floor using the proper floor installation kit, along with CPI Floor Anchor Clamp provided with each cabinet.

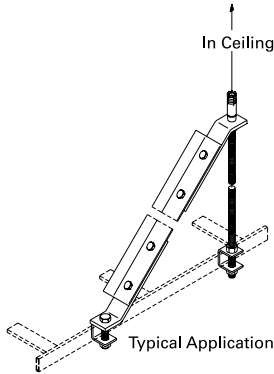

Earthquake Bracing Kits

Stabilizes Cable Runway hung from threaded rods. Material is 2" x 3/8" (50 mm x 9.53 mm) steel with gold over zinc plating.

Single Kit consists of:

- (2) steel bars (45° angle)
- (4) 1/2-13 x 1 1/4" hex nuts & cap screws
- (4) 1/2" split lock washers

Double Kit consists of:

- (2) steel bars (45° angle)
- (1) "V" steel bar
- (8) 1/2-13 x 1 1/4" hex cap screws
- (8) 1/2-13 hex nuts
- (8) 1/2" split lock washers

Installation will require (not included):

- Threaded rod and runway attachment hardware
 - (1) 2" x 2" x 3/16" (50 mm x 50 mm x 4.763 mm) steel angle of appropriate length.
- See P/N 11420 (angle must be trimmed to proper length and drilled during installation)

| Part Number | Description | Shipping Weight lb (kg) |
|-------------|-------------------------|-------------------------|
| 10695-001 | Single Earthquake Brace | 8 (3.6) |
| 10696-001 | Double Earthquake Brace | 14 (6.4) |

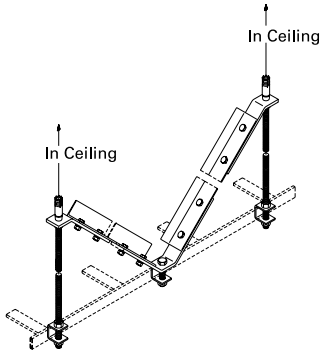

Installation may also require (not included):

For concrete ceiling:

- 5/8-11 concrete anchors
- 5/8-11 x 3 1/2" studs
- 5/8-11 hex nuts
- 5/8" split lock washers

For secondary structure:

- 5/8-11 threaded rod
- Grid Clamp Kits
- 5/8-11 hex cap screws
- 5/8-11 hex nuts
- 5/8" split lock washers

Note: Seismic installation requirements should be approved by a licensed structural engineer.



Load-Tested
GR-63
Zone 4

California
OSHPD
OPM-0112-13



OSHPD OPM-0112-13 provides pre-approved, code-compliant seismic designs of supports and attachments for the cabinet when used in health facilities in California.

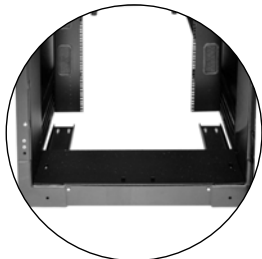

*Welded and bolted steel four-post frame.
Seismic Load is 1500 lb (680 kg).*

Z4-Series SeismicFrame Cabinet System

The Z4-Series SeismicFrame Cabinet System is an engineered solution specifically designed to store critical rack-mount server, data storage and network equipment in computer rooms, equipment rooms and other communications facilities that are located in active seismic areas.

Featuring an industry-leading 1500 lb (680 kg) equipment load, the Z4-Series SeismicFrame can also support an additional 100 lb (45 kg) top load for cabling. This cabinet was tested by a Telecommunications Carrier Group and ISO 17025 certified Independent Testing Laboratory (ITL) to meet the Telcordia Technologies GR-63-CORE, Issue 4, April 2012, Sections 4.4 per Zone 4 requirements. GR-63-CORE seismic testing includes a series of physical shaker table tests, during which a loaded cabinet is placed through simulated earthquake conditions. Zone 4 testing includes the most severe test conditions, in which the cabinet must perform with limited movement and survive the test without permanent structural or mechanical damage, ensuring the internal equipment is not damaged.

The cabinet is available with optional solid top panel, solid side panels and perforated doors. Top panel has four cable ports (one per corner). The side panels bolt on, and include locks. The front door is a single door with single point latch. The rear door is double (vertically split) with a three-point latch. Combine the Z4-Series SeismicFrame Cabinet with thermal and cable management accessories to create a solution that fits your exact needs.

Specifications:

- Available in 2 heights, 2 widths, 2 depths
- Provides front and rear support for 19"W (482.6 mm) EIA rack-mount equipment and shelves
- Adjustable depth, rails slide front-to-back
- Marks on frame for easy vertical alignment
- 1-3/4"H (44.45 mm) U spacing, marked and numbered
- 19"W, EIA-310-E Universal vertical hole spacing
- Seismic Load: 1500 lb (680 kg) internal seismic equipment load
100 lb (45 kg) additional cabinet roof load
- Static Load: 3000 lb (1360 kg) per UL2416

Cabinet Includes:

- Welded and bolted steel four-post frame
- Equipment mounting rails, two pairs
- Bonding/grounding system and bonding lug
- Recessed leveling feet
- Removable transport casters
- Baying kit
- Equipment mounting hardware, (50) M6 cage nuts and screws

Certifications:

- EIA-310-E compliant
- UL Listed 2416, NWN, File #E227626
- TCG NEBS Compliant, Telcordia Technologies, GR-63-CORE, Issue 4, April 2012, Sections 4.4, per Zone 4 requirements
- OSHPD OPM-0112-13 California, OSHPD, OPM

Cabinet Ordering Information:

Z4-Series SeismicFrame Cabinet is available in three basic configurations: a full cabinet with or without side panels, a cabinet with no doors with or without side panels or a frame only with no doors or panel work. Use the part number configurators below to select a Z4-Series SeismicFrame Cabinet. Choose Height, Width, Depth, Front Door, Locks and Sides based on your requirements. Example Cabinet Part Number: **Z4-12U-113C-C12**

Z4-Series SeismicFrame Cabinets - Frame with Top Panels and Doors, Side Panels are optional.

| Z4 | - | H | W | D | - | R | FD | RD | L | - | C | TP | SP |
|---------------|-----------|--------------------|----------------------------|---|------------|--------------------|----|----|---|---|---|----|----|
| Height | | | Rails | | | Side Panels | | | | | | | |
| U | in | mm | Square-Punched | | | 0 None | | | | | | | |
| 40 | 78.7 | 1999 | 1 | | | 2 Solid, 2 Each | | | | | | | |
| 43 | 83.9 | 2132 | 2 | | | | | | | | | | |
| Width | | | Front Doors | | | Top Panel | | | | | | | |
| in | mm | None | | | 1 Standard | | | | | | | | |
| 23.6 | 600 | 1 | | | | | | | | | | | |
| 31.5 | 800 | 2 | | | | | | | | | | | |
| Depth | | | Rear Doors | | | Color | | | | | | | |
| in | mm | Double, Perforated | | | C Black | | | | | | | | |
| 41.3 | 1050 | 3 | | | E Glacier | | | | | | | | |
| 47.3 | 1200 | U | | | White | | | | | | | | |
| | | | Latches | | | | | | | | | | |
| | | | 2-Point, Keyed | | | C | | | | | | | |
| | | | 2-Point, Keyed Combination | | | E | | | | | | | |



Z4-12U-113C-C12 shown

Z4-Series SeismicFrame Cabinets – Frame with Top Panel, no Doors, Side Panels are optional.

| Z4 | - | H | W | D | - | R | FD | RD | L | - | C | TP | SP |
|---------------|-----------|-----------|--------------------|---|------------|--------------------|----|----|---|---|---|----|----|
| Height | | | Rails | | | Side Panels | | | | | | | |
| U | in | mm | Square-Punched | | | 0 None | | | | | | | |
| 40 | 78.7 | 1999 | 1 | | | 2 Solid, 2 Each | | | | | | | |
| 43 | 83.9 | 2132 | 2 | | | | | | | | | | |
| Width | | | Front Doors | | | Top Panel | | | | | | | |
| in | mm | None | | | 1 Standard | | | | | | | | |
| 23.6 | 600 | 1 | | | | | | | | | | | |
| 31.5 | 800 | 2 | | | | | | | | | | | |
| Depth | | | Rear Doors | | | Color | | | | | | | |
| in | mm | None | | | C Black | | | | | | | | |
| 41.3 | 1050 | 0 | | | E Glacier | | | | | | | | |
| 47.3 | 1200 | U | | | White | | | | | | | | |
| | | | Latches | | | | | | | | | | |
| | | | None | | | 0 | | | | | | | |



Z4-12U-1000-C10 shown

Cabinet Ordering Information:

Z4-Series SeismicFrame Cabinets – Frame Only, No Top Panel, No Doors, or Side Panels.

| Z4 | - | H | W | D | - | R | FD | RD | L | - | C | TP | SP |
|---------------|------|------|---|---|---|--------------------|----------------|----|---|---|---|--------------------|----|
| Height | | | | | | Rails | | | | | | Side Panels | |
| U | in | mm | | | | | Square-Punched | | | | | 0 None | |
| 40 | 78.7 | 1999 | | | | | 1 | | | | | | |
| 43 | 83.9 | 2132 | | | | | | | | | | | |
| Width | | | | | | Front Doors | | | | | | Top Panel | |
| | in | mm | | | | | None | | | | | 0 None | |
| | 23.6 | 600 | | | | | | | | | | | |
| | 31.5 | 800 | | | | | | | | | | | |
| Depth | | | | | | Rear Doors | | | | | | Color | |
| | in | mm | | | | | None | | | | | C Black | |
| | 41.3 | 1050 | | | | | | | | | | E Glacier White | |
| | 47.3 | 1200 | | | | | | | | | | | |
| | | | | | | Latches | | | | | | | |
| | | | | | | None | | | | | | 0 | |



Z4-12U-1000-C00
shown

Specification/Ordering Notes:

- There are eight possible frame sizes.
- Use the first matrix to order a complete cabinet with top, doors and sides; use the second matrix to order a cabinet with no doors; use the last matrix to order a frame only with no top, doors or sides.
- You must include a top panel when ordering a cabinet with doors.
- You can order a cabinet with or without side panels.
- You can order a cabinet with or without front door.
- Choose latch/lock style: keyed or combination/keyed. Every door must have a latch. The (0) option should only be selected if there are no doors. Doors have a swing handle on the exterior. The combination lock uses a 3-digit combination entered on 3-dials that are integrated into the swing handle or a key. The combination lock can be reprogrammed in the field.
- The front door has a single-point latch; the rear door has a two-point latch.
- Heights, Widths, Depths: See tables below for detailed dimensions.

| Height Dimensions - in (mm) | | | |
|-----------------------------|----------------------|-----------------------|---------------|
| Rack Mount Spaces (U) | Overall with Casters | Frame Only No Casters | Front Opening |
| 40 | 78.7 (1999) | 77.4 (1965) | 70.4 (1789) |
| 43 | 83.9 (2132) | 82.6 (2099) | 75.7 (1922) |

Casters are factory-installed on the cabinet, used to move the cabinet into position and then removed before installation. The cabinet frame attaches directly to the floor.

| Depth Dimensions - in (mm) | | | |
|----------------------------|--------------------|---------------------|--------------------|
| Nominal Depth | Overall with Doors | Frame Only No Doors | Maximum Rail Depth |
| 800 | 35.4 (900) | 31.5 (800) | 29.3 (745) |
| 825 | 36.4 (925) | 32.5 (825) | 30.3 (770) |

Front Door is approximately 2.2"D (56 mm), and Rear Door is approximately 1.7"D (43 mm) with hinges/latches. Minimum rail is 10.2"D (258 mm). The front rail is 6.7"D (170 mm); the rear rail is 3.5"D (89 mm). Rail Depth is reduced when vertical accessories are placed in corners.

| Width Dimensions - in (mm) | | | |
|----------------------------|--------------------------|---------------|------------------------|
| Nominal Depth | Overall with Side Panels | Front Opening | Rack-Mount Panel Width |
| 600 | 23.6 (600) | 19.6 (498) | 19 (482.6) |
| 800 | 31.5 (800) | 27.5 (698) | 19 (482.6) |

Mounting Rail clearance is 17.8" (452 mm), mounting hole spacing is 18.3" (465 mm).



Air Dam Kit

Air Dam blocks airflow around the sides and top of the equipment mounting space, so cold air passes through equipment, and hot air does not recirculate around equipment.

- Use with Snap-In Filler Panels and Equipment Rail Grommet Kit
- Attaches to and adjusts with mounting rails
- Requires a minimum rail setback of 2.3" (58 mm) from the front of the frame
- Flexible seal against top and side panels
- Includes: Top, bottom and side baffles; installation hardware
- Material: Steel baffles, plastic seals
- Finish: Black or Glacier White; seals are Black
- Select part number to match the width, usable height and color of the cabinet

| Part Number | | Height (U) | Shipping Weight lb (kg) |
|-----------------|-----------------|------------|-------------------------|
| 23.6"W (600 mm) | 31.5"W (800 mm) | | |
| 14435-X00 | 14435-X02 | 40 | 14 (6.4) |
| 14435-X01 | 14435-X03 | 43 | 15 (6.8) |

X=Color, 0=Black, E=Glacier White. Shipping weights are for 800 mm kits.



Equipment Rail Grommet Kit

Set of Thermoplastic elastomer (TPE) grommets that cover cable openings in the equipment mounting rail to block airflow around equipment in the wider cabinets.

| Part Number | Description H x W (in) | Shipping Weight lb (kg) |
|-------------|---------------------------------------|-------------------------|
| 39133-001 | Equipment Rail Grommet Kit, Pack of 8 | 2 (0.9) |

Note: Color is Black. Use with 31.5"W (800 mm) rails.



Snap-In Filler Panel

Snap-In Filler Panels block airflow in-between equipment by sealing unused U spaces in the cabinet. Use with Air Dam to separate cold and hot air within the cabinet.

- Finish: Black or Glacier White
- Available in 1U and 2U heights, individual or bulk packs, color-matched to cabinet

| Part Number | | | Height (U) | Shipping Weight lb (kg) |
|-------------|-----------|-----------|------------|-------------------------|
| Each (1) | Pack (6) | Pack (50) | | |
| 34537-X00 | 34537-X01 | 34537-X02 | 1U | 14 (6.4) |
| 34538-X00 | 34538-X01 | 34538-X02 | 2U | 21 (9.5) |

X=Color, 0=Black, E=Glacier White. Shipping Weights are for 50 pack.

Front-To-Rear Cable Manager

Front-to-Rear Cable Manager attaches to the back of equipment mounting rails, creating a front-to-rear pathway between the front and rear mounting rails for cables.

- For use on 31.5"W (800 mm) cabinets
- Mounting locations behind cable openings on each rail
- Attaches to mounting rails and extends from 17.5"D (445 mm) to 30.5"D (775 mm) to match rail depth
- Creates a 3.0"H (76 mm) by 2.5"W (64 mm) front-to-rear pathway for cables
- Includes: Cable manager, installation hardware
- Material: Steel panels
- Finish: Black or Glacier White
- Select part number to match the color of the cabinet



| Part Number | | Rail Depth Range in (mm) | Shipping Weight lb (kg) |
|--------------------|--------------------|-----------------------------|-------------------------------|
| 23.6"W (600 mm) | 31.5"W (800 mm) | | |
| N/A | 14485-X00 | 17.5 - 30.5 (445 - 775) | 6 (2.7) |

X=Color, C=Black, E=Glacier White

Ring Cable Manager

Ring Cable Manager is independent of the equipment mounting rails, creating a separate vertical pathway for cables and includes plastic cable rings to organize cables.

- Attaches to the frame in a fixed location, independent of the equipment mounting rails
- Rings have an opening on the front for easy addition or removal of cables
- Includes: Brackets, rings, installation hardware
- Material: Steel brackets, plastic rings
- Finish: Black or Glacier White; rings are Black
- Select part number to match the width, usable height and color of the cabinet



| Part Number | | Rail Depth Range in (mm) | Shipping Weight lb (kg) |
|--------------------|--------------------|-----------------------------|-------------------------------|
| 23.6"W (600 mm) | 31.5"W (800 mm) | | |
| 14440-X00 | 14445-X00 | 40 | 13 (5.9) |
| 14440-X01 | 14445-X01 | 43 | 13 (5.9) |

X=Color, C=Black, E=Glacier White. Shipping weights are for 800 mm managers.

| Inside Dimensions, Usable Internal Cable Area, Rails Setback | | | | |
|--|------------------|------------------|--|-------------------------|
| Cabin Width | Width in (mm) | Depth in (mm) | Cable Area in ² (mm ²) | Rail Setback in (mm) |
| 23.6 (600) | .9 (29) | 3.3 (84) | 2.9 (1870) | 9.5 (240) |
| 31.5 (800) | 4.2 (107) | 3.5 (89) | 14.7 (9480) | 9.7 (246) |

Note: Rail setback is the minimum distance required between the front edge of the cabinet frame and the front edge of the equipment mounting rail.



Cable Lashing Bracket

Cable Lashing Bracket creates a simple, separate vertical pathway for a small bundle of cables and has multiple slots for CPI Saf-T-Grip® Straps or tie wraps to secure cables to the bracket.

- Attaches to the frame in a fixed location, independent of the equipment mounting rails
- Use multiple to increase capacity
- Bracket is 1.6"W (41 mm)
- Includes: Brackets, installation hardware; order Saf-T-Grips or cable ties separately
- Material: Steel, Finish: Black or Glacier White
- Select part number to match the usable height and color of the cabinet

| Part Number | Height (U) | Shipping Weight lb (kg) |
|-------------|------------|-------------------------|
| 14465-X00 | 40 | 3 (1.4) |
| 14465-X01 | 43 | 3 (1.4) |

X=Color, C=Black, E=Glacier White



Full Height Dual PDU Bracket

Full Height Dual PDU Bracket supports two vertical PDUs side-by-side and has multiple slots for CPI Saf-T-Grip Straps or tie wraps to secure cords to the bracket.

- Attaches to the frame in a fixed location, independent of the equipment mounting rails
- Available in (2) widths: Dual and Wide
- Dual bracket is 4.8"W (121 mm) and supports (2) PDUs up to 2.2"W (51 mm) side-by-side
- Wide bracket is 5.8"W (147 mm) and supports (2) PDUs up to 2.7"W (69 mm) side-by-side
- Wide bracket is required to mount (2) 6-breaker eConnect® PDUs (series P/Ns PX-3XXXX) side-by-side; eConnect PDUs (series P/Ns PX-3XXXX) will only fit in the 43U cabinet.
- Tool-less mounting on 28" (711 mm), 61.25" (1556 mm) or 64.75" (1645 mm) centers
- Includes: Brackets, installation hardware; order Saf-T-Grips or cable ties separately
- Material: Steel
- Finish: Black or Glacier White
- Select part number to match PDU size, usable height and color of the cabinet

| Part Number | | Height (U) | Shipping Weight lb (kg) |
|-------------|-----------|------------|-------------------------|
| Dual | Wide | | |
| 14480-X00 | 14481-X00 | 40 | 12 (5.4) |
| 14480-X01 | 14481-X01 | 43 | 11 (5.0) |

X=Color, C=Black, E=Glacier White. Shipping weights are for wide managers. eConnect PDU (P/Ns PX-3XXXX) will not fit inside a 40U cabinet.



SECTION 10

WALL-MOUNT SYSTEMS

| | | | |
|--|------|--------------------------------------|-------|
| Wall-Mount Racks – Standard Swing | 10-4 | CUBE-iT® Wall-Mount Cabinet | 10-11 |
| Wall-Mount Racks – EasySwing | 10-5 | CUBE-iT® Wall-Mount | |
| Wall-Mount Racks – Heavy-Duty Equipment..... | 10-6 | Floor-Supported Cabinet..... | 10-15 |
| Wall-Mount Racks – Fixed | 10-7 | ThinLine® II Wall-Mount Cabinet..... | 10-19 |
| Standard Wall-Mount Cabinet..... | 10-9 | | |

WALL-MOUNT SYSTEMS

Section Update:

- CUBE-iT® Wall-Mount Cabinet Page 10-11

Where Can I Learn More?

To learn more about CPI's Wall-Mount Systems, or to find additional part numbers not listed in this catalog, please visit our website, chatsworth.com

Related Tools:

Use these tools, under the Resources tab on chatsworth.com, to simplify your planning, selection, order and purchase of CPI Wall-Mount Systems.

- Visio Shapes
- CAD Blocks
- BIM Drawing
- MasterFormat Specs
- OSHPD Products

Your Notes Here:



CUBE-iT Wall-Mount Cabinet



Open Mounting



Closed Mounting

Wall-Mount Systems

Available in open and enclosed systems, wall-mounted racks and cabinets are an excellent choice to support equipment when floor space is limited or where a small group of users exist.

Open wall-mount racks present easy access to cables and equipment and offer both fixed and swing frames. Swing frames pivot open on one side to provide access to the rear of equipment and are used to support patch panels, while fixed frames hold more weight and are used for network routers and switches.

Enclosed wall-mount cabinets provide added physical security and are available in vertical, hinged and floor-supported designs. Vertical cabinets hold equipment against the wall to minimize the depth of the cabinet. Use vertical cabinets to support a small group of network users. Hinged cabinets provide access to the front and the rear of equipment. The cabinet body is hinged near the wall and can swing open to access cable terminations and the rear of equipment. Floor-supported cabinets are also hinged, but the cabinet body is supported from the floor with casters. This type of cabinet can hold more weight than wall-mounted hinged cabinets and are used to replace a freestanding rack in small rooms where added equipment security is required.

Open Systems

| Product | Purpose | Load Rating—lb (kg) |
|---|--|---------------------|
| Standard Swing Gate Wall Rack Page 10-4 | General use, swing frame used to support network equipment for a medium size group of users. UL Listed | Up to 150 (68.0) |
| EasySwing Wall-Mount Rack Page 10-5 | Affordable, swing frame used to support network equipment for a small group of users. Ships preassembled | Up to 85 (38.6) |
| Heavy-Duty Wall-Mount Equipment Rack Page 10-6 | Strong, fixed frame used to support network equipment for a medium size group of users and other heavy equipment | Up to 350 (158.8) |
| Fixed Wall-Mount Equipment Rack Page 10-7 | Basic, fixed frame used to support network equipment for a small group of users. UL Listed | Up to 200 (90.7) |

Enclosed Systems

| | | |
|--|---|--------------------|
| Standard Wall-Mount Cabinet Page 10-9 | Structurally advanced metal enclosure; arrives partially assembled in a compact, flat pack. Assemble using simple slot-and-hook design. | Up to 130 (58.9) |
| CUBE-iT® Wall-Mount Cabinet Page 10-11 | Feature rich, hinged cabinet used to secure network connections for a medium size group of users. Five-inch deep rear panel allows conduit to terminate at back of cabinet. UL Listed | Up to 200 (90.7) |
| CUBE-iT Wall-Mount Floor-Supported Cabinet Page 10-15 | Feature rich, hinged and floor-supported wall cabinet replaces floor supported network equipment in small equipment rooms | Up to 1000 (453.6) |
| ThinLine II Wall-Mount Cabinet Page 10-19 | Space-saving cabinet used to secure network connections for a small group of users. Ideal for high-traffic areas | Up to 100 (45.4) |



Standard Swing Gate Wall Rack

The Standard Swing Gate Wall Rack provides easy access to the rear of equipment, making it the ideal choice for supporting patch panels and switches.

- Dual hinges open to right or left, stopping in 90° position
- EIA-310-E compliant
- Universal 5/8" - 5/8" - 1/2" (15.9 mm - 15.9 mm - 12.7 mm) alternating hole pattern
- Rack-mount spaces are marked and numbered
- Includes (50) #12-24 mounting screws.
- Supports 100 lb (45.4 kg) of equipment in the open and closed position
- Load capacity can be increased to 150 lb (68 kg) with optional Heavy Duty Kit
- Supports single-sided and double-side shelves
- Ships partially assembled with installation hardware

| Standard Swing Gate Wall Rack | | | | | | | |
|-------------------------------|-------------------|--------|----------|--------------------|------------|------------|-------------------------|
| Part Number | Height | Width | Depth | Height | Width | Depth | Shipping Weight lb (kg) |
| | Usable Dimensions | | | Overall Dimensions | | | |
| 11790-X12 | 12U | 19"EIA | 11 (280) | 29.1 (739) | 21.7 (551) | 12.2 (310) | 22 (10.0) |
| 11790-X18 | 12U | 19"EIA | 17 (430) | 29.1 (739) | 21.7 (551) | 18.2 (462) | 24 (10.9) |
| 11790-X25 | 12U | 19"EIA | 24 (610) | 29.1 (739) | 21.7 (551) | 25.2 (640) | 42 (19.1) |
| 11791-X12 | 20U | 19"EIA | 11 (280) | 43.1 (1095) | 21.7 (551) | 12.2 (310) | 24 (10.9) |
| 11791-X18 | 20U | 19"EIA | 17 (430) | 43.1 (1095) | 21.7 (551) | 18.2 (462) | 26 (11.8) |
| 11791-X25 | 20U | 19"EIA | 24 (610) | 43.1 (1095) | 21.7 (551) | 25.2 (640) | 46 (20.9) |
| 11807-X12 | 26U | 19"EIA | 11 (280) | 53.6 (1361) | 21.7 (551) | 12.2 (310) | 25 (11.3) |
| 11807-X18 | 26U | 19"EIA | 17 (430) | 53.6 (1361) | 21.7 (551) | 18.2 (462) | 26 (11.8) |
| 11807-X25 | 26U | 19"EIA | 24 (610) | 53.6 (1361) | 21.7 (551) | 25.2 (640) | 50 (22.7) |
| 11792-X12 | 40U | 19"EIA | 11 (280) | 78.1 (1984) | 21.7 (551) | 12.2 (310) | 31 (14.1) |
| 11792-X18 | 40U | 19"EIA | 17 (430) | 78.1 (1984) | 21.7 (551) | 18.2 (462) | 33 (15.0) |
| 11792-X25 | 40U | 19"EIA | 24 (610) | 78.1 (1984) | 21.7 (551) | 25.2 (640) | 60 (27.2) |
| 11793-X12 | 12U | 23" | 11 (280) | 29.1 (739) | 25.7 (653) | 12.2 (310) | 23 (10.4) |
| 11793-X18 | 12U | 23" | 17 (430) | 29.1 (739) | 25.7 (653) | 18.2 (462) | 25 (11.3) |
| 11793-X25 | 12U | 23" | 24 (610) | 29.1 (739) | 25.7 (653) | 25.2 (640) | 43 (19.5) |
| 11794-X12 | 20U | 23" | 11 (280) | 43.1 (1095) | 25.7 (653) | 12.2 (310) | 25 (11.3) |
| 11794-X18 | 20U | 23" | 17 (430) | 43.1 (1095) | 25.7 (653) | 18.2 (462) | 27 (12.2) |
| 11794-X25 | 20U | 23" | 24 (610) | 43.1 (1095) | 25.7 (653) | 25.2 (640) | 47 (21.3) |
| 11808-X12 | 26U | 23" | 11 (280) | 53.6 (1361) | 25.7 (653) | 12.2 (310) | 26 (11.8) |
| 11808-X18 | 26U | 23" | 17 (430) | 53.6 (1361) | 25.7 (653) | 18.2 (462) | 28 (12.7) |
| 11808-X25 | 26U | 23" | 24 (610) | 53.6 (1361) | 25.7 (653) | 25.2 (640) | 51 (23.1) |
| 11795-X12 | 40U | 23" | 11 (280) | 78.1 (1984) | 25.7 (653) | 12.2 (310) | 32 (14.5) |
| 11795-X18 | 40U | 23" | 17 (430) | 78.1 (1984) | 25.7 (653) | 18.2 (462) | 34 (15.4) |
| 11795-X25 | 40U | 23" | 24 (610) | 78.1 (1984) | 25.7 (653) | 25.2 (640) | 61 (27.7) |

X=color: 1=Gray, 2=Computer Beige, 7=Black, E=Glacier White

Note: Usable depth is reduced at the top and bottom U to 8" (200 mm) on -X12; 12" (300 mm) on -X18; and 19" (462 mm) on -X25 racks.



Heavy Duty Swing Gate Kit increases the load bearing capacity of P/Ns (-X18) and (-X25) Standard Swing Gate Wall Racks to 150 lb (68 kg). Hardware included.

| Part Number | Description | Shipping Weight lb (kg) |
|-------------|---------------------------------------|-------------------------|
| 12795-X01 | Heavy Duty Swing Gate Kit, 2 Brackets | 4 (1.8) |

X=color: 1=Gray, 2=Computer Beige, 7=Black, E=Glacier White.

EasySwing Wall-Mount Rack

The EasySwing Wall-Mount Rack is a cost-effective 19" EIA swing gate rack for mounting network, communications and security equipment in a telecommunications or equipment room where floor space is limited.

- Opens 180° to right or left, locking latch pin secures gate in closed position. Includes lanyard for attachment to rack
- 19" EIA threaded equipment mounting rails
- Includes reusable cable management straps
- Durable all-steel construction
- Ships fully assembled and flat; simply unfold and mount to wall
- Keyhole wall mounting holes with mounting template included on carton
- Includes (12) #12-24 equipment mounting screws. Order 1/4" installation hardware separately
- Supports 85 lb (38.6 kg) of equipment



Ships flat



| Easy Swing Wall-Mount Rack | | | | | | | |
|----------------------------|-------------------|--------|------------|--------------------|------------|------------|-------------------------|
| Part Number | Height | Width | Depth | Height | Width | Depth | Shipping Weight lb (kg) |
| | Usable Dimensions | | | Overall Dimensions | | | |
| 13602-X08 | 11U | 19"EIA | 6.5 (165) | 24.5 (622) | 20.3 (516) | 8.0 (204) | 22 (10.0) |
| 13602-X12 | 11U | 19"EIA | 10.5 (266) | 24.5 (622) | 20.3 (516) | 12.0 (305) | 24 (10.9) |
| 13602-X18 | 11U | 19"EIA | 16.5 (419) | 24.5 (622) | 20.3 (516) | 18.0 (457) | 28 (12.7) |
| 13602-X25 | 11U | 19"EIA | 23.5 (596) | 24.5 (622) | 20.3 (516) | 25.0 (635) | 34 (15.4) |
| 13604-X08 | 19U | 19"EIA | 6.5 (165) | 38.5 (978) | 20.3 (516) | 8.0 (204) | 27 (12.2) |
| 13604-X12 | 19U | 19"EIA | 10.5 (266) | 38.5 (978) | 20.3 (516) | 12.0 (305) | 29 (13.2) |
| 13604-X18 | 19U | 19"EIA | 16.5 (419) | 38.5 (978) | 20.3 (516) | 18.0 (457) | 33 (15.0) |
| 13604-X25 | 19U | 19"EIA | 23.5 (596) | 38.5 (978) | 20.3 (516) | 25.0 (635) | 38 (17.2) |
| 13608-X12 | 26U | 19"EIA | 10.5 (266) | 51.5 (1308) | 20.3 (516) | 12.0 (305) | 33 (15.0) |
| 13608-X18 | 26U | 19"EIA | 16.5 (419) | 51.5 (1308) | 20.3 (516) | 18.0 (457) | 37 (16.8) |

*X=*color: 1=Gray, 2=Computer Beige, 7=Black, E=Glacier White

Note: Usable depth is reduced at the top and bottom 2U on -X08 and -X12 models and at the top and bottom 3U on -X18 and -X25 models. For planning purposes, reduce usable depth by 75% and 50% on the top and bottom 2U of -X08 and -X12 racks. Reduce usable depth by 80%, 50% and 25% on the top and bottom 3U of -X18 and -X25 racks.



Includes double-sided adhesive squares for easy installation

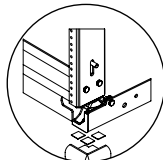

Corner Cushions

Since wall racks are elevated above the floor and extend away from the wall, bumping into the rack is a safety concern. Corner Cushions cover the exposed leading edges of racks for added protection.

- Flame retardant, non-toxic
- Foam design conforms to ASTM standards for safety surfacing material

| Part Number | Description | Shipping Weight lb (kg) |
|-------------|---------------------------|-------------------------|
| 12858-001 | Corner Cushions, Set of 4 | 1 (0.5) |



Heavy-Duty Wall-Mount Equipment Rack

Use the Heavy Duty Wall-Mount Equipment Rack to hold up to 350 lb (158.8 kg). The 24"D (610 mm) allows larger equipment to be wall-mounted. Quick and easy assembly has been engineered in to save you valuable installation time. Includes assembly hardware and mounting 1/4" x 2" lag bolts. Sold individually.

- 12-24 roll-formed threads on 5/8"-5/8"-1/2" (15.9 mm -15.9 mm -12.7 mm) spacing, both sides
- U spaces are marked and numbered
- Made of high-strength, lightweight aluminum
- Includes (50) #12-24 mounting screws. Black painted racks ship with black screws; other racks ship with zinc screws
- Holds up to 350 lb (158.8 kg) when securely mounted to wall or backboard

| Heavy-Duty Wall-Mount Equipment Rack | | | | | | | |
|--------------------------------------|-------------------|--------|----------|--------------------|------------|------------|-------------------------|
| Part Number | Height | Width | Depth | Height | Width | Depth | Shipping Weight lb (kg) |
| | Usable Dimensions | | | Overall Dimensions | | | |
| 15320-X18 | 20U | 19"EIA | 18 (457) | 41.2 (1046) | 23.0 (584) | 18.0 (457) | 22 (10.0) |
| 15320-X24 | 20U | 19"EIA | 24 (610) | 41.2 (1046) | 23.0 (584) | 24.0 (610) | 27 (12.2) |
| 15321-X18 | 40U | 19"EIA | 18 (457) | 76.2 (1935) | 23.0 (584) | 18.0 (457) | 28 (12.7) |
| 15321-X24 | 40U | 19"EIA | 24 (610) | 76.2 (1935) | 23.0 (584) | 24.0 (610) | 32 (14.5) |
| 15322-X18 | 20U | 23" | 18 (457) | 41.2 (1046) | 27.0 (686) | 18.0 (457) | 23 (10.4) |
| 15322-X24 | 20U | 23" | 24 (610) | 41.2 (1046) | 27.0 (686) | 24.0 (610) | 29 (13.2) |
| 15323-X18 | 40U | 23" | 18 (457) | 76.2 (1935) | 27.0 (686) | 18.0 (457) | 29 (13.2) |
| 15323-X24 | 40U | 23" | 24 (610) | 76.2 (1935) | 27.0 (686) | 24.0 (610) | 34 (15.4) |

X=Color: 1=Gray, 2=Computer Beige, 5=Clear, 7=Black, E=Glacier White



11583-XXX

Flush-Mounted Wall Bracket

Use the Flush-Mounted Wall Bracket to mount up to 6U of rack-mounted equipment, vertically, and flush to a wall. Ideal for areas where space is limited. The bracket has square-punched mounting rails and includes a pack of 25 Clic-Nut. Supports 150 lb (68 kg). Wall mounting hardware not included.

| Part Number | Description |
|-------------|---------------------------------|
| 11583-X19 | 3U x 19", Flush-Mounted Bracket |
| 11754-X19 | 6U x 19", Flush-Mounted Bracket |

X=Color: 1=Gray, 2=Computer Beige, 7=Black, E=Glacier White



11754-XXX



Fixed Wall-Mount Equipment Rack

The Fixed Wall-Mount Equipment Rack is a sturdy platform for wall mounting equipment.

- EIA-310-E compliant equipment mounting system, punched with the Universal alternating 5/8"-5/8"-1/2"(15.9 mm -15.9 mm -12.7 mm) hole pattern
- U spaces are marked and numbered, tapped with #12-24 roll-formed threads
- Includes (50) #12-24 equipment mounting screws. Black painted racks ship with black screws; other racks ship with zinc screws
- Supports single-sided and double-sided shelves
- Supports 200 lb (90.7 kg) of equipment when securely mounted to wall or backboard using all eight leg mounting holes

| Fixed Wall-Mount Equipment Rack | | | | | | | |
|---------------------------------|-------------------|--------|----------|--------------------|------------|------------|-------------------------|
| Part Number | Height | Width | Depth | Height | Width | Depth | Shipping Weight lb (kg) |
| | Usable Dimensions | | | Overall Dimensions | | | |
| 11960-X06 | 12U | 19"EIA | 6 (150) | 27.4 (696) | 22.4 (569) | 6.6 (168) | 9 (4.1) |
| 11960-X12 | 12U | 19"EIA | 12 (300) | 27.4 (696) | 22.4 (569) | 12.6 (320) | 12 (5.4) |
| 11960-X18 | 12U | 19"EIA | 18 (457) | 27.4 (696) | 22.4 (569) | 18.6 (472) | 13 (5.9) |
| 11961-X06 | 20U | 19"EIA | 6 (150) | 41.4 (1052) | 22.4 (569) | 6.6 (168) | 10 (4.5) |
| 11961-X12 | 20U | 19"EIA | 12 (300) | 41.4 (1052) | 22.4 (569) | 12.6 (320) | 13 (5.9) |
| 11961-X18 | 20U | 19"EIA | 18 (457) | 41.4 (1052) | 22.4 (569) | 18.6 (472) | 15 (6.8) |
| 11962-X06 | 40U | 19"EIA | 6 (150) | 76.4 (1941) | 22.4 (569) | 6.6 (168) | 15 (6.8) |
| 11962-X12 | 40U | 19"EIA | 12 (300) | 76.4 (1941) | 22.4 (569) | 12.6 (320) | 16 (7.3) |
| 11962-X18 | 40U | 19"EIA | 18 (457) | 76.4 (1941) | 22.4 (569) | 18.6 (472) | 20 (9.1) |
| 11963-X06 | 12U | 23" | 6 (150) | 27.4 (696) | 26.4 (671) | 6.6 (168) | 10 (4.5) |
| 11963-X12 | 12U | 23" | 12 (300) | 27.4 (696) | 26.4 (671) | 12.6 (320) | 11 (5.0) |
| 11963-X18 | 12U | 23" | 18 (457) | 27.4 (696) | 26.4 (671) | 18.6 (472) | 13 (5.9) |
| 11964-X06 | 20U | 23" | 6 (150) | 41.4 (1052) | 26.4 (671) | 6.6 (168) | 11 (5.0) |
| 11964-X12 | 20U | 23" | 12 (300) | 41.4 (1052) | 26.4 (671) | 12.6 (320) | 12 (5.4) |
| 11964-X18 | 20U | 23" | 18 (457) | 41.4 (1052) | 26.4 (671) | 18.6 (472) | 15 (6.8) |
| 11965-X06 | 40U | 23" | 6 (150) | 76.4 (1941) | 26.4 (671) | 6.6 (168) | 16 (7.3) |
| 11965-X12 | 40U | 23" | 12 (300) | 76.4 (1941) | 26.4 (671) | 12.6 (320) | 17 (7.7) |
| 11965-X18 | 40U | 23" | 18 (457) | 76.4 (1941) | 26.4 (671) | 18.6 (472) | 19 (8.6) |

X=color: 1=Gray, 2=Computer Beige, 5=Clear, 7=Black, E=Glacier White

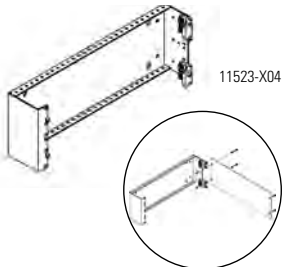

Hinged Panel Mounting Bracket

Provides easy access to back of wall or rack-mounted panels.

- 1.75"H (44.45 mm), 4" or 8"D (100 mm or 200 mm) and 19"W
- Mounting hardware not included; supports up to 30 lb (13.6 kg) load

| Part Number | Description in (mm) | Shipping Weight lb (kg) |
|-------------|-------------------------------------|-------------------------|
| 11521-X04 | 3.50 (88.9), 2U High, 4 (100) Deep | 2 (0.9) |
| 11522-X04 | 5.25 (133.4), 3U High, 4 (100) Deep | 2 (0.9) |
| 11523-X04 | 7.00 (177.8), 4U High, 4 (100) Deep | 2 (0.9) |
| 11524-X04 | 8.75 (222.3), 5U High, 4 (100) Deep | 2 (0.9) |
| 11525-X04 | 10.5 (267.0), 6U High, 4 (100) Deep | 2 (0.9) |

2U

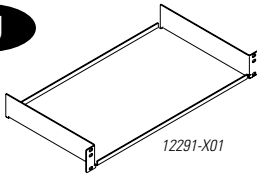

3U

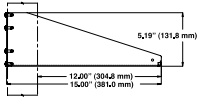
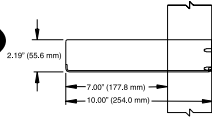

Shelves

- 15" (380 mm) shelf mounts in 18"D (460 mm) racks only

| Part Number | Description | Shipping Weight lb (kg) |
|---|--|-------------------------|
| 10"D (250 mm) Shelf, H x W - in (mm) | | |
| 12291-X01 | 2U x 17.25 (438.2), Supports 40 lb (18.1 kg) | 4 (1.8) |
| 15"D (380 mm) Shelf, H x W - in (mm) | | |
| 40074-X00 | 3U x 17.25 (438.2), Supports 50 lb (22.7 kg) | 6 (2.7) |

X=color: 1=Gray, 2=Computer Beige, 5=Clear, 7=Black, E=Glacier White



1U



Power Strip

Streamlined, durable steel body is fitted with bracket for mounting.

- 17"L (430 mm), uses 1U, black
- Circuit breaker, six or eight outlets, non-surge or surge-protected, 10'L (3 m) cord

| Part Number | AMP | Plug Type | Outlets | Surge Protected |
|-------------|-----|-------------|-----------|-----------------|
| 12816-701 | 15A | NEMA 5-15P | (8) 5-15R | No |
| 12816-702 | 15A | NEMA L5-15P | (8) 5-15R | No |
| 12816-703 | 15A | NEMA 5-15P | (6) 5-15R | Yes |
| 12816-704 | 15A | NEMA L5-15P | (6) 5-15R | Yes |
| 12816-705 | 20A | NEMA 5-20P | (8) 5-20R | No |
| 12816-706 | 20A | NEMA L5-20P | (8) 5-20R | No |
| 12816-707 | 20A | NEMA 5-20P | (6) 5-20R | Yes |
| 12816-708 | 20A | NEMA L5-20P | (6) 5-20R | Yes |

See Section 1 for additional shelf options.

See Section 7 for additional power options.



The cabinet ships in a flat pack and arrives in six partially assembled pieces for easy maneuvering and storage.



Standard Wall-Mount Cabinet

- Engineered solution designed for smaller equipment rooms, closets and remote locations
- Ships partially assembled in a compact flat pack and is easy to maneuver
- Cabinet chassis is vented on top and bottom
- Includes one pair of adjustable depth 19" EIA square-punched equipment mounting rails
- Offers a number of different door designs and colors
- Accessory filtered fan kits provide additional airflow (120V and 230V)
- Bonded construction facilitates grounding
- Wall-mounted equipment enclosure with lockable front door, electronic locks are available
- Provides support for 19"W (482.6 mm) EIA rack-mount equipment and shelves
- For indoor use only, in environmentally controlled areas, not harsh environments

Includes:

- Cabinet with hinged door
- Equipment mounting rails, one pair
- Equipment mounting hardware (25) M6 cage nuts and screws
- Assembly and installation hardware (includes M8 lag bolts)
- Load Capacity (varies with height):
 - 6U, 14.8"H (375 mm): 60 lb (27.2 kg)
 - 9U, 20.0"H (508 mm): 90 lb (40.8 kg)
 - 12U, 25.2"H (640 mm): 130 lb (58.9 kg)
- Certifications/Compliance:
 - EIA-310-E compliant equipment mounting rails
- Material:
 - Steel frame, rails and panels
 - Plastic seals and fingers
 - Tempered glass
- Construction:
 - Slot-and-hook/bolted frame; mounting rails bolt to frame
- Finish:
 - Epoxy-polyester hybrid powder coat paint

| Part Number | Door Style | Width | Depth | Width | Depth | Shipping Weight lb (kg) |
|-------------|------------------|-------------|--------------|--------------|------------|----------------------------|
| | | Usable Dims | Overall Dims | Overall Dims | | |
| 25500-7XX | Solid | 19"EIA | 13.75 (349) | 23.6 (600) | 19.7 (500) | 61 (27.7) |
| 25501-7XX | Tempered Glass | 19"EIA | 13.75 (349) | 23.6 (600) | 19.7 (500) | 62 (28.1) |
| 25502-7XX | Perforated Metal | 19"EIA | 13.75 (349) | 23.6 (600) | 19.7 (500) | 58 (26.3) |
| 25503-7XX | Solid | 19"EIA | 17.7 (449) | 23.6 (600) | 23.6 (600) | 67 (30.4) |
| 25504-7XX | Tempered Glass | 19"EIA | 17.7 (449) | 23.6 (600) | 23.6 (600) | 68 (30.8) |
| 25505-7XX | Perforated Metal | 19"EIA | 17.7 (449) | 23.6 (600) | 23.6 (600) | 64 (29.0) |

XX = Height, -X06= 6U, 14.8" (375 mm); -X09=9U, 20.0" (508 mm); -X12=12U, 25.2" (640 mm). Color listed is black, also available in E=Glacier White.
Shipping weights are for 12U cabinets.

Standard Wall-Mount Cabinet Accessories

Cable Lashing Bracket

Secures multiple cable bundles along the side of the cabinet. May be installed in front or behind the equipment mounting rail of on either side of the cabinet frame.

Ring Cable Manager

Organizes loose patch cords along the sides of the cabinet. May be installed on either side of the cabinet frame.

Finger Cable Manager

Plastic T-shaped fingers with openings alongside the equipment mounting rails to organize patch panels at each U space.

Rear Bracket Manager

Use to secure service loops at the back of the cabinet. Included with 6U cabinet to provide load support. May be installed at the top, bottom or both places on the rear cabinet panel.

Fan Kit

Provides additional airflow. Attaches over the vents on the top or bottom of cabinet, drawing air in and pressurizing the cabinet, which forces warm air out



25512-712



25514-712



25513-712

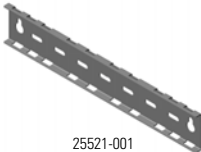

25521-001



25515-00X

| Part Number | Description | Shipping Weight lb (kg) |
|-------------|---|-------------------------|
| 25512-X12 | Cable Lashing Bracket, for 12U | 3 (1.4) |
| 25514-X12 | Ring Cable Manager, for 12U | 2 (0.9) |
| 25513-X12 | Finger Cable Manager, for 12U | 3 (1.4) |
| 25521-X01 | Rear Bracket Cable Manager, All heights | 3 (1.4) |
| 25515-001 | Fan Kit, 120V, 100CFM | 5 (2.3) |
| 25515-002 | Fan Kit, 230V, 100CFM | 5 (2.3) |

X = Color, -7XX= Black, -EXX=Glacier White. Cable Lashing Bracket, Ring Cable Manager and Finger Cable Manager also available in 6U (-X06) and 9U (-X09).



CUBE-IT Wall-Mount Cabinet

CUBE-IT Wall-Mount Cabinets feature highly functional elements to provide class-leading support and storage of ICT equipment. CUBE-IT Cabinets allow easy access to the front and rear of the cabinet, making it ideal for telecommunications rooms. Additionally, high airflow vent pattern and optional low-decibel, dual-fan kit provides equipment cooling without interfering noise. The new modern, sleek design with range of options make the cabinet ideal for use in office spaces, conference rooms, classrooms, or any public spaces where floor space is limited.

The swing-out, three-part design secures equipment while maintaining ease of access for serviceability. CUBE-IT Wall-Mount Cabinet is accessed by a keyed lock on the front door. Once unlocked, an internal latch is accessible just inside the front door on the main chassis. Simply turn the lever to release the main chassis from the wall to gain access to the rear of equipment.

The cabinet body delivers exceptional strength and rigidity. The UL 2416 Listed 300 lb (136 kg) load-rating provides tested support for heavier equipment. For an updated look with a robust, high-quality viewing panel, the front door has an optional tempered glass window. Use CUBE-IT Wall-Mount Cabinet to meet growing demands, Power over Ethernet (PoE) deployments, faster wireless and premise networks, audio and video equipment, security and monitoring equipment and smart building initiatives.

The removable top and bottom rear panels feature a rectangular cable pass-through knockout with optional brush seals, providing a larger opening for cables that can accept patch panels, making CUBE-IT a great solution for retrofit and existing infrastructure, or for use with factory-terminated structured cabling.

Features:

- Three-part, swing-out design allows access and service to the front and rear of equipment
- A single lock and key (CH751) on the front door provides access to the entire cabinet
- Rear panel includes 1" (25.4 mm) and 3" (76 mm) knockouts, and can accept 3/4" (19 mm) and 2.5" (63.5 mm) conduit. The 3" (76 mm) knockouts include edge-protection grommets
- Rear panel features cable tie and attachment points for accessory rack-mount brackets
- UL® 2416 Listed, 300 lb (136 kg) load rating
- Internal latch mechanism secures the rear panel; slim-profile does not impact cabling space
- Hinge design allows the installer to remove the rear panel for easier installation on the wall
- Cabinet body includes one pair of adjustable depth 19" EIA threaded equipment mounting rails
- Cable pass-through knockout with optional brush seal makes it ideal for retrofit installations
- Optional low-decibel (31 dB), dual-fan kit provides quiet operation while cooling equipment
- Factory-prepped bonding feature provides convenience and reduces installation time
- Ships fully assembled



CUBE-IT Wall-Mount Cabinet

- Attaches to the wall with included installation hardware
- Available in 12U, 19U and 26U heights, with solid metal or tempered glass door options
- All cabinet styles are 24"W (610 mm)
- Includes CH751 keyed locks

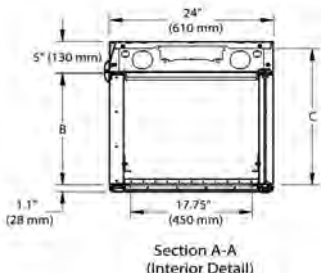
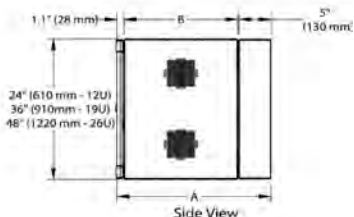
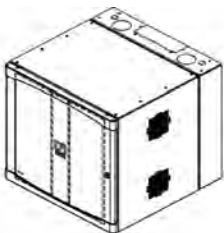

| Part Number | Cabinet Depth | Door Style | Shipping Weight lb (kg) |
|--|---------------|----------------|-------------------------|
| 24" H (610 mm) CUBE-IT Cabinet | | | |
| 11890-X24 | 18" (460 mm) | Solid | 90 (40.9) |
| 11901-X24 | 18" (460 mm) | Tempered Glass | 90 (40.9) |
| 11840-X24 | 24" (610 mm) | Solid | 101 (45.9) |
| 11900-X24 | 24" (610 mm) | Tempered Glass | 101 (45.9) |
| 11996-X24 | 30" (760 mm) | Solid | 112 (50.9) |
| 12419-X24 | 30" (760 mm) | Tempered Glass | 112 (50.9) |
| 36" H (910 mm) CUBE-IT Cabinet | | | |
| 11890-X36 | 18" (460 mm) | Solid | 114 (51.8) |
| 11901-X36 | 18" (460 mm) | Tempered Glass | 114 (51.8) |
| 11840-X36 | 24" (610 mm) | Solid | 128 (58.2) |
| 11900-X36 | 24" (610 mm) | Tempered Glass | 128 (58.2) |
| 11996-X36 | 30" (760 mm) | Solid | 142 (64.5) |
| 12419-X36 | 30" (760 mm) | Tempered Glass | 142 (64.5) |
| 48" H (1220 mm) CUBE-IT Cabinet | | | |
| 11890-X48 | 18" (460 mm) | Solid | 139 (63.2) |
| 11901-X48 | 18" (460 mm) | Tempered Glass | 139 (63.2) |
| 11840-X48 | 24" (610 mm) | Solid | 155 (70.5) |
| 11900-X48 | 24" (610 mm) | Tempered Glass | 155 (70.5) |
| 11996-X48 | 30" (760 mm) | Solid | 171 (77.7) |
| 12419-X48 | 30" (760 mm) | Tempered Glass | 171 (77.7) |

Note: X=Color; 7=Black and E=Glacier White

| Overall Depth (A) | Cabinet Body Depth (B) | Max. Equipment Depth (C) |
|-------------------|------------------------|--------------------------|
| 18" (460 mm) | 11.7" (297 mm) | 15.9" (403 mm) |
| 24" (610 mm) | 17.7" (449 mm) | 21.9" (556 mm) |
| 30" (760 mm) | 23.7" (602 mm) | 27.9" (708 mm) |

CUBE-iT Wall-Mount Cabinet Accessories

Cable Port Brush Kit

- Optional cover when rectangular knockout on the rear panel is removed
- Seals opening around cables with brush seal
- Sold in pairs



25190-000

Foot Kit

- For use on desktops or floor when not installed on a wall
- Pack of 4



13483-001

Equipment Mounting Rail Kit

- Use with equipment that needs front and rear support
- Sold in pairs
- Aluminum material

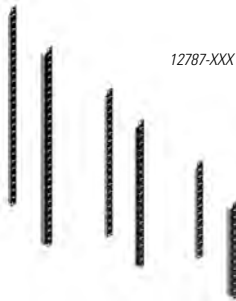

12787-XXX

| Part Number | Description | Shipping Weight lb (kg) |
|-------------|--|-------------------------|
| 25190-000 | Cable Port Brush Kit 0.8"H x 10.6"W x 2.9"D (20 mm x 268 mm x 74 mm) | 2 (0.9) |
| 13483-001 | Foot Kit | 2 (0.9) |
| 12787-524 | Equipment Mounting Rail Kit 12U; For 24"H (610 mm) cabinet | 4 (1.8) |
| 12787-536 | Equipment Mounting Rail Kit 19U; For 36"H (910 mm) cabinet | 6 (2.7) |
| 12787-548 | Equipment Mounting Rail Kit 26U; For 48"H (1220 mm) cabinet | 8 (3.6) |

Note: CUBE-iT Wall-Mount includes one pair of Equipment Mounting Rails

Metal D-Rings

A convenient and economical way to route, support and secure cables and jumper wires in terminal closets or wherever cable runs are required.

- Offered in three standard sizes
- Made from 1/8" x 1/2" (3.18 mm x 13 mm) hot-rolled steel strap with zinc plating to resist corrosion
- Ring edges are rolled to prevent nicks and scratches in the cable and wire insulation
- Mounting hardware not included

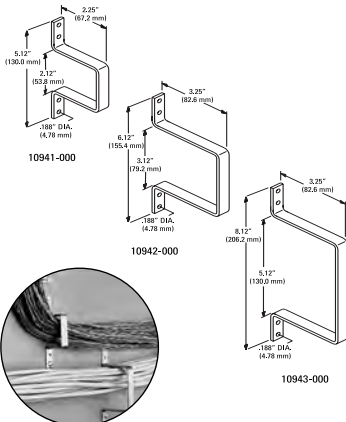

| Part Number | | Description | Shipping Weight lb (kg) |
|-------------|------------|--------------|-------------------------|
| Each | Box of 100 | | |
| 10941-000 | 10941-010 | Small Rings | 16 (7.3) |
| 10942-000 | 10942-010 | Medium Rings | 22 (10.0) |
| 10943-000 | 10943-010 | Large Rings | 24 (10.9) |

Shipping Weights are for Box of 100.



CUBE-IT Wall-Mount Floor-Supported Cabinet

The CUBE-IT Wall-Mount Floor-Supported Cabinet is designed to secure communications equipment for a cross connect. CUBE-IT Cabinets are copper- and fiber-ready and feature easy access to the front or the rear of the cabinet.

The swing-out, three-part design secures equipment while maintaining ease of access for serviceability. CUBE-IT Wall-Mount Floor-Supported Cabinet is accessed by a keyed lock on the front door. Once unlocked, an internal latch is accessible just inside the front door on the main chassis. Simply turn the lever to release the main chassis from the wall to gain access to the rear of equipment. Additionally, the cabinet is configurable for right or left swing.

The 5" D (130 mm) rear panel provides a space for terminating cables. The rear panel is prepunched along the top and bottom with conduit knockouts, allowing communications and power cables to be securely routed into the cabinet. Grommets are included to protect cables when conduit is not used. The interior of the rear panel has tie points for cables and attachment points for accessory equipment mounting brackets.

The main cabinet body includes two pairs of adjustable depth 19" EIA square-punched equipment mounting rails that can be used to support interconnect equipment and/or active components. The cabinet includes 50 units of Clik-Nut Hardware kit for quick, safe equipment mounting. Multiple fan options provide efficient equipment cooling.

Features:

- Three-part, swing-out design allows access and service to the front and rear of equipment. The cabinet body is supported on the floor by an attached wheeled base.
- A single lock and key on the front door provides access to the entire cabinet
- Cabinet body includes two pairs of adjustable depth 19" EIA square-punched equipment mounting rails and Clik-Nut Hardware Kit
- Rear panel includes 1" (25.4 mm) and 3" (76 mm) knockouts, and can accept 3/4" (19 mm) and 2.5" (63.5 mm) conduit. Edge-protection grommets are included for the 3" (76 mm) knockouts
- Rear panel features fixing points for cable slack management and attachment points for accessory rack-mount brackets
- Optional low-decibel (31 dB), dual-fan kit provides quiet operation while cooling equipment
- Factory-prepped bonding feature provides convenience and reduces installation time



CUBE-IT Wall-Mount Floor-Supported Cabinet

- Wall-mount, floor-supported enclosure with lockable front door and swing-out rear access to equipment
- EIA/ECA-310-E compliant
- 1000 pounds (453.6 kg) of equipment open or closed
- All cabinet styles are 27.3" W (693 mm)

| Part Number | Cabinet Depth | Door Style | Shipping Weight lb (kg) |
|---|---------------|----------------|-------------------------|
| 60" H (1520 mm) CUBE-IT Cabinets | | | |
| 13492-X60 | 24" (610 mm) | Solid | 248 (112.7) |
| 13493-X60 | 30" (760 mm) | Solid | 260 (118.2) |
| 13495-X60 | 24" (610 mm) | Tempered Glass | 278 (126.4) |
| 13496-X60 | 30" (760 mm) | Tempered Glass | 290 (131.8) |
| 72" H (1830 mm) CUBE-IT Cabinets | | | |
| 13492-X72 | 24" (610 mm) | Solid | 296 (134.5) |
| 13493-X72 | 30" (760 mm) | Solid | 309 (140.5) |
| 13495-X72 | 24" (610 mm) | Tempered Glass | 329 (149.5) |
| 13496-X72 | 30" (760 mm) | Tempered Glass | 342 (155.5) |

Note: X=Color; 7=Black and E=Glacier White

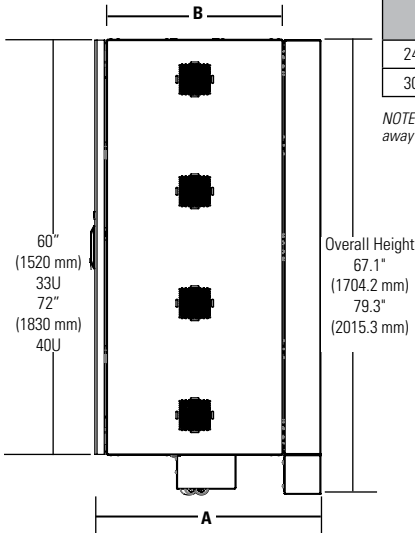

| Overall (A) | Cabinet Body (B) | Max. Rail-to-Rail Spacing | Max. Equipment Depth |
|----------------|------------------|---------------------------|----------------------|
| 24.9" (633 mm) | 18.1" (460 mm) | 16.7" (424 mm) | 22.2" (564 mm) |
| 30.9" (785 mm) | 24.1" (612 mm) | 22.7" (576 mm) | 28.2" (716 mm) |

NOTE: Maximum equipment depth denotes values that still allow the center chassis to swing away from rear panel.

Standard Fan and Filter Kit

- Pressurizes interior of the cabinet, forcing warm air out of open vents
- Assembly Includes 1 fan, 1 filter, and 1 vent cover
- Noise Level: 39 dB (measured at 3' (1 m) distance)
- Airflow: 115 CFM (170 CMH)
- 6'L (1.8 m) NEMA 5-15P/6-15P Power Cord within the cabinet. It attaches to the cabinet with standard #12-24 rack screws (Included in the ThinLine II Cabinet's hardware kit).



| Part Number | Description | Shipping Weight lb (kg) |
|-------------|--------------------------------------|-------------------------|
| 40972-001 | 115 Volt, 50/60 Hz, 5-15P power cord | 2 (0.8) |
| 40972-002 | 230 Volt, 50/60 Hz, 6-15P Power cord | 2 (0.8) |
| 40973-001 | Replacement Filter Kit, Pack of 5 | 2 (0.8) |

Low-Decibel Dual-Fan and Filter Kit

- Pressurizes interior of the cabinet, forcing warm air out of open vents
- Assembly Includes 2 fans and 2 filters
- Noise Level: 31 dB (measured at 3' (1 m) distance)
- Recommended placement on bottom right and left sides of the cabinet
- Airflow: 120 CFM (204 CMH)
- 6'L (1.8 m) NEMA 5-15P/6-15P Power Cord



| Part Number | Description | Shipping Weight lb (kg) |
|-------------|--------------------------------------|-------------------------|
| 40975-001 | 115 Volt, 50/60 Hz, 5-15P power cord | 2 (0.8) |
| 40975-002 | 230 Volt, 50/60 Hz, 6-15P Power cord | 2 (0.8) |
| 40973-001 | Replacement Filter Kit, Pack of 5 | 2 (0.8) |

Bonding Jumper Kit

- Provide common bonding from equipment rack or cabinet to halo conductor
- Available individually or in packages of 10
- Constructed of UL Listed components



| Part Number | Description | Shipping Weight lb (kg) |
|-------------|------------------------------------|-------------------------|
| 40159-009 | 9' (2.7 m) Bonding Jumper, 1 Each | 2 (0.9) |
| 40159-019 | 9' (2.7 m) Bonding Jumper, 10 Each | 20 (1.9) |



4U



7U



11U

Vertical Cabling Section

- Attaches to the outside edge of equipment mounting rails
- Openings align with rack-mount unit spaces on equipment mounting rails
- Sold in pairs
- Order additional kits as-needed per cable management requirements

| Part Number | Description | Shipping Weight lb (kg) |
|-------------|--------------------------------------|-------------------------|
| 40970-704 | 4U, 7"H x 0.5"D (178 mm x 13 mm) | 3 (1.4) |
| 40970-707 | 7U, 12.3"H x 0.5"D (311 mm x 13 mm) | 3 (1.4) |
| 40970-711 | 11U, 19.3"H x 0.5"D (489 mm x 13 mm) | 4 (1.8) |



CUBE-iT Wall-Mount
24", 36" & 48"



CUBE-iT Wall-Mount
Floor Supported
60" & 72"

Vertical Lashing Bracket

- Provides multiple lashing points for premise cables
- Attaches to center chassis with included hardware
- Adjustable front-to-rear

| Part Number | Description | Shipping Weight lb (kg) |
|---|-------------------------------|-------------------------|
| 40971-X24 | 24"H x 4"W (610 mm x 100 mm) | 4 (1.8) |
| 40971-X36 | 36"H x 4"W (910 mm x 100 mm) | 6 (2.7) |
| 40971-X48 | 48"H x 4"W (1220 mm x 100 mm) | 8 (3.6) |
| For Wall-Mount Floor Supported Cabinets | | |
| 40971-X60 | 60"H x 4"W (1520 mm x 100 mm) | 4 (1.8) |
| 40971-X72 | 72"H x 4"W (1820 mm x 100 mm) | 6 (2.7) |

Note: X=Color, 7=Black and E=Glacier White

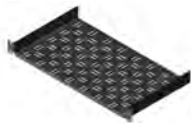

40974-X19



11837-X02



12803-701



13285-501



12820-XXX

CUBE-IT Cabinet Accessories

Rack Mount Shelf

- For use with small equipment such as modems, routers and fiber modules in 19" EIA racks
- 1U; Includes multiples tie-down points
- Supports up to 20 lb (9.1 kg) of equipment

Horizontal Wire Management Bar

- Attaches to the rear of the equipment mounting rails in CUBE-IT Cabinet
- Secure premise cables after termination on patch panels
- Includes mounting hardware and 12 cable ties

LED Light Kit

- Attaches to the bottom, top or side of CUBE-IT Cabinets
- Toggle switch, 4W LED light
- Detachable, 120 VAC with NEMA 1-15P Power Cord

90° Mounting Bracket

- Attaches to rear panel on CUBE-IT Cabinets
- Creates a 19" EIA x 2U vertical rack-mount space
- 2 brackets per kit, 3.9"H x 1"W x 4"D (99 mm x 25.4 mm x 101.6)

Power Strip

- Select straight or locking plug style
- 115 VAC; 15 Amp or 20 Amp
- 10'L (3 m) power cord and circuit breaker
- Includes (8) 5-20R outlets

Note: Surge-Protected options available.

| Part Number | Description | Shipping Weight lb (kg) |
|-------------|---|-------------------------|
| 40974-X19 | Rack-Mount Shelf, 1U x 19"W x 10"D (483 mm x 250 mm) | 4 (1.8) |
| 11837-701 | Wire Management Bar 1.5"H x 19.3"W x 3.7"D (38 mm x 490 mm x 94 mm) | 4 (1.8) |
| 11837-702 | Wire Management Bar 1.5"H x 19.3"W x 3.7"D (38 mm x 490 mm x 94 mm) | 4 (1.8) |
| 12803-701 | LED Light Kit, 4W, 120 Vac | 2 (0.9) |
| 13285-501 | 90° Mounting Bracket, (1) Pair, Clear | 3 (1.4) |
| 12820-701 | 15A Power Strip, NEMA 5-15P | 4 (1.8) |
| 12820-702 | 15A Power Strip, NEMA L5-15P | 4 (1.8) |
| 12820-705 | 20A Power Strip, NEMA 5-20P | 4 (1.8) |
| 12820-706 | 20A Power Strip, NEMA L5-20P | 4 (1.8) |

X=color: 7=Black, E=Glacier White



ThinLine II Wall-Mount Cabinet

The ThinLine II maximizes interior space using a distinctive equipment mounting rail system. Individual rails can be easily rotated for horizontal or vertical mounting and then bolted into place making patch panel punchdown easier. The cabinet can hold a server, switch, horizontal cable manager, patch panel, fiber service loop and fiber-optic patch panel — with room to accommodate additional mounting needs.

An easy-to-remove top panel slides in and out of position (without tools) using a spring button release. In addition, the 26" H (660 mm) cabinet can be mounted so that the removable "top" panel becomes a side panel.

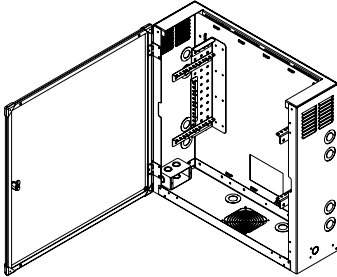

ThinLine II can hold a server, switch, horizontal cable manager, patch panel, fiber service loop and fiber-optic patch panel—with room to accommodate additional mounting needs.

A 4" x 6" (100 mm x 150 mm) opening in the rear of the cabinet and knockouts sized 3/4" and 1-1/2" allow cable entry and exit. Also features multiple cable tie-down points in rear panel.

- Door features rounded edges and corners and can be mounted to open from either right or left
- Removable top panel provides direct access to equipment without disturbing other devices
- Multiple sets of knockouts allow flexibility in cable organization
- Louvers and fan accessory provide ventilation
- Cabinet includes a 2" x 4" (50 mm x 100 mm) junction box to hold an optional surge-suppressed duplex outlet, eliminating the need for a power strip
- Made of steel
- Ships fully assembled with mounting hardware
- Static load rating is 100 lb (45.4 kg)

| Part Number | Description | Shipping Weight lb (kg) |
|-----------------------------------|--------------------------------------|-------------------------|
| 26" H (660 mm) ThinLine II | | |
| 13050-X11 | 26 x 26 x 5, 2U, (660 x 660 x 130) | 47 (21.3) |
| 13050-X12 | 26 x 26 x 8.5, 4U, (660 x 660 x 216) | 54 (24.5) |
| 13050-X13 | 26 x 26 x 12, 6U, (660 x 660 x 300) | 60 (27.2) |
| 36" H (910 mm) ThinLine II | | |
| 13050-X21 | 36 x 26 x 5, 2U, (910 x 660 x 130) | 60 (27.2) |
| 13050-X22 | 36 x 26 x 8.5, 4U, (910 x 660 x 216) | 68 (30.8) |
| 13050-X23 | 36 x 26 x 12, 6U, (910 x 660 x 300) | 76 (34.5) |

*X=*color: 1=Gray, 2=Computer Beige, 7=Black

Fiber Slack Manager Panel

The Fiber Slack Manager Panel provides both fiber slack management and a mounting surface for a small fiber manager or fiber-optic patch panel. Secured under the outermost mounting units, the panel takes up no mounting space within the cabinet. It attaches to the cabinet with standard #12-24 rack screws (Included in the ThinLine II Cabinet's hardware kit).



| Part Number | Description | Color | Shipping Weight lb (kg) |
|-------------|----------------|----------------|-------------------------|
| 12955-219 | 19" Rack-Mount | Computer Beige | 2 (0.9) |
| 12955-719 | 19" Rack-Mount | Black | 2 (0.9) |



Surge-Suppressed Duplex Receptacle

The cabinet can be easily configured with two surge-suppressed outlets, eliminating the need for a power strip. ThinLine II includes an electrical junction box that can be mounted on either side of the cabinet. A 1/2" or 3/4" knockout is provided.

| Part Number | Description | Shipping Weight lb (kg) |
|-------------|-----------------------|-------------------------|
| 12934-001 | Receptacle, 125V, 15A | 2 (0.9) |



13501-001

Intelligent Fan Kit

The ThinLine II Intelligent Fan Kit uses a solid state temperature control to vary fan speed from an ultra quiet low speed at low air temperature through increasingly higher speeds as temperature rises.

| Part Number | Description | Shipping Weight lb (kg) |
|-------------|--------------------------------|-------------------------|
| 13051-001 | 115 VAC, 60 Hz, 4U/6U Cabinets | 2 (0.9) |
| 13051-002 | 115 VAC, 60 Hz, 2U Cabinet | 2 (0.9) |

13051-001 Intelligent Fan Specifications:

| | |
|---|---|
| Minimum Fan Speed <i>(air temp 77° or less)</i> | Maximum Fan Speed <i>(air temp 104° or greater)</i> |
| 65 CFM (Free Air) | 120 CFM (Free Air) |
| 34 dB (Noise Level) | 51 dB (Noise Level) |

13051-002 Intelligent Fan Specifications:

| | |
|---|---|
| Minimum Fan Speed <i>(air temp 77° or less)</i> | Maximum Fan Speed <i>(air temp 113° or greater)</i> |
| 36 CFM (Free Air) | 49 CFM (Free Air) |
| 28 dB (Noise Level) | 33 dB (Noise Level) |

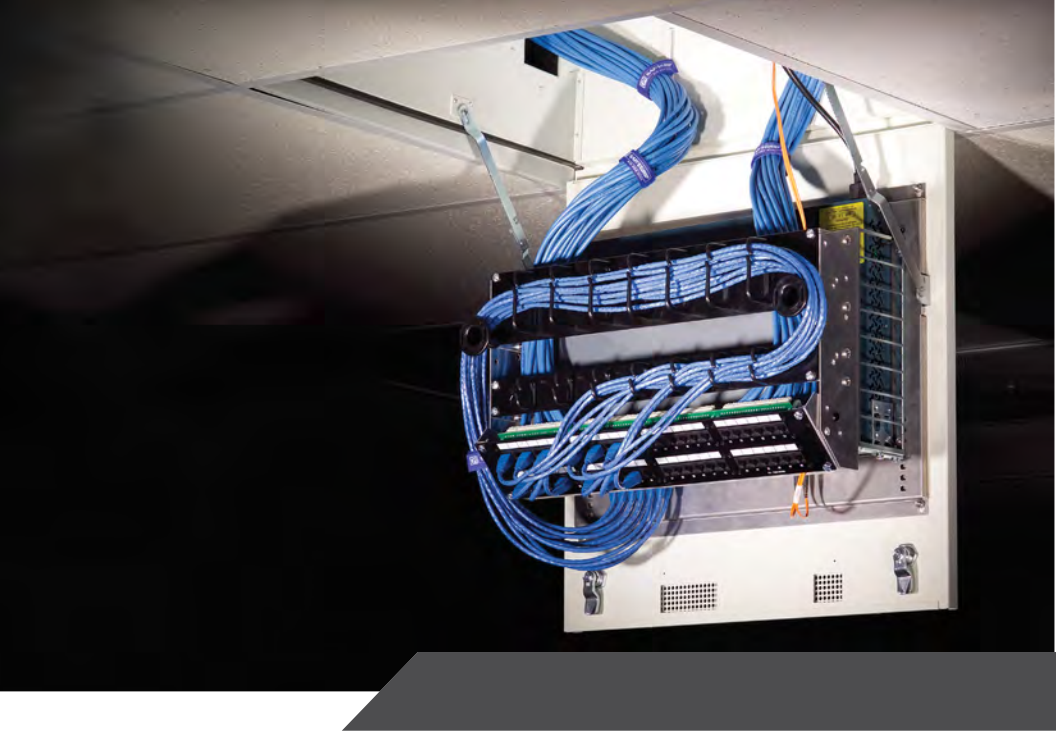

SECTION 11

ZONE CABLING & WIRELESS SYSTEMS

| | |
|--|-------|
| Zone Enclosures – Raised Floor | 11-4 |
| Zone Enclosures – Drop Ceiling | 11-6 |
| Zone Enclosures Service Parts | 11-9 |
| Wireless Enclosures – Drop Ceiling | 11-10 |
| Wireless Enclosures – Wall-Mounted | 11-12 |

ZONE CABLING & WIRELESS SYSTEMS

When it is time for a network to extend beyond the traditional telecommunications room, CPI Zone Cabling and Wireless Enclosures provide consolidation points to reduce the overall cost of adding or moving network cabling. CPI offers solutions that include standard-recognized zone cabling practices and several NEMA-rated models that can be used in nontraditional environments.

Where Can I Learn More?

To learn more about CPI's Zone Cabling and Wireless Enclosures, or to find additional part numbers not listed in this catalog, please visit our website, chatsworth.com

Related Tools:

Use these tools, under the Resources tab on chatsworth.com, to simplify your planning, selection, order and purchase of CPI Zone Cabling and Wireless Enclosures.

- Visio Shape
- CAD Blocks
- BIM Drawing
- MasterFormat Specs
- OSHPD Products

Your Notes Here:



Wireless Wall-Mount Enclosure

Telecommunication Enclosures For Zone Cabling & Wireless Applications

In traditional cabling models, cables extend from a centralized telecommunication room to each work area. Cable changes impact the entire length of cable between the central room and the work area and can be disruptive to workers within the workspace.

In zone cabling, floor space is divided into zones (typically the area between structural building columns), and an enclosure is placed near the center of the zone to house a consolidation point. Thus, only the cable between the consolidation point and work area is impacted when a network connection is changed, reducing the amount of material, labor and workspace disruption involved in the change.

Alternately, an active component (such as a switch) can be placed within the enclosure, essentially creating a "mini-telecommunication room" within the workspace. When fiber is routed into the enclosure, an easily scalable network is created via the active component. The customer's network is thus positioned to allow fiber to the desktop when desired.

Zone cabling is an ideal solution to support networked areas with high "churn" (such as rented commercial office space, data centers, laboratories, schools, hospitals, retail operations, warehouses and industrial environments) or for use in any building that does not have planned space for a telecommunication room.

Wireless networks eliminate the need for data cabling to each user and are the best solution in large, open areas, like classrooms and meeting rooms. Wireless networks can supplement, overlay or replace traditional networks. The key to an effective wireless network is the positioning of the wireless access point to provide maximum coverage in the workspace. Once locations are defined, wireless enclosures create a secure space for the network connection and the wireless access point.

CPI offers Zone Cabling and Wireless Enclosures for use in drop ceilings, access floors and on walls. Also, a special series of wall-mount enclosures made of fiberglass are NEMA rated for use in dusty or wet environments, such as outdoors, in a warehouse or in a light industrial site (not submerged or in hazardous locations). Product applications and model information are given on the following pages.

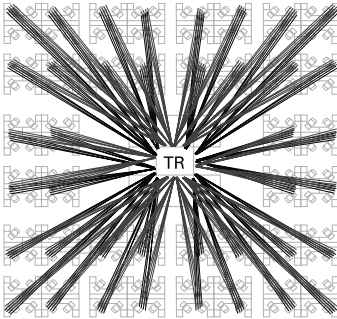

Traditional, Home Run Wiring

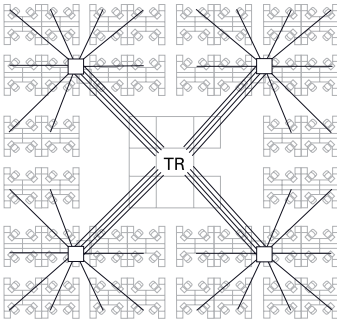

Zone Cabling

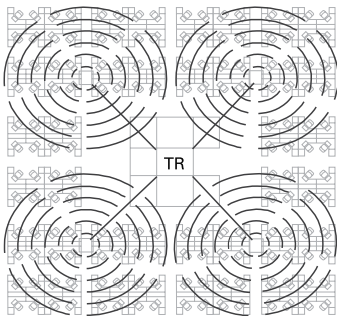

Wireless



Raised Floor Enclosures

Raised Floor Enclosures fit under a single 2' x 2' access floor tile. Most models use the access floor tile as a "lid." Enclosures are UL Listed, suitable for low voltage and active applications and for use in air handling spaces.

A variety of sizes are available to match floor height. Most models include brackets for attachment to access floor support pedestals. Enclosures include threaded equipment mounting rails and have multiple, edge-protected cable access ports with foam sealing kits. All enclosures are finished clear.

In enclosures designed for use in low height floors, two facing pairs of pivoting equipment mounting rails are used to provide easy access to the front and rear of the patch panel. In deeper enclosures, rails that are parallel to the floor provide higher consolidation point capacity. There is also a model with a lift out tray that can support active components. Order #12-24 equipment mounting screws (P/N 40605-001) separately.

Raised Floor Enclosures For Patch Panels

These enclosures use the access floor tile as a "lid." (All models, except A0222-RF, include access floor installation brackets.)

- A0222-RF features four cable access ports 6" x 3/4" (152 mm x 19 mm); 19" EIA threaded equipment mounting rails "pivoting"
- A0422-RF features four cable access ports 6" x 3/4" (152 mm x 19 mm); 19" EIA threaded equipment mounting rails "pivoting"
- A0622-RF features four cable access ports 6-3/4" x 2" (171 mm x 50 mm); 19" EIA threaded equipment mounting rails "pivoting"
- A0822-RF features four cable access ports 6-3/4" x 2" (171 mm x 50 mm); 19" EIA threaded equipment mounting rails "pivoting"
- 13772-001 features larger cable openings for Cat 6a cables; two ports 14-3/4" x 3-1/4" (374 mm x 82 mm) and two ports 6-1/4" x 7" (158.8 mm x 180 mm); 19" EIA threaded equipment mounting rails "pivoting"
- A1422-RF features four cable access ports 9-3/4" x 2-3/4" (247 mm x 69 mm); 19" EIA threaded equipment mounting rails "fixed"
- 13772-002 features larger cable openings for Cat 6a cables; six ports 14-3/4" x 3-1/4" (374 mm x 82 mm); 19" EIA threaded equipment mounting rails "pivoting"



A0822-RF



A1422-RF

| Part Number | Description Depth in (mm) | Shipping Weight lb (kg) |
|-------------|--|-------------------------------|
| A0222-RF | 1U+1U Enclosure for 2 (50) Floor | 10 (4.5) |
| A0422-RF | 1U+1U Enclosure for 4 (100) Floor | 10 (4.5) |
| A0622-RF | 2U+2U Enclosure for 6 (150) Floor | 23 (10.4) |
| A0822-RF | 4U+4U Enclosure for 8 (200) Floor | 23 (10.4) |
| 13772-001 | 4U+4U Enclosure for 8 (200) Floor, Large Ports | 25 (11.3) |
| A1422-RF | 11U Enclosure for 14 (360) Floor | 30 (13.6) |
| 13772-002 | 4U+4U Enclosure for 14 (360) Floor, Large Ports | 30 (13.6) |



A0822-RF-F

Raised Floor Enclosure For Fiber

Prepare your data center for future changes by prewiring it with fiber connections located under an access floor.

- Fits under a single 2' x 2' access floor tile
- A0822-RF-F features two 7" x 2" (180 mm x 50 mm) cable access ports and 19" EIA threaded equipment mounting rails with 4U of rack-mount unit space
- A1422-RF-F features two 10" x 2-1/2" cable access ports and 19" EIA threaded equipment mounting rails with 6U of U space
- Equipment mounting rails can be centered or offset in the enclosure to accommodate angled patch panels or longer electronics
- Cable tie points simplify cable management
- Includes (4) access floor support brackets

| Part Number | Description Depth in (mm) | Shipping Weight lb (kg) |
|-------------|---------------------------------------|-------------------------|
| A0822-RF-F | 4U Fiber Enclosure for 9 (230) Floor | 30 (13.6) |
| A1422-RF-F | 6U Fiber Enclosure for 14 (356) Floor | 30 (13.6) |



A1411-RF-HR

Raised Floor Enclosure For Active Component

Features a lift-out tray for 2U x 10-1/4"D (260.4 mm) of active components and 5U (divided 2U - 1U - 2U) for passive connectivity.

- Includes a junction box for a duplex power outlet
- Includes fan to remove heat generated by active components

| Part Number | Description Depth in (mm) | Shipping Weight lb (kg) |
|-------------|---------------------------------|-------------------------|
| A1411-RF-HR | 7U Enclosure for 14 (360) Floor | 30 (13.6) |



A0802-RF-DI

Raised Floor Enclosure With Locking Cover For Patch Panels

"Drop-In" enclosure measures 21-1/4" x 22-1/4" (539.8 mm x 565.2 mm) and includes a locking cover for use completely below access floor tiles. Installation only requires the removal of one floor tile.

- Features pivoting mounting rails similar to models above and is perfect for existing data centers

| Part Number | Description Depth in (mm) | Shipping Weight lb (kg) |
|-------------|-----------------------------------|-------------------------|
| A0802-RF-DI | 4U+4U Enclosure for 9 (230) Floor | 25 (11.3) |

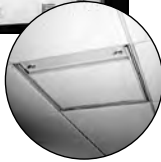

Ceiling Enclosures

Ceiling Enclosures fit within a single 2' x 2' or 2' x 4' space, replacing a standard acoustical ceiling tile. The enclosure's face and interior are painted white and have recessed panels to support a ceiling tile, so that they blend with the drop ceiling. A fully hinged door panel with latch closures supports equipment. The door opens downward so that equipment is facing the service technician. Three door styles are available to support wiring blocks, patch panels or active components. Door locks are available as an accessory.

Ceiling Enclosures are UL Listed, suitable for low voltage and active applications and for use in air handling spaces.

- 2' x 2' enclosures support 70 lb (31.8 kg) of cables and equipment and 20 lb (9.1 kg) on the access door
- 2' x 4' enclosures support 80 lb (36.3 kg) of cables and equipment and 50 lb (22.7 kg) on the pneumatic assisted access door
- Enclosures fit in 12"H (300 mm) drop ceilings and attach to building structure with four or six 3/8" threaded rods (ordered separately)
- Includes two or four edge-protected cable access ports with fire-rated foam sealing kits



A1222-HR

Ceiling Enclosure For Hubs, Switches And Patch Panels

Telecommunication enclosure supports a combination of active components and patch panels or other panel-mount termination hardware. Enclosures include a junction box for power and a fan to remove heat generated by active components.

- A1222-HR provides 5U for patch panels and 2U x 15"D (380 mm) for active equipment; equipment mounts on the door
- 13812-001 provides larger cable openings for Cat 6a; one 3-1/4" x 14-3/4" (82.6 mm x 374.7 mm) and one 6-1/4" x 6-7/8" (158.8 mm x 174.6 mm)
- A1024-HR provides 5U for patch panels and 2U x 15"D (380 mm) for active equipment; equipment mounts on the door
- A1224-HR provides a total of 10U with (3) brackets sized 4U - 2U - 4U to support a combination of patch panels and 15"D (380 mm) or less active equipment; brackets may be mounted on the door or the back of the enclosure
- Order #12-24 equipment mounting screws separately

| Part Number | Description | Shipping Weight lb (kg) |
|-------------|--|-------------------------|
| A1222-HR | 2' x 2' Ceiling Enclosure | 39 (17.7) |
| 13812-001 | 2' x 2' Ceiling Enclosure, Large Ports | 40 (18.1) |
| A1024-HR | 2' x 4' Ceiling Enclosure | 47 (21.4) |
| A1224-HR | 2' x 4' Ceiling Enclosure | 45 (20.4) |



A1222-PP



13813-001

Ceiling Enclosure For Patch Panels

Secure a consolidation point using 19" patch panels or other panel-mount termination hardware.

- A1222-PP provides a total of 5U with (3) brackets sized 2U - 1U - 2U; brackets mount on the door
- 13812-002 provides larger cable openings for Cat 6a; one 3-1/4" x 14-3/4" (82.6 mm x 374.7 mm) and one 6-1/4" x 6-7/8" (158.8 mm x 174.6 mm)
- A1024-PP provides a total of 5U with (3) brackets sized 2U - 1U - 2U; brackets mount on the door
- A1224-PP provides a total of 10U with (3) brackets sized 4U - 2U - 4U; brackets may be mounted on the door or the back of the enclosure
- Order #12-24 equipment mounting screws separately

| Part Number | Description Depth in (mm) | Shipping Weight lb (kg) |
|-------------|--|-------------------------|
| A1222-PP | 2' x 2' Ceiling Enclosure | 38 (17.2) |
| 13812-002 | 2' x 2' Ceiling Enclosure, Large Ports | 39 (17.7) |
| A1024-PP | 2' x 4' Ceiling Enclosure | 43 (19.6) |
| A1224-PP | 2' x 4' Ceiling Enclosure | 45 (20.4) |
| 13813-001 | Ceiling Enclosure Fan Kit & Junction Box | 3 (1.4) |

Fan Kit & Junction Box, included with 13812-001, can be installed on either 13812-002 or 13812-003 to better support active components.



A1224-LP

Ceiling Enclosure For Wiring Blocks

Secure a consolidation point using wiring blocks. Enclosures include removable equipment mounting plates that can be match drilled to accommodate a wide variety of wiring blocks.

- A1222-LP has (1) mounting plate, size 13-3/4"W x 19-1/2"L (349 mm x 495 mm) for (2) 300-pair 110D (without legs) style blocks or (1) 300-pair 110A (with legs) style blocks
- 13812-003 provides larger cable openings for Cat 6a; one 3-1/4" x 14-3/4" (82.6 mm x 374.7 mm) and one 6-1/4" x 6-7/8" (158.8 mm x 174.6 mm)
- A1024-LP has (1) mounting plate, 16"W x 22"L (406 mm x 559 mm) for (2) 300-pair 110A (with legs) style blocks
- A1224-LP has (2) mounting plates, size 13-3/4"W x 19-1/2"L (349 mm x 495 mm) for (4) 300-pair 110D (without legs) style blocks or (2) 300-pair 110A (with legs) style blocks

| Part Number | Description Depth in (mm) | Shipping Weight lb (kg) |
|-------------|--|-------------------------|
| A1222-LP | 2' x 2' Ceiling Enclosure | 38 (17.2) |
| 13812-003 | 2' x 2' Ceiling Enclosure, Large Ports | 39 (17.7) |
| A1024-LP | 2' x 4' Ceiling Enclosure | 43 (19.6) |
| A1224-LP | 2' x 4' Ceiling Enclosure | 45 (20.4) |



Basic Consolidation Enclosures

Basic Consolidation Enclosures (BCE) provide a low-cost, low-density consolidation point for telecommunication cabling. Both Ported (-P) and Non-Ported (-N) enclosures can be configured to be used either above the drop ceiling or below an access floor. All Ported versions (-P) come with a fire-rated foam sealing kit, making them suitable for air handling spaces. Basic Consolidation Enclosures are UL Listed (2043), plenum rated and come with a sealed door and a clear aluminum finish.



BCE-6-P

BCE-6-P

BCE-6-P measures 14"W x 6"D x 20"L (360 mm x 150 mm x 510 mm) and includes installation brackets for attachment to building structure with 3/8" threaded rods. (Equipment mounting brackets not included.)

| Part Number | Description | Shipping Weight lb (kg) |
|-------------|------------------|-------------------------|
| BCE-6-P | 2-Port Enclosure | 7 (3.2) |



BCE-24-P

BCE-24-P/N

BCE-24-P/N measures 14"W x 3"D x 20"L (360 mm x 80 mm x 510 mm). It includes rotating threaded interior mounting brackets for 1U of 19"W patch panel. Order #12-24 equipment mounting screws separately.

| Part Number | Description | Shipping Weight lb (kg) |
|-------------|-------------------------|-------------------------|
| BCE-24-P | 1U 2-Port Enclosure | 7 (3.2) |
| BCE-24-N | 1U Non-Ported Enclosure | 7 (3.2) |



BCE-48-P

BCE-48-P/N

BCE-48-P/N measures 14"W x 6"D x 20"L (360 mm x 150 mm x 510 mm). It includes rotating threaded interior mounting brackets for 2U of 19"W patch panels. Order #12-24 equipment mounting screws separately.

| Part Number | Description | Shipping Weight lb (kg) |
|-------------|-------------------------|-------------------------|
| BCE-48-P | 2U 2-Port Enclosure | 12 (5.4) |
| BCE-48-N | 2U Non-Ported Enclosure | 12 (5.4) |

Zone Enclosure Service Parts

CPI provides a variety of replacement parts for zone cabling enclosures. Chrome Lock Kits and Spare Keys enhance security of the Ceiling Enclosure, replacing existing turn locks. Mounting Brackets ensure weight of Raised Floor Enclosure is fully supported.



Spare Keys

Chrome Lock Kit

Chrome Lock Kits/Spare Keys

Optional locks provide additional security for all standard ceiling enclosures. Includes two locks and two keys.

| Part Number | Description |
|-----------------|------------------|
| Chrome Lock Kit | Lock Kit, Pair |
| Spare Keys | Spare Keys, Pair |



RF-BRACKET

Raised Floor Mounting Brackets

Additional brackets used to support Raised Floor Enclosures from access floor support pedestals.

| Part Number | Description |
|-------------|---------------------------|
| RF-BRACKET | Mounting Brackets, 4 each |

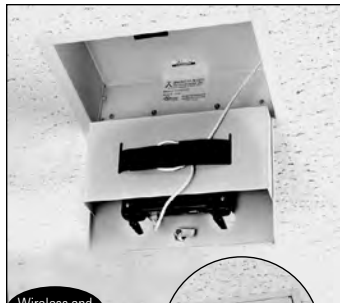

Wireless and Fiber Ready



- AAT-CAP-00
- AAT-CAP-UNI
- AAT-CAP-11
- AAT-CA-P-12
- AAT-CAP-1232
- AAT-CAP-1242
- AAT-CAP



AAT-CAP-1232-KIT

Ceiling-Mounted Wireless Access Point Enclosures

Ceiling Enclosures create a permanent location for various wireless access points or bridges within drop ceilings. Equipment is supported on the access door. Most access doors are pre-punched with openings for antennas. Ceiling Enclosures include support brackets for use with 2" ceiling "grids." AAT-CAP features interchangeable door-mounted faceplates with mounting brackets for equipment. Universal Faceplate accepts access points up to 2"H x 10"W x 8"D (50 mm x 250 mm x 200 mm) with antenna(s) up to 10.5" (267 mm) apart. Enclosure is finished in white.

| Part Number | Description W x D x L | Shipping Weight lb (kg) |
|---|---|----------------------------|
| Wireless Ceiling Enclosures Without Faceplates | | |
| AAT-CAP | 12 x 10 x 14.5 (305 x 254 x 368) | 8 (3.6) |
| AAT-CAP-10-P | 12 x 13 x 14.5 (305 x 330 x 368) with junction box | 9 (4.1) |
| AAT-CAP-S | 12 x 5 x 14.5 (305 x 127 x 368) | 8 (3.6) |
| Faceplates For Wireless Enclosures | | |
| AAT-CAP-00 | Blank (Solid) Faceplate | 3 (1.4) |
| AAT-CAP-UNI | Universal Faceplate | 3 (1.4) |
| AAT-CAP-11 | For Cisco® Aironet® 1100 | 3 (1.4) |
| AAT-CAP-12 | For Cisco® Aironet® 1200 | 3 (1.4) |
| AAT-CAP-1232 | For Cisco® Aironet® 1232 | 3 (1.4) |
| AAT-CAP-1242 | For Cisco® Aironet® 1242 | 3 (1.4) |
| AAT-CAP Enclosures, 10"D (250 mm), With Faceplates | | |
| AAT-CAP-00-KIT | Blank (Solid) Faceplate | 10 (4.5) |
| AAT-CAP-UNI-KIT | Universal Faceplate | 10 (4.5) |
| AAT-CAP-11-KIT | Cisco® 1100 Faceplate | 10 (4.5) |
| AAT-CAP-12-KIT | Cisco® 1200 Faceplate | 10 (4.5) |
| AAT-CAP-1232-KIT | Cisco® 1232 Faceplate | 10 (4.5) |
| AAT-CAP-1242-KIT | Cisco® 1242 Faceplate | 10 (4.5) |
| Additional Kits | | |
| AAT-CAP-S-00-KIT | Blank (Solid) Faceplate | 9 (4.1) |
| AAT-CAP-S-UNI-KIT | Universal Faceplate | 9 (4.1) |
| AAT-CAP-S-12-KIT | Cisco® 1200 Faceplate | 9 (4.1) |
| AAT-CAP-S-1232-KIT | Cisco® 1232 Faceplate | 9 (4.1) |
| AAT-CAP-S-1242-KIT | Cisco® 1242 Faceplate | 9 (4.1) |

Note: AAT-CAP-11 may only be used with AAT-CAP.



13833-001



WA064-CAP

Ceiling-Mounted Wireless Enclosure

Ceiling Enclosures create a secure and permanent location for various wireless access points or bridges within drop ceilings. Equipment is supported on the access door. Enclosures are finished in Computer Beige.

| Part Number | Description H x W x D in (mm) | Shipping Weight lb (kg) |
|-------------|---|-------------------------------|
| 13833-001 | 15.5 x 5 x 16.5 (394 x 127 x 419) Optimized for Cisco® 1250 | 10 (4.5) |
| WA064-CAP | 10 x 4 x 12.75 (254 x 102 x 324) Optimized for Cisco® Aironet® 350 | 5 (2.3) |

Wireless and
Fiber Ready

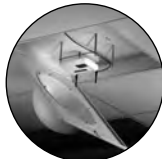

Dome Wireless Enclosure

The AAT-ACE-DOME replaces a single drop ceiling tile to hide wireless access points in open office spaces. The dome is mounted on a fully hinged locking door, providing easy access to equipment and cables for authorized technicians only.

- (1) 3/4"H x 3"W (19.1 mm x 80 mm) edge-protected cable access port with approved foam sealing kit
- Includes two sets of standoffs to adjust height of back plate within dome
- Enclosure: 23-3/4"W x 3"D x 23-3/4"L (603.3 mm x 80 mm x 603.3 mm)
- Dome: 6-1/2"H (165 mm), 14" Diameter (360 mm)
- Dome is large enough to accommodate most access points, including Cisco's large 1250 series AP
- Product Weight: 10.5 lb (4.76 kg)
- Removable mounting plate is 8 7/8"W x 6-7/8"L (225.43 mm x 174.63 mm)
- Customer must provide (4) 3/8" threaded rods and installation hardware
- Enclosure and dome are finished in Computer Beige.

| Part Number | Description H x W x D in (mm) | Shipping Weight lb (kg) |
|--------------|--|-------------------------------|
| AAT-ACE-DOME | 23.75 x 3 x 23.75 (603 x 80 x 603) Domed Wireless Enclosure | 21 (9.5) |



Wireless and Fiber Ready



Wireless Wall-Mount Enclosure

Wall-mounted access points provide better wireless coverage in some environments. This enclosure is for interior use and provides a secure and permanent wall-mounted location for various wireless access points and bridges.

- Optimized for Cisco® Aironet® 350
- Enclosure is finished in in Computer Beige
- UL Listed

| Part Number | Description H x W x D in (mm) | Shipping Weight lb (kg) |
|-------------|-------------------------------------|----------------------------|
| WA064-WAP | 11 x 8 x 3 (200 x 280 x 80) | 9 (4.1) |

NEMA Rated



NEMA-Rated Wireless Wall-Mount Enclosure

Wall-mounted wireless access point enclosure designed for warehouse, manufacturing, light industrial and exterior use. Single door is attached with a continuous steel hinge and secured by padlock through a stainless steel padlock hasp. A gasket seals the interior at closure.

- Enclosure is completely sealed; drill cable entry holes to fit application
- Enclosure: Fiberglass reinforced polyester, gray
- Enclosure: 11-1/2"H x 9-1/2"W x 4-1/2"D (292 mm x 241 mm x 114 mm)
- Product Weight: 5 lb (2.3 kg); Interior of the enclosure is 3"D (80 mm)
- Maximum equipment size is 9" x 7" x 3" (230 mm x 180 mm x 80 mm)
- Customer must provide installation and cable access hardware
- NEMA 1, 2, 3, 3R, 4, 4X, 12 and 13

| Part Number | Description H x W x D in (mm) | Shipping Weight lb (kg) |
|-------------|-------------------------------------|----------------------------|
| AAT-MWME-P | 11.5 x 9.5 x 4.5 (292 x 241 x 114) | 6 (2.7) |

NEMA Rated



Large NEMA-Rated Wireless Wall-Mount Enclosure

Designed for warehouse, manufacturing, light industrial and exterior use. Single front door is attached with a continuous steel hinge and secured by padlock through a stainless steel padlock hasp. A gasket seals the interior at closure.

- Enclosure is completely sealed; drill cable entry holes to fit application
- Removable mounting plate for wireless transmitters
- Enclosure: Fiberglass reinforced polyester, gray
- Product Weight: 7.5 lb (3.4 kg)
- The interior of the enclosure is 5"D (130 mm)
- Maximum equipment size: 13.5" x 11.5" x 5" (343 mm x 292 mm x 130 mm)
- Customer must provide installation and cable access hardware
- NEMA 1, 2, 3, 3R, 4, 4X, 12 and 13

| Part Number | Description H x W x D in (mm) | Shipping Weight lb (kg) |
|-------------|-------------------------------------|----------------------------|
| AAT-WME-P | 15.5 x 13.5 x 6 (394 x 343 x 150) | 11 (5.0) |

Wireless and
Fiber ReadyNEMA
Rated

Large NEMA-Rated Wireless Wall-Mount Enclosure With Window

The AAT-WMESG-P is for warehouse, manufacturing, light industrial and exterior use. A single front door provides access to equipment. The door is attached with a continuous steel hinge and secured by padlock through a stainless steel padlock hasp. A gasket seals the interior at closure. Large window provides viewing of equipment.

- Enclosure is completely sealed; customer drills cable entry holes to fit application
- Removable mounting plate for wireless transmitters
- Enclosure: Fiberglass reinforced polyester, gray
- Product Weight: 7.5 lb (3.4 kg)
- The interior of the enclosure is 5"D (130 mm)
- Maximum equipment size: 13.5" x 11.5" x 5" (343 mm x 292 mm x 130 mm)
- NEMA 1, 2, 3, 3R, 4, 4X, 12 and 13

| Part Number | Description H x W x D in (mm) | Shipping Weight lb (kg) |
|-------------|--|----------------------------|
| AAT-WMESG-P | 15.5 x 13.5 x 6 (394 x 343 x 150) Large Enclosure with Window | 11 (5.0) |



Zone Cabling, Wall-Mount Enclosure

The Wall-Mount Enclosure measures 24"H x 42"W x 7.5"D (610 mm x 1070 mm x 191 mm). Includes mounting positions for passive and active equipment, a junction box and a fan to remove heat generated by active components. Mounting positions include space for a single 100 pair 110-style termination block, a single 6-port fiber optic adapter panel, two 2U x 19" spaces for patch panels or other panel mount termination hardware and one 3U x 19" space for active components up to 18"D (460 mm).

The enclosure is pre-punched with knockouts for 1/2" or 1-1/2" electrical conduit for cables and has an insulated, locking, fully-hinged double door to reduce noise and provide security.

- Enclosure is finished in beige

| Part Number | Description H x W x D in (mm) | Shipping Weight lb (kg) |
|-------------|-------------------------------------|----------------------------|
| AAT-AWM-H | 24 x 42 x 7.5 (610 x 1070 x 191) | 76 (34.4) |



SECTION 12

INDEX

| | |
|-------------------|------|
| Part Number..... | 12-3 |
| Alphabetical..... | 12-9 |

INDEX

CPI New Products and Product Enhancements

Cabinet & Aisle Containment Systems section updates:

- RFID Electronic Locking System Page 1-9
- Patented Air Dam Kit Page 1-13

Cable Management Products section updates:

- Patented Motive® Cable Manager Page 2-3

Cable Runway & Tray Products section updates:

- Patented Tool-less Pathway Dividers Page 3-5
- PEMSA® Rejiband® Wire Mesh Cable Tray System Page 3-30
- PEMSA® Rejiband® Wire Mesh Cable Tray System Support Accessories Page 3-32

Environmental Monitoring & Security Systems section updates:

- eConnect® RFID Electronic Lock Kit Page 4-10
- Networked RFID Electronic Lock Kit Page 4-11
- Security System Electronic Lock Kit Page 4-11

Industrial Enclosure Systems section updates:

- RMR® Enclosures, New Stainless Steel Option:
 - RMR Floor-Mount Enclosures Page 6-20
 - RMR Free-Standing Enclosures Page 6-23
 - RMR Standard Wall-Mount Enclosures Page 6-28
- RMR Flange-Mount, Disconnect, Floor-Mount Enclosures Page 6-32
- RMR Flange-Mount, Disconnect, Free-Standing Enclosures Page 6-34
- RMR Flange-Mount, Disconnect, Wall-Mount Enclosures Page 6-36

Power Management Products section updates:

- Next-Generation eConnect® PDUs:
 - eConnect PDUs COcomparison Page 7-3
 - Basic eConnect PDU Page 7-5
 - Metered eConnect PDU Page 7-8
 - Monitored eConnect PDU Page 7-11
 - Monitored Pro eConnect PDU Page 7-14
 - Switched eConnect PDU Page 7-17
 - Switched Pro eConnect PDU Page 7-20
- RFID Electronic Locking Kits Page 7-25

Seismic Protection Systems section updates:

- Patented Air Dam Kit Page 9-12

| Part # | Page # | Description | Part # | Page # | Description |
|--------|-------------|----------------------------------|--------|--------|----------------------------------|
| 02004 | 3-29 | Hex Cap Bolts | 11294 | 8-19 | Low Profile Shelf |
| 02006 | 3-29 | Hex Cap Bolts | 11298 | 3-11 | Heavy-Duty Junction-Splice Kit |
| 02007 | 3-29 | Hex Lag Screw | 11299 | 3-11 | Heavy-Duty Butt-Splice Kit |
| 03001 | 3-28 | Hex Nuts | 11301 | 3-11 | Butt-Splice Kit |
| 03003 | 3-23 | Slip-On Lock Nut | 11302 | 3-12 | Junction-Splice Kit |
| 04002 | 3-28 | Washer, Type A Plain | 11308 | 3-19 | J-Bolt Kit |
| 04003 | 3-28 | Split Lock Washers | 11309 | 3-20 | Foot Kit |
| 08009 | 5-8 | One Mounting Hole Terminal Block | 11310 | 3-20 | Threaded Ceiling Kit |
| 10001 | 2-34, 5-10 | Stand-Off Tie Bracket | 11312 | 3-18 | Triangular Support Bracket |
| 10175 | 8-29 | Universal Dolly Wheels | 11313 | 3-13 | 45° Runway Splice Kit |
| 10250 | 3-3 | Universal Cable Runway | 11314 | 3-13 | 90° Runway Splice Kit |
| 10375 | 8-27 | Top Angle | 11359 | 8-20 | Low-Profile Vented Shelf |
| 10473 | 8-27, 9-7 | Heavy Duty Top Angle | 11374 | 2-25 | Vertical Cabling Section, Wide |
| 10487 | 3-14 | Butt-Swivel Splice Kit | 11406 | 3-23 | Ceiling Support Bracket |
| 10488 | 3-14 | Junction Swivel Splice Kit | 11408 | 3-24 | Runway Support Brackets |
| 10489 | 3-14 | Vertical Swivel Splice Kit | 11415 | 8-21 | Sliding Shelf |
| 10506 | 3-17 | Cable Runway Elevation Kit | 11421 | 3-19 | Wall Angle Support Kit |
| 10557 | 3-23 | Threaded Rod I-Beam | 11430 | 3-27 | J Bolts |
| 10559 | 2-34, 5-10 | Stand-Off Tie Bracket | 11440 | 3-22 | Threaded Drop Rods |
| 10562 | 9-6 | Universal Earthquake Bracing Kit | 11487 | 8-24 | Monitor Shelf |
| 10565 | 8-29 | Rack Extension Kit | 11521 | 8-33 | Hinged Panel Mounting Bracket |
| 10587 | 1-35 | Rail Adapter Kit | 11522 | 8-33 | Hinged Panel Mounting Bracket |
| 10595 | 3-15 | Channel-To-Rack Mtg Plate, 3" | 11523 | 8-33 | Hinged Panel Mounting Bracket |
| 10605 | 5-8, 8-26 | Rack Base Insulator Kit | 11524 | 8-33 | Hinged Panel Mounting Bracket |
| 10607 | 3-24 | Slotted Support Bracket | 11525 | 8-33 | Hinged Panel Mounting Bracket |
| 10608 | 3-20 | Vertical Wall Brackets | 11546 | 8-25 | Keyboard Tray, 19" Full Size |
| 10610 | 5-5 | Horizontal Rack Busbar | 11554 | 8-29 | Rack Standard Rollers |
| 10616 | 3-13 | Adjustable Runway Splice Kit | 11564 | 2-32 | Horizontal Ring Panel, Large |
| 10622 | 5-4 | Standard Busbars | 11583 | 10-6 | Flush-Mount Wall Bracket, 3U |
| 10629 | 8-26 | Raised Floor Rack Support Kit | 11592 | 9-7 | Rack Seismic Gusset Kit |
| 10630 | 8-26 | Raised Floor Rack Support Kit | 11643 | 8-29 | Mid-Size Rack Dolly |
| 10631 | 8-26 | Raised Floor Rack Support Kit | 11700 | 3-26 | End Closing Kit |
| 10632 | 8-26 | Raised Floor Rack Support Kit | 11729 | 2-25 | Vertical Cabling Section, Wide |
| 10642 | 3-20 | Protective End Caps | 11730 | 2-25 | Vertical Cabling Section, Narrow |
| 10684 | 3-21 | Tall Pipe Stand | 11746 | 3-18 | Triangular Support Bracket |
| 10695 | 9-8 | Earthquake Bracing Kits | 11752 | 2-32 | Rack Cabling Managers |
| 10696 | 9-8 | Earthquake Bracing Kits | 11753 | 2-32 | Rack Cabling Managers |
| 10697 | 3-22 | Threaded Rod Coupling Kit | 11754 | 10-6 | Flush-Mount Wall Bracket, 6U |
| 10702 | 3-17 | Spanner Kit | 11760 | 8-26 | Raised Floor Rack Support Kit |
| 10723 | 3-10 | Cable Runway Radius Bend | 11761 | 8-26 | Raised Floor Rack Support Kit |
| 10724 | 3-10 | Cable Runway Radius Bend | 11762 | 8-26 | Raised Floor Rack Support Kit |
| 10757 | 3-20 | Protective End Caps | 11763 | 8-26 | Raised Floor Rack Support Kit |
| 10758 | 8-18 | Small Peripheral Shelf | 11764 | 2-32 | Slip-On Cover, Ring Panel |
| 10812 | 2-33 | Composite Distribution Ring, CM | 11790 | 10-4 | Standard Swing Gate Wall Rack |
| 10822 | 3-10 | Cable Runway E-Bend | 11791 | 10-4 | Standard Swing Gate Wall Rack |
| 10873 | 3-24 | Slip-On Support Bracket | 11792 | 10-4 | Standard Swing Gate Wall Rack |
| 10941 | 2-33, 10-13 | Metal D-Rings | 11793 | 10-4 | Standard Swing Gate Wall Rack |
| 10942 | 2-33, 10-13 | Metal D-Rings | 11794 | 10-4 | Standard Swing Gate Wall Rack |
| 10943 | 2-33, 10-13 | Metal D-Rings | 11795 | 10-4 | Standard Swing Gate Wall Rack |
| 11054 | 8-19 | Shelf, 26" D | 11807 | 10-4 | Standard Swing Gate Wall Rack |
| 11085 | 3-22 | Threaded Rod Cover | 11808 | 10-4 | Standard Swing Gate Wall Rack |
| 11164 | 8-21 | Heavy Duty Shelf, 3" Channel | 11837 | 10-18 | Horizontal Wire Management Bar |
| 11231 | 8-20 | Double-Sided Shelf, Vented | 11840 | 10-12 | CUBE-IT Wall Mount Cabinet |
| 11268 | 3-26 | L Bracket | 11890 | 10-12 | CUBE-IT Wall Mount Cabinet |
| 11275 | 3-3 | UL Classified Cable Runway | 11900 | 10-12 | CUBE-IT Wall Mount Cabinet |
| 11293 | 8-18 | Low-Profile Shelf | 11901 | 10-12 | CUBE-IT Wall Mount Cabinet |

| Part # | Page # | Description |
|--------|--------|--|
| 11913 | 1-41 | Sliding Shelf, 32" D |
| 11914 | 1-41 | Sliding Shelf, 32" D |
| 11922 | 2-26 | Cabling Section Cover |
| 11923 | 2-26 | Cabling Section Cover |
| 11927 | 8-31 | RMU Label Kit |
| 11959 | 3-12 | Cable Runway Corner Bracket |
| 11960 | 10-7 | Fixed Wall-Mount Equipment Rack |
| 11961 | 10-7 | Fixed Wall-Mount Equipment Rack |
| 11962 | 10-7 | Fixed Wall-Mount Equipment Rack |
| 11963 | 10-7 | Fixed Wall-Mount Equipment Rack |
| 11964 | 10-7 | Fixed Wall-Mount Equipment Rack |
| 11965 | 10-7 | Fixed Wall-Mount Equipment Rack |
| 11972 | 1-36 | Seismic Frame Cabinet System |
| 11973 | 1-36 | Seismic Frame Cabinet System |
| 11996 | 10-12 | CUBE-IT Wall Mount Cabinet |
| 12096 | 2-25 | Vertical Cabling Section, Narrow |
| 12100 | 3-8 | Cable Runway Radius Drop |
| 12101 | 3-8 | Cable Runway Radius Drop |
| 12115 | 3-8 | Cable Runway Movable Cross Member |
| 12121 | 3-16 | Channel-To-Rack Mtg Plate, 3" |
| 12127 | 2-33 | Composite Distribution Ring |
| 12176 | 2-30 | Patch Panel Wire Mgmt Bar |
| 12183 | 2-31 | Jumper Tray |
| 12185 | 2-31 | Jumper Tray |
| 12186 | 2-31 | Transition Plate |
| 12187 | 2-31 | Jumper Tray |
| 12193 | 8-25 | Keyboard Tray, 19" Sliding |
| 12291 | 10-8 | Shelf, 10" D |
| 12293 | 8-21 | Heavy Duty Shelf, 6" Channel |
| 12309 | 8-32 | Rack Channel Standoffs |
| 12310 | 8-32 | Rack Channel Standoffs |
| 12311 | 8-32 | Rack Channel Standoffs |
| 12312 | 8-31 | Equipment Support Bracket |
| 12334 | 1-39 | Fixed Shelf |
| 12336 | 1-39 | Fixed Shelf |
| 12337 | 1-39 | Fixed Shelf |
| 12338 | 1-40 | Sliding Shelf |
| 12339 | 1-40 | Sliding Shelf |
| 12345 | 1-40 | Sliding Shelf |
| 12346 | 1-40 | Sliding Shelf |
| 12362 | 3-25 | Cable Runway Center Support |
| 12370 | 2-26 | Finger Snaps Cable Guides |
| 12407 | 9-7 | Adjustable Bracing Kits |
| 12408 | 3-15 | Channel-To-Rack Mtg Plate, 3" |
| 12409 | 3-16 | Channel-To-Rack Mtg Plate, 3" |
| 12419 | 10-12 | CUBE-IT Wall Mount Cabinet |
| 12465 | 1-35 | Vertical Cable Manager |
| 12477 | 9-7 | Adjustable Bracing Kits |
| 12480 | 1-34 | Fan Kit |
| 12510 | 1-34 | Filtered Ventilation System |
| 12511 | 1-34 | Filtered Ventilation System |
| 12539 | 1-37 | Hardware Kits |
| 12541 | 2-30 | Horizontal Wire Mgmt Panel for MCS/GCS |
| 12542 | 2-30 | Horizontal Wire Mgmt Panel for MCS/GCS |
| 12573 | 1-40 | Low Profile Fixed Shelf |
| 12610 | 1-40 | Low Profile Fixed Shelf |

| Part # | Page # | Description |
|--------|------------|---------------------------------------|
| 12637 | 1-37, 8-15 | Hardware Kits |
| 12638 | 1-37, 8-15 | Hardware Kits |
| 12639 | 1-37, 8-15 | Hardware Kits |
| 12664 | 2-26 | Cabling Section Cover |
| 12700 | 1-41, 8-14 | Sliding Shelf, Extra Heavy Duty |
| 12700 | 8-17 | Sliding Shelf, Heavy-Duty |
| 12717 | 8-24 | Flush Mount Keyboard Tray |
| 12730 | 3-15 | Channel-To-Rack Mtg Plate/Bracket, 3" |
| 12731 | 3-16 | Channel-To-Rack Mtg Plate/Bracket, 3" |
| 12751 | 8-22 | anyServer Bracket |
| 12752 | 8-22 | anyServer Bracket |
| 12759 | 8-22 | anyServer Bracket |
| 12766 | 2-28 | Fiber Management Spools, 2" |
| 12787 | 10-13 | Equipment Mounting Rails |
| 12795 | 10-4 | Heavy-Duty Swing Gate Brackets |
| 12803 | 10-18 | LED Light Kit |
| 12816 | 7-29, 10-8 | Power Strip, Horizontal |
| 12820 | 7-29, 10-8 | Power Strip |
| 12830 | 2-23 | Global Vertical Cabling Section |
| 12831 | 2-23 | Global Vertical Cabling Section |
| 12832 | 2-23 | Global Vertical Cabling Section |
| 12833 | 2-23 | Global Vertical Cabling Section |
| 12834 | 2-23 | Global Vertical Cabling Section |
| 12835 | 2-23 | Global Vertical Cabling Section |
| 12836 | 2-23 | Cable Ring for GVCS |
| 12848 | 7-28 | Power Strips, Metered |
| 12850 | 7-28 | Power Strips |
| 12858 | 10-5 | Corner Cushions |
| 12891 | 2-27 | Extended Fingers Bracket |
| 12934 | 10-20 | Surge-Suppressed Duplex Receptacle |
| 12955 | 10-19 | Fiber Stack Manager |
| 13050 | 10-19 | ThinLine II Wall-Mount Cabinet |
| 13051 | 10-20 | Intelligent Fan Kit, ThinLine |
| 13070 | 2-30 | Horizontal Wire Mgmt Panel for VCS |
| 13075 | 2-30 | Horizontal Wire Mgmt Panel for VCS |
| 13082 | 1-38 | Lockable Storage Drawer |
| 13082 | 8-23 | Lockable Storage Drawer |
| 13083 | 1-38, 8-23 | Lockable Storage Drawer |
| 13084 | 1-38 8-23 | Lockable Storage Drawer |
| 13168 | 1-35 | Enhanced Cable Manager |
| 13169 | 1-35 | Enhanced Cable Manager |
| 13170 | 1-35 | Enhanced Cable Manager |
| 13171 | 1-35 | Enhanced Cable Manager |
| 13183 | 2-31 | Jumper Tray |
| 13185 | 1-38 | Lockable Storage Drawer |
| 13239 | 7-29 | Power Strips, Horizontal, Metered |
| 13285 | 10-18 | Mounting Bracket, 90° |
| 13392 | 3-9 | Cable Runway Dividers |
| 13394 | 3-6 | PatchRack for Runway |
| 13395 | 3-6 | PatchRack for Runway |
| 13396 | 3-6 | Patch Rack D-Rings, 4U |
| 13399 | 3-6 | Cross Member Hardware Kit |
| 13483 | 10-13 | Foot Kit |
| 13492 | 10-15 | CUBE-IT Floor-Supported Cabinet |
| 13493 | 10-15 | CUBE-IT Floor-Supported Cabinet |
| 13495 | 10-15 | CUBE-IT Floor-Supported Cabinet |

| Part # | Page # | Description |
|--------|------------|---|
| 13496 | 10-15 | CUBE-IT Floor-Supported Cabinet |
| 13501 | 8-26 | Raised Floor Rack Support Kit |
| 13515 | 8-26 | Raised Floor Rack Support Kit |
| 13517 | 1-39 | Rack-Mount Cable Shelf |
| 13602 | 10-5 | EasySwing Wall-Mount Rack |
| 13604 | 10-5 | EasySwing Wall-Mount Rack |
| 13608 | 10-5 | EasySwing Wall-Mount Rack |
| 13622 | 5-3 | Bonding Busbars |
| 13671 | 1-37 | Raised Floor Grommet |
| 13696 | 9-4 | Cable Management Fingers Kit |
| 13697 | 9-5 | Vertical Power Strip Mounting Kit |
| 13698 | 9-5 | Duplex Electrical Outlet Box |
| 13699 | 9-5 | VCS Offset Bracket |
| 13704 | 9-5 | VCS Vertical Cabling Section |
| 13730 | 3-15 | Channel-To-Rack Mtg Plate w/Bracket, 3" |
| 13731 | 3-16 | Channel-To-Rack Mtg Plate w/Bracket, 3" |
| 13762 | 7-33 | PDU Mounting Bracket |
| 13772 | 11-4 | Zone, Raised Floor Enclosure |
| 13780 | 7-33 | PDU Mounting Bracket |
| 13812 | 11-6 | Zone, Ceiling Enclosures |
| 13813 | 11-7 | Zone, Ceiling Enclosures |
| 13833 | 11-11 | Wireless, Ceiling Enclosure |
| 13853 | 9-4 | SeismicFrame 2-Post Rack |
| 13854 | 9-4 | SeismicFrame 2-Post Rack |
| 13855 | 9-4 | SeismicFrame 2-Post Rack |
| 13856 | 9-4 | SeismicFrame 2-Post Rack |
| 13874 | 1-37 | Raised Floor Grommet |
| 13883 | 9-4 | SeismicFrame 2-Post Rack |
| 13884 | 9-4 | SeismicFrame 2-Post Rack |
| 13885 | 9-4 | SeismicFrame 2-Post Rack |
| 13886 | 9-4 | SeismicFrame 2-Post Rack |
| 13901 | 2-17 | Velocity Cable Manager, Single-sided |
| 13902 | 2-17 | Velocity Cable Manager, Single-sided |
| 13904 | 2-17 | Velocity Cable Manager, Single-sided |
| 13905 | 2-17 | Velocity Cable Manager, Single-sided |
| 13911 | 2-17 | Velocity Cable Manager, Double-sided |
| 13912 | 2-17 | Velocity Cable Manager, Double-sided |
| 13914 | 2-17 | Velocity Cable Manager, Double-sided |
| 13915 | 2-17 | Velocity Cable Manager, Double-sided |
| 13928 | 2-18 | Cable Lashing Bar Kit, Velocity |
| 13930 | 2-19 | Velocity Horizontal Cable Manager |
| 13934 | 2-18 | Cable Ring Kit, Velocity |
| 13935 | 2-18 | Cable Spool Kit, Velocity |
| 14068 | 1-35 | Vertical Cable Manager |
| 14070 | 1-39 | Fixed Shelf |
| 14072 | 1-39 | Fixed Shelf |
| 14300 | 3-4 | Adjustable Cable Runway |
| 14304 | 3-7 | Tool-less Cross Member Radius Drop |
| 14305 | 3-7 | Tool-less Stringer Radius Drop |
| 14307 | 3-5 | Adjustable Cable Runway Bonding Strap |
| 14308 | 3-5 | Tool-less Pathway Dividers |
| 14435 | 1-28, 9-12 | Air Dam Kit |
| 14440 | 1-29, 9-13 | Ring Cable Manager |
| 14445 | 1-29, 9-13 | Ring Cable Manager |
| 14465 | 1-28, 9-14 | Cable Lashing Bracket |
| 14480 | 1-29, 9-14 | Full Height PDU Bracket |

| Part # | Page # | Description |
|--------|-----------------|---|
| 14481 | 1-29 | Full Height PDU Bracket |
| 14485 | 1-28, 9-13 | Front-To-Rear Cable Manager |
| 14665 | 1-9, 4-10, 7-25 | USB Temp/Humidity Sensor |
| 14666 | 1-9, 4-10, 7-25 | eConnect RFD Electronic Lock |
| 14667 | 4-10 | Networked Electronic Access Control |
| 14668 | 4-11 | SSI Electronic Lock Kit |
| 14830 | 2-23 | Global Vertical Cabling Section |
| 14831 | 2-23 | Global Vertical Cabling Section |
| 14832 | 2-23 | Global Vertical Cabling Section |
| 15008 | 2-14, 2-28 | Cable Distribution Spools |
| 15053 | 8-15 | QuadraRack Server Frame |
| 1521X | 8-12 | Adjustable 4-Post Rack AQR/ASR |
| 1525X | 8-9 | Adjustable Rail 4-Post Rack ARQR/ARSR |
| 15205 | 8-14 | Mounting Bracket Kit |
| 15235 | 8-14 | Equipment Rail, AQR |
| 15245 | 8-13 | Solid Shelves, AQR |
| 15255 | 8-13 | Vented Shelves, AQR |
| 15259 | 8-10 | Fixed Rail |
| 15260 | 8-10 | Fixed Rail |
| 15270 | 8-10 | Side Panel |
| 15275 | 8-10 | Top-Mount Cable Waterfall Tray |
| 15285 | 8-10 | Equipment Rail |
| 15286 | 8-10 | Cable Guide |
| 15320 | 10-6 | Heavy-Duty Wall-Mount Equipment Rack |
| 15321 | 10-6 | Heavy-Duty Wall-Mount Equipment Rack |
| 15322 | 10-6 | Heavy-Duty Wall-Mount Equipment Rack |
| 15323 | 10-6 | Heavy-Duty Wall-Mount Equipment Rack |
| 15330 | 8-14 | Center Rail, AQR |
| 15335 | 8-14 | Center Rail, AQR |
| 15555 | 8-24 | Flush Mounted Keyboard Tray |
| 15556 | 8-24 | Flush Mounted Keyboard Tray |
| 15640 | 7-34 | Power Strips, Basic Horizontal, International |
| 15642 | 7-31 | Power Strips, Basic, International |
| 15643 | 7-32 | Power Strips, Metered, International |
| 15644 | 7-31 | Power Strips, Basic, International |
| 15645 | 7-32 | Power Strips, Metered, International |
| 16298 | 3-11 | Heavy-Duty Junction-Splice Kit |
| 16299 | 3-11 | Heavy-Duty Butt-Splice Kit |
| 16301 | 3-11 | Butt-Splice Kit |
| 16302 | 3-12 | Junction-Splice Kit |
| 16313 | 3-13 | 45° Runway Splice Kit |
| 16314 | 3-13 | 90° Runway Splice Kit |
| 16341 | 8-17 | Rack Base Dust Cover |
| 16342 | 8-17 | Rack Line-Up Spacer |
| 16350 | 8-17 | Heavy Duty Fixed Shelf, Vented, QR |
| 16351 | 8-17 | Heavy Duty Fixed Shelf, Solid, QR |
| 16356 | 8-17 | Equipment Tie-Down Bracket |
| 16487 | 3-14 | Butt-Swivel Splice Kit, UL |
| 16488 | 3-14 | Junction Swivel Splice Kit, UL |
| 16489 | 3-14 | Vertical Swivel Splice Kit, UL |
| 17000 | 2-34 | Mag Clips, Medium |
| 17100 | 2-34 | Mag Clips, Medium |
| 17500 | 2-34 | Mag Clips, Large |
| 17762 | 7-33 | Cord Retention Tethers, PDU |
| 17763 | 7-34 | Power Cords, IEC C20 PDU |
| 20015 | 3-28 | Split Lock Washers |

| Part # | Page # | Description |
|--------|-------------|--|
| 20017 | 3-28 | Hex Nuts |
| 20098 | 3-29 | Hex Lag Screw |
| 20141 | 3-28 | Split Lock Washers |
| 20142 | 3-28 | Hex Nuts |
| 20283 | 3-28 | Washer, Type A Plain |
| 20290 | 3-29 | Hex Cap Bolts |
| 25140 | 7-33 | PDU Mounting Bracket |
| 25190 | 1-14, 10-13 | Cable Port Brush Kit |
| 25400 | 3-27, 8-28 | Touch-Up Paint |
| 25401 | 3-27, 8-28 | Touch-Up Paint |
| 25500 | 10-9 | Standard Wall Mount Cabinet |
| 25501 | 10-9 | Standard Wall Mount Cabinet |
| 25502 | 10-9 | Standard Wall Mount Cabinet |
| 25503 | 10-9 | Standard Wall Mount Cabinet |
| 25504 | 10-9 | Standard Wall Mount Cabinet |
| 25505 | 10-9 | Standard Wall Mount Cabinet |
| 25512 | 10-10 | Cable Lashing Bracket, Std Wall |
| 25513 | 10-10 | Finger Cable Mgr, Std Wall |
| 25514 | 10-10 | Ring Cable Manager, Std Wall |
| 25515 | 10-10 | Fan Kit, Standard Wall Cabinet |
| 25521 | 10-10 | Rear Bracket Cable Mgr, Std Wall |
| 30013 | 8-33 | Block Mounting Bar |
| 30014 | 8-33 | Block Mounting Bar |
| 30015 | 8-33 | Block Mounting Bar |
| 30016 | 8-33 | Block Mounting Bar |
| 30024 | 8-28 | Filler Panels |
| 30025 | 8-28 | Filler Panels |
| 30026 | 8-28 | Filler Panels |
| 30027 | 8-28 | Filler Panels |
| 30091 | 2-20 | MCS Master Cabling Section |
| 30092 | 2-20 | MCS Master Cabling Section |
| 30093 | 2-20 | MCS Master Cabling Section |
| 30094 | 2-20 | MCS Master Cabling Section |
| 30095 | 2-20 | MCS Master Cabling Section |
| 30096 | 2-20 | MCS Master Cabling Section |
| 30097 | 2-20 | MCS Master Cabling Section |
| 30130 | 2-29 | Universal Horizontal Cable Manager, SS |
| 30131 | 2-29 | Universal Horizontal Cable Manager, SS |
| 30139 | 2-29 | Universal Horizontal Cable Manager, SS |
| 30161 | 2-21 | CCS Combination Cabling Section |
| 30162 | 2-21 | CCS Combination Cabling Section |
| 30163 | 2-21 | CCS Combination Cabling Section |
| 30164 | 2-21 | CCS Combination Cabling Section |
| 30165 | 2-21 | CCS Combination Cabling Section |
| 30166 | 2-21 | CCS Combination Cabling Section |
| 30330 | 2-29 | Universal Horizontal Cable Manager, SS |
| 30331 | 2-29 | Universal Horizontal Cable Manager, SS |
| 30339 | 2-29 | Universal Horizontal Cable Manager, SS |
| 30529 | 2-29 | Universal Horizontal Cable Manager, DS |
| 30530 | 2-29 | Universal Horizontal Cable Manager, DS |
| 30531 | 2-29 | Universal Horizontal Cable Manager, DS |
| 31410 | 8-31 | Rack Panel Adapters |
| 31420 | 8-31 | Rack Panel Adapters |
| 31430 | 8-31 | Rack Panel Adapters |
| 31440 | 8-31 | Rack Panel Adapters |
| 31450 | 8-31 | Rack Panel Adapters |

| Part # | Page # | Description |
|--------|-----------------|--|
| 31470 | 3-18 | Standoff Support Kit |
| 32573 | 2-6 | Cable Ring Kit, Motive |
| 32601 | 2-8 | Dual PDU Bracket Kit, Motive |
| 32602 | 2-8 | Side Panel Kit, Motive |
| 32604 | 2-7 | Rear Panel Kit, Motive |
| 32605 | 2-7 | Mid Panel Kit |
| 3261X | 2-4 | Motive Cable Management |
| 3262X | 2-4 | Motive Cable Management |
| 32650 | 2-4 | Accessory Rod Assembly, Motive |
| 32651 | 2-5 | Half Spool Kit, Motive |
| 32657 | 2-5 | Cable Bundle Swivel Kit, Motive |
| 32661 | 2-5 | Rotating Management Finger Kit, Motive |
| 32697 | 1-24 | Tool-Less Bend Radius Kit |
| 32697 | 2-6, 2-12, 2-27 | Tool-less Bend Radius Kit, Motive |
| 32770 | 1-43 | Aisle Containment Assembly Door |
| 32780 | 1-43 | Aisle Containment Assembly Door |
| 32780 | 1-44 | Door Mounting Bracket |
| 32805 | 1-44 | Door Mounting Bracket |
| 32817 | 1-45 | Door Top Seal Kit |
| 32870 | 1-44 | Door Standoff Kit |
| 32875 | 1-44 | Floor Mounting Template |
| 33000 | 1-48 | Build-To-Spec (BTS) Kit |
| 33001 | 1-49 | Corrugated Flute Cutter, BTS |
| 33002 | 1-49 | Full Height Blanking Panel, BTS |
| 33003 | 1-49 | Universal Bulb Seal, BTS |
| 34537 | 1-13, 9-12 | Snap-In Filler Panel |
| 34538 | 1-13, 9-12 | Snap-In Filler Panel |
| 34782 | 6-8 | Quarter-Height Mounting Plate, RMR |
| 35431 | 2-9 | Motive Horizontal Cable Manager |
| 35432 | 2-9 | Motive Horizontal Cable Manager |
| 35441 | 2-15 | Evolution Horizontal Cable Mgr |
| 35442 | 2-15 | Evolution Horizontal Cable Mgr |
| 35473 | 2-12 | Evolution Cable Lashing Bar Kit |
| 35475 | 2-12 | Evolution Fiber Segregation Kit |
| 35492 | 2-14 | Evolution Fixed Accessory Panel |
| 35493 | 2-14 | Evolution Movable Mid Section |
| 35497 | 2-13 | Evolution Solid Mid Panel |
| 35501 | 2-13 | Evolution Solid Rear Panel |
| 35502 | 2-13 | Evolution Solid Side Panel |
| 35503 | 2-12 | Evolution Cable Divider Bar Kit |
| 35505 | 2-14 | Cable Distribution Spool Spacer Kit |
| 35506 | 2-14 | Evolution Floor Bracket |
| 35511 | 2-11 | Evolution Cable Mgr, Single-Sided |
| 35512 | 2-11 | Evolution Cable Mgr, Single-Sided |
| 35513 | 2-11 | Evolution Cable Mgr, Single-Sided |
| 35514 | 2-11 | Evolution Cable Mgr, Single-Sided |
| 35515 | 2-11 | Evolution Cable Mgr, Single-Sided |
| 35521 | 2-11 | Evolution Cable Mgr, Double-Sided |
| 35522 | 2-11 | Evolution Cable Mgr, Double-Sided |
| 35523 | 2-11 | Evolution Cable Mgr, Double-Sided |
| 35524 | 2-11 | Evolution Cable Mgr, Double-Sided |
| 35525 | 2-11 | Evolution Cable Mgr, Double-Sided |
| 35571 | 2-11 | Evolution Cable Mgr, Combo |
| 35572 | 2-11 | Evolution Cable Mgr, Combo |
| 35573 | 2-11 | Evolution Cable Mgr, Combo |
| 35574 | 2-11 | Evolution Cable Mgr, Combo |

| Part # | Page # | Description | Part # | Page # | Description |
|--------|------------|--|--------|--------|---|
| 35575 | 2-11 | Evolution Cable Mgr, Combo | 37908 | 6-43 | Closed Loop Cooling |
| 35700 | 7-33 | PDU Mounting Bracket | 37912 | 6-43 | Roxtec Sealing Systems, RMR |
| 36516 | 7-26 | Power IQ, eConnect, Hardware | 37913 | 6-43 | Roxtec Sealing Systems, RMR |
| 36603 | 7-26 | Power IQ, eConnect | 37914 | 6-43 | Roxtec Sealing Systems, RMR |
| 36604 | 7-26 | Power IQ, eConnect, Licenses | 37915 | 6-43 | Roxtec Sealing Systems, RMR |
| 36605 | 7-26 | Power IQ, eConnect, Support Services | 37916 | 6-43 | RMR Gland Seal |
| 36650 | 7-25 | eConnect EAC Locking Kit | 37917 | 6-43 | RMR Gland Seal |
| 36651 | 4-10, 7-25 | Lock Door Sensor | 37920 | 6-40 | RMR Filter Fans |
| 36652 | 4-10, 7-25 | Lock Wire Harness Kit | 37940 | 6-10 | Hardware Kits |
| 36653 | 4-10, 7-25 | Lock RFID Smart Card Reader | 37941 | 6-10 | Hardware Kits |
| 36654 | 4-10, 7-25 | Lock RFID Smart Cards | 37942 | 6-10 | Hardware Kits |
| 37008 | 6-19 | Enclosure Busbar Kit | 39033 | 1-16 | Side Panel with Grommet Seal Openings |
| 37009 | 6-19 | Grounding Lug Kit, RMR Wall | 39037 | 1-16 | Side Panel with Grommet Seal Openings |
| 37045 | 6-16 | Wall-Mounting Kit, RMR | 39043 | 1-15 | Side Panel 4-Slide, Brush Seal Openings |
| 37049 | 6-17 | Lag Bolt Mounting Kit | 39047 | 1-15 | Side Panel 6-Slide, Brush Seal Openings |
| 37065 | 6-16 | Equipment Mounting Rails, RMR | 39076 | 1-17 | Seal Kit |
| 37067 | 6-16 | Equipment Mounting Rails, RMR | 39077 | 1-16 | Front-To-Rear Cable Manager |
| 37075 | 6-17 | Mounting Plates, RMR Wall | 39085 | 1-13 | Air Dam Kit |
| 37076 | 6-17 | Mounting Plates, RMR Wall | 39086 | 1-10 | Full Height PDU Brackets |
| 37082 | 6-18 | Vertical Lashing Bracket | 39087 | 1-12 | Ring Cable Manager |
| 37084 | 6-19 | Front-To-Rear Cable Lashing Bracket, RMR | 39088 | 1-12 | Ring Cable Manager |
| 37086 | 6-18 | Short Finger Cable Manager | 39107 | 1-16 | Air Director |
| 37097 | 6-19 | Brush Cable Entry Grommet, RMR Wall | 39110 | 7-33 | PDU Mounting Bracket |
| 37101 | 6-41 | RMR Filter Fans | 39112 | 1-11 | Finger Cable Manager |
| 37102 | 6-40 | RMR Filter Fans | 39113 | 1-15 | Equipment Rail Grommet Kit |
| 37115 | 6-43 | RMR EPDM Grommet | 39120 | 1-11 | Finger Cable Manager |
| 37116 | 6-40 | RMR Filter Fans | 39124 | 1-10 | Cable Lashing Bracket |
| 37117 | 6-40 | RMR Filter Fans | 39127 | 1-12 | Ring Cable Manager |
| 37239 | 6-11 | Document Holder, RMR | 39128 | 1-23 | Ring Cable Manager |
| 37770 | 6-11 | Front-to-Rear Support Slides, RMR | 39129 | 1-23 | Ring Cable Manager |
| 37771 | 6-5 | Equipment Mounting Rails, RMR | 39130 | 1-13 | Air Dam Kit |
| 37772 | 6-5 | Equipment Mounting Rails, RMR | 39131 | 1-10 | Cable Lashing Bracket |
| 37774 | 6-5 | Equipment Mounting Rails, RMR | 39132 | 1-14 | Bottom Panel |
| 37775 | 6-5 | Equipment Mounting Rails, RMR | 39133 | 9-12 | Equipment Rail Grommet Kit, Z4 |
| 37777 | 6-10 | Bracket Kit, Mounting Plate, RMR | 39137 | 1-17 | Bay Seal Kit |
| 37780 | 6-9 | Full-Height Mounting Plate | 39150 | 1-17 | Adjustment Tool, Leveling Feet |
| 37787 | 6-10 | Full-Height Baying Mounting Plate, RMR | 39177 | 1-14 | Vertical Exhaust Duct |
| 37800 | 6-6 | Cable Lashing Bracket | 39207 | 1-17 | Ramp Kit |
| 37801 | 6-8 | Ring Cable Manager, RMR | 39208 | 1-45 | Floor Seal Kit |
| 37802 | 6-8 | Ring Cable Manager, RMR | 39209 | 1-45 | Floor Seal Kit |
| 37803 | 6-8 | Short Ring Cable Manager, RMR | 39221 | 1-10 | Full Height PDU Brackets |
| 37808 | 6-7 | Dual PDU Bracket Kit, RMR | 39235 | 1-11 | Finger Cable Manager |
| 37809 | 6-7 | Dual PDU Bracket Kit, RMR | 39327 | 1-24 | Radius Drop |
| 37820 | 6-11 | Baying Kit, RMR | 39377 | 1-23 | Telescoping Cable Manager |
| 37823 | 6-11 | Eyebolt Baying Kit, RMR | 39380 | 1-24 | Cable Lashing Manager |
| 37825 | 6-11 | Internal Baying Kit, RMR | 39381 | 1-24 | Cable Lashing Manager |
| 37830 | 6-6 | Enclosure Plinth Base, RMR | 39721 | 6-40 | RMR Filter Fans |
| 37840 | 6-9 | Half-Height Mounting Plate, RMR | 40056 | 8-30 | Equipment Guard Rail |
| 37850 | 6-7 | Finger Cable Manager, RMR | 40057 | 8-30 | Equipment Guard Rail |
| 37860 | 6-7 | Finger Cable Manager, RMR | 40058 | 8-30 | Equipment Guard Rail |
| 37865 | 6-7 | Finger Cable Manager, RMR | 40059 | 8-30 | Equipment Guard Rail |
| 37898 | 6-40 | RMR Filter Fans | 40074 | 10-8 | Shelf, 15"D |
| 37900 | 6-42 | Closed Loop Cooling | 40074 | 8-18 | Single-Sided Shelf |
| 37901 | 6-42 | Closed Loop Cooling | 40075 | 8-18 | Single-Sided Shelf |
| 37902 | 6-40 | Fan Power Cord | 40091 | 2-20 | MCS Master Cabling Section |
| 37903 | 6-40 | RMR Filter Fans | 40092 | 2-20 | MCS Master Cabling Section |

| Part # | Page # | Description |
|--------|------------|-----------------------------------|
| 40093 | 2-20 | MCS Master Cabling Section |
| 40094 | 2-20 | MCS Master Cabling Section |
| 40095 | 2-20 | MCS Master Cabling Section |
| 40096 | 2-20 | MCS Master Cabling Section |
| 40097 | 2-20 | MCS Master Cabling Section |
| 40098 | 2-22 | CCS Combination Cabling Section |
| 40099 | 2-22 | CCS Combination Cabling Section |
| 40100 | 2-22 | CCS Combination Cabling Section |
| 40108 | 8-20 | Double-Sided Shelf |
| 40117 | 8-18 | Single-Sided Vented Shelf |
| 40118 | 8-18 | Single-Sided Vented Shelf |
| 40153 | 5-3 | Bonding Busbars |
| 40156 | 5-5 | Busbar Assembly |
| 40157 | 5-8 | Rack Busbar Insulator Block |
| 40158 | 5-5 | Busbar Assembly |
| 40159 | 5-9, 10-16 | Equipment Bonding Jumper Kit |
| 40160 | 5-6, 6-11 | Vertical Rack Busbar |
| 40161 | 5-7 | Vertical Rack Busbar Kits |
| 40162 | 5-13 | Compression Lugs |
| 40163 | 5-14 | C-Type Compression Taps |
| 40164 | 5-9 | Cable Runway Bonding Strap Kit |
| 40165 | 5-13 | Compression Tools |
| 40166 | 5-12 | Joint Compound |
| 40168 | 5-12 | Joint Compound |
| 40169 | 5-11 | Pedestal Clamp |
| 40170 | 5-11 | Pipe Clamp |
| 40172 | 5-6 | Vertical Rack Bonding Bar Kit |
| 40604 | 8-26 | Rack Installation Kits |
| 40605 | 1-37 | Hardware Kits |
| 40605 | 5-12 | Clean-Thread Screws |
| 40605 | 8-33 | Mounting Screws |
| 40606 | 8-33 | Mounting Screws |
| 40607 | 8-26 | Rack Installation Kits |
| 40750 | 8-19 | Standard Single-Sided Steel Shelf |
| 40751 | 8-19 | Standard Double-Sided Steel Shelf |
| 40970 | 10-17 | Vertical Cabling Section |
| 40971 | 10-17 | Vertical Lashing Bracket |
| 40972 | 10-16 | Standard Fan/Filter Kit |
| 40974 | 10-18 | Rack-Mount Shelf |
| 40975 | 10-16 | Low-Decible Dual-Fan/Filter Kit |
| 41021 | 8-27 | Base Angle |
| 41050 | 8-30 | Rack Base Cover |
| 42050 | 8-30 | Equipment Guard Rail |
| 46053 | 8-4 | Universal Rack |
| 46083 | 8-4 | Universal Rack |
| 46353 | 8-4 | Universal Rack |
| 46383 | 8-4 | Universal Rack |
| 46753 | 8-4 | Universal Rack |
| 46783 | 8-4 | Universal Rack |
| 48353 | 8-4 | Universal Rack |
| 48383 | 8-4 | Universal Rack |
| 50110 | 8-16 | ExpandaRack |
| 50120 | 8-16 | QuadraRack 4-Post Frame |
| 50130 | 8-16 | ExpandaRack |
| 50150 | 8-16 | ExpandaRack |
| 50160 | 8-16 | ExpandaRack |

| Part # | Page # | Description |
|----------|------------|---------------------------------------|
| 55053 | 8-6 | Standard Rack, 3" D |
| 57001 | 2-24 | Global Standard Pack |
| 57002 | 2-24 | Global Standard Pack |
| 57003 | 2-24 | Global Standard Pack |
| 57004 | 2-24 | Global Standard Pack |
| 57011 | 2-19 | Velocity Standard Pack |
| 57012 | 2-19 | Velocity Standard Pack |
| 57013 | 2-19 | Velocity Standard Pack |
| 57014 | 2-19 | Velocity Standard Pack |
| 60100 | 4-3 | Remote Infrastructure Mgmt (RIM-750) |
| 60101 | 4-7 | Remote Infrastructure Mgmt (RIM-1000) |
| 60103 | 4-5 | RIM Expansion Cards |
| 60106 | 4-9 | RIM Protocol Converter |
| 60107 | 4-4 | Rack-Mount Bracket |
| 60108 | 4-4 | Sensor, Temperature |
| 60109 | 4-4 | Sensor, Leak Detector |
| 60110 | 4-4 | Sensor, Power Fail |
| 60111 | 4-8 | Sensor, Temperature |
| 60112 | 4-8 | Sensor, Temperature |
| 60113 | 4-4 | Sensor, Smoke Detector |
| 60114 | 4-4 | Sensor, Motion Detector |
| 60115 | 4-4 | Sensor, Door |
| 60116 | 4-4 | Sensor, Leak Detection Cable |
| 60500 | 3-26 | Radius Drop |
| 60501 | 3-35 | Wall Angle Support Kit |
| 60506 | 3-35 | Elevation Kit |
| 66353 | 8-7 | Standard Rack, 6" D |
| 66363 | 8-7 | Standard Rack, 6" D |
| 66383 | 8-7 | Standard Rack, 6" D |
| 76543 | 1-38, 8-15 | Clik-Nut Hardware Kit |
| 76544 | 1-38 | Clik-Nut Hardware Kit |
| 76545 | 1-38 | Clik-Nut Hardware Kit |
| 67010053 | 3-33 | PEMSA Splice Plate |
| 67020139 | 3-36 | PEMSA Data Outlet Radius Drop |
| 68000032 | 3-32 | PEMSA Bonding Connector |
| 68000033 | 3-32 | PEMSA Bonding Connector |
| 68000110 | 3-26 | PEMSA Cable Tie Clip |
| 602XXXXX | 3-31 | PEMSA Rejiband Wire Tray |
| 620X1104 | 3-33 | PEMSA SPLUS Omega Bracket |
| 620X1154 | 3-33 | PEMSA SPLUS Omega Bracket |
| 620X1204 | 3-33 | PEMSA SPLUS Omega Bracket |
| 620X1304 | 3-33 | PEMSA SPLUS Omega Bracket |
| 620X1404 | 3-33 | PEMSA SPLUS Omega Bracket |
| 620X1504 | 3-34 | PEMSA SPLUS Omega Pendant |
| 620X1604 | 3-34 | PEMSA SPLUS Omega Pendant |
| 620X2104 | 3-33 | PEMSA SPLUS Omega Ceiling Bracket |
| 620X2154 | 3-33 | PEMSA SPLUS Omega Ceiling Bracket |
| 620X2204 | 3-33 | PEMSA SPLUS Omega Ceiling Bracket |
| 620X2304 | 3-33 | PEMSA SPLUS Omega Ceiling Bracket |
| 620X2404 | 3-33 | SPLUS Omega Ceiling Bracket |
| 620X5103 | 3-34 | PEMSA RPLUS Med Duty Cantilever Brkt |
| 620X5153 | 3-34 | PEMSA RPLUS Med Duty Cantilever Brkt |
| 620X5203 | 3-34 | PEMSA RPLUS Med Duty Cantilever Brkt |
| 620X5303 | 3-34 | PEMSA RPLUS Med Duty Cantilever Brkt |
| 620X5403 | 3-34 | PEMSA RPLUS Med Duty Cantilever Brkt |
| 620X5503 | 3-34 | PEMSA RPLUS Med Duty Cantilever Brkt |

| Part # | Page # | Description |
|------------|--------|--------------------------------------|
| 620X5603 | 3-34 | PEMSA RPLUS Med Duty Cantilever Brkt |
| 620X6010 | 3-26 | PEMSA Mini Universal Bracket |
| 620X6011 | 3-26 | PEMSA Universal Bracket |
| 630X2104 | 3-34 | PEMSA SPLUS Omega Channel |
| 630X2154 | 3-34 | PEMSA SPLUS Omega Channel |
| 630X2204 | 3-34 | PEMSA SPLUS Omega Channel |
| 630X2304 | 3-34 | PEMSA SPLUS Omega Channel |
| 630X2404 | 3-34 | PEMSA SPLUS Omega Channel |
| 630X2504 | 3-34 | PEMSA SPLUS Omega Channel |
| 630X2604 | 3-34 | PEMSA SPLUS Omega Channel |
| 640X0060 | 3-32 | PEMSA Part Clamp |
| 640X0061 | 3-32 | PEMSA Reinforced Joint Clamp |
| 640X0158 | 3-32 | PEMSA Access Clamp Hardware Kit |
| 670X0043 | 3-35 | PEMSA Click Central Hanging Plate |
| A0222 | 11-4 | Zone, Raised Floor Enclosure |
| A04-XXXXXX | 6-21 | RMR Floor Mount, Type 12 |
| A0422 | 11-4 | Zone, Raised Floor Enclosure |
| A05-XXXXXX | 6-22 | RMR Floor Mount, Type 4 |
| A06-XXXXXX | 6-24 | RMR Free-Standing, Type 12 |
| A0622 | 11-4 | Zone, Raised Floor Enclosure |
| A07-XXXXXX | 6-24 | RMR Free-Standing, Type 12 |
| A08-XXXXXX | 6-25 | RMR Free-Standing, Type 4 |
| A0822 | 11-4 | Zone, Raised Floor Enclosure |
| A09-XXXXXX | 6-26 | RMR Free-Standing, Type 4 |
| A1-XXXX | 6-4 | RMR Modular Enclosure |
| A10-XXXXXX | 6-27 | RMR Free-Standing, Type 4&12 |
| A1024 | 11-6 | Zone, Ceiling Enclosures |
| A11-XXXXXX | 6-29 | RMR Standard Wall-Mount, Type 4 &12 |
| A12-XXXXXX | 6-30 | RMR Standard Wall-Mount, Type 12 |
| A1222 | 11-6 | Zone, Ceiling Enclosures |
| A13-XXXXXX | 6-31 | RMR Standard Wall-Mount, Type4 |
| A1411 | 11-5 | Zone, Raised Floor Enclosure, Active |
| A1422 | 11-4 | Zone, Raised Floor Enclosure |
| A2-XXXX | 6-15 | RMR Fixed Wall-Mount Enclosure |
| A3-XXXX | 6-13 | RMR Swing Wall-Mount Enclosure |
| A30-XXXXXX | 6-33 | RMR Disconnect Floor-Mount 4/4X |
| A31-XXXXXX | 6-35 | RMR Disconnect Free-Standing 4/4X |
| A32-XXXXXX | 6-35 | RMR Disconnect Free-Standing 4/4X |
| A33-XXXXXX | 6-37 | RMR Disconnect Wall-Mount 4/4X |
| A34-XXXXXX | 6-37 | RMR Disconnect Wall-Mount 4/4X |
| A50-XXXXXX | 6-21 | RMR Floor Mount, Type 12 SS |
| A51-XXXXXX | 6-22 | RMR Floor Mount, Type 4X SS |
| A52-XXXXXX | 6-24 | RMR Free-Standing, Type 12 SS |
| A54-XXXXXX | 6-25 | RMR Free-Standing, Type 4X |
| A55-XXXXXX | 6-26 | RMR Free-Standing, Type 4X |
| A56-XXXXXX | 6-27 | RMR Free-Standing, Type 4X |
| A57-XXXXXX | 6-29 | RMR Standard Wall-Mount, Type 4X |
| A58-XXXXXX | 6-30 | RMR Standard Wall-Mount, Type 12 SS |
| A59-XXXXXX | 6-31 | RMR Standard Wall-Mount, Type 4X |
| A70-XXXXXX | 6-33 | RMR Disconnect Floor-Mount 4/4X SS |
| A71-XXXXXX | 6-35 | RMR Disconnect Free-Standing 4/4X SS |
| A72-XXXXXX | 6-35 | RMR Disconnect Free-Standing 4/4X SS |
| A73-XXXXXX | 6-37 | RMR Disconnect Wall-Mount 4/4X SS |
| A74-XXXXXX | 6-37 | RMR Disconnect Wall-Mount 4/4X SS |
| AAT-ACE | 11-11 | Wireless, Dome Enclosure |
| AAT-AWM-H | 11-13 | Zone Cabling Wall-Mount Enclosure |

| Part # | Page # | Description |
|--------------|-------------|-------------------------------------|
| AAT-CAP | 11-10 | Wireless Access Point Enclosures |
| AAT-MWME | 11-12, 6-44 | Wireless, NEMA-Rated Wall-Mount |
| AAT-WME-P | 11-12, 6-44 | Wireless, NEMA-Rated Wall-Mount |
| AAT-WMMSG | 11-13, 6-44 | Wireless, NEMA-Rated Wall-Mount |
| BCE-24 | 11-8 | Basic Consolidation Enclosures |
| Chrome Locks | 11-9 | Zone, Locks |
| DFO0XX | 6-38 | RMR Accessories |
| EO-1XXX | 7-5 | Basic eConnect PDU |
| E1-2XXX | 7-8 | Metered eConnect PDU |
| EA-3XXX | 7-11 | Monitored eConnect PDU |
| EA-4XXX | 7-14 | Monitored Pro eConnect PDU |
| EA-5XXXX | 7-18 | Switched eConnect PDU |
| EA-6XXXX | 7-20 | Switched Pro eConnect PDU |
| FXXX-XXXX | 1-5 | F-Series TerraFrame Cabinet |
| GF-XXXXX | 1-7 | GF-Series Cabinet |
| I5-XXXX | 7-24 | Switched eConnect 148 Outlet PDU |
| LX-NEXTWAR | 7-25 | Extended Limited Warranty |
| MXXXX-XXX | 1-31 | M-Series MegaFrame Cabinet |
| MXXXX-XXX | 1-33 | M-Series MegaFrame Cabinet, 48" |
| NXXX-XXXX | 1-20 | N-Series TerraFrame Network Cabinet |
| P5-XXXX | 7-23 | Horizontal eConnect PDU |
| RF-BRACKET | 11-9 | Mounting Brackets |
| Spare Keys | 11-9 | Keys, Zone Enclosures |
| WA064-WAP | 11-11 | Wireless, Ceiling Enclosure |
| Wire Cage | 1-50 | Wire Cage Enclosures |
| Z4-XXX-XXXX | 1-25, 9-10 | Z4-Series SeismicFrame Cabinet |

ALPHABETICAL LISTING

| Description | Page # |
|--|------------|
| Aisle Containment | |
| Build-To-Spec (BTS) Kit | 1-42 |
| Corrugated Flute Cutter | 1-49 |
| Door Assembly | 1-43 |
| Floor Seal Kit | 1-45 |
| Full Height Blanking Panel | 1-49 |
| Universal Bulb Seal | 1-49 |
| Bonding Busbars | |
| Bonding Busbars | 5-3 |
| Bonding Jumper | 5-10 |
| Compression Lug | 5-13 |
| Equipment Bonding Jumper Kit | 5-9 |
| Ground Wire | 5-10 |
| Horizontal Rack Busbar | 5-5 |
| Pedestal Clamp | 5-11 |
| Pipe Clamp | 5-11 |
| Standard Busbars | 5-4 |
| Cabinets | |
| F-Series TerraFrame Cabinet | 1-4 |
| GF-Series GlobalFrame Cabinet | 1-6 |
| M-Series MegaFrame Cabinet | 1-30 |
| N-Series TerraFrame Network Cabinet | 1-18 |
| Z4-Series SeismicFrame Cabinet | 1-25, 9-10 |
| F-Series TerraFrame/GF-Series GlobalFrame Accessories | |
| Air Dam Kit | 1-13 |
| Bottom Panel | 1-14 |
| Cable Lashing Bracket | 1-10 |
| Cable Port Brush Kit | 1-14 |

Description **Page #****F-Series TeraFrame/GF-Series GlobalFrame Accessories**

| | |
|--------------------------------------|-----------|
| eConnect RFID Electronic Locking Kit | 1-9, 7-25 |
| Finger Cable Manager | 1-11 |
| Front-To-Rear Cable Manager | 1-16 |
| Full Height PDU Brackets | 1-10 |
| Ring Cable Managers | 1-12 |
| Shelves, Cabinets | 1-39 |
| Side Panels | 1-15 |
| Thermal Management | 1-37 |
| Vertical Exhaust Duct | 1-14 |

M-Series MegaFrame Cabinet

| | |
|--------------------------|------|
| Cabinet, 72", 78" & 84"H | 1-31 |
| Cabinet, 48"H | 1-33 |
| Fan Kit | 1-34 |
| Vertical Cable Manager | 1-35 |

N-Series TeraFrame Network Cabinet

| | |
|---------------------------|------|
| Cable Lashing Manager | 1-24 |
| Radius Drop | 1-24 |
| Ring Cable Manager | 1-23 |
| Telescoping Cable Manager | 1-23 |
| Tool-Less Bend Radius Kit | 1-24 |
| Thermal Management | 1-37 |

Z4-Series SeismicFrame Cabinet

| | |
|-------------------------|------|
| Cabinet | 1-25 |
| Cable Lashing Bracket | 1-28 |
| Full Height PDU Bracket | 1-29 |

Cable Management

| | |
|---------------------------------|------|
| CCS Combination Cabling Section | 2-21 |
| Evolution Cable Management | 2-10 |
| Global Standard Pack | 2-24 |
| Global Vertical Cabling Section | 2-23 |
| MCS Master Cabling Section | 2-20 |
| Motive Cable Management | 2-3 |
| Velocity Cable Manager | 2-19 |

Cable Management Accessories

| | |
|---|------------|
| Accessory Rod Assembly, Motive | 2-5 |
| Cable Bundle Swivel Kit, Motive | 2-5 |
| Cable Distribution Spools | 2-14, 2-28 |
| Cable Lashing Bar Kit, Velocity | 2-19 |
| Cable Ring Kit, Motive | 2-6 |
| Cable Ring Kit, Velocity | 2-18 |
| Composite Distribution Ring | 2-33 |
| Click-Nut Hardware Kit | 1-45 |
| Dual PDU Bracket Kit, Motive | 2-8 |
| Extended Fingers Bracket | 2-27 |
| Fiber Management Spools, 2" | 2-28 |
| Fiber Segregation Kit, Evolution | 2-12 |
| Finger Snaps Cable Guides | 2-26 |
| Fixed Accessory Panel, Evolution | 2-14 |
| Half Spool Kit, Motive | 2-6 |
| Horizontal Ring Panel, Large | 2-32 |
| Horizontal Wire Mgmt Panel for VCS | 2-30 |
| Jumper Tray | 2-31 |
| Mag Clips | 2-34 |
| MCS Master Cabling Section, Ext Fingers | 2-20 |
| Metal D-Rings | 2-33 |

Description **Page #****Cable Management Accessories**

| | |
|--|------|
| Mid Panel Kit | 2-8 |
| Motive Horizontal Cable Managers | 2-9 |
| Movable Mid Section, Evolution | 2-14 |
| Patch Panel Wire Mgmt Bar | 2-30 |
| Rack Cabling Managers, CM | 2-32 |
| Rear Panel Kit, Motive | 2-7 |
| Rotating Management Finger Kit, Motive | 2-5 |
| Slip-On Cover, VCS | 2-30 |
| Solid Mid Panel, Evolution | 2-13 |
| Tool-less Bend Radius Kit | 2-27 |
| Transition Plate | 2-31 |
| Universal Horizontal Cable Manager | 2-29 |
| Velocity Horizontal Cable Manager | 2-19 |
| Velocity Standard Pack | 2-19 |
| Vertical Cabling Section | 2-25 |

Cable Tray & Accessories

| | |
|------------------------------|------|
| PEMSA Rejiband Wire Tray | 3-31 |
| Bonding Connector | 3-32 |
| SPLUS Omega Ceiling Brackets | 3-33 |
| SPLUS Omega Pendant | 3-34 |
| Click Central Hanging Plate | 3-35 |

CUBE-IT Wall Mount Enclosures

| | |
|--|-------|
| CUBE-IT Wall-Mount Cabinet | 10-12 |
| CUBE-IT Wall Mount Floor-Supported Cabinet | 10-15 |

CUBE-IT Wall Mount Enclosure Accessories

| | |
|----------------------------------|-----------|
| Cable Port Brush Kit | 10-13 |
| Foot Kit | 10-13 |
| Equipment Mounting Rails | 10-13 |
| Standard Fan/Filter Kit | 10-16 |
| Low-Decible Dual-Fan/Filter Kit | 10-16 |
| Replacement Filter Kit | 10-16 |
| eConnect PDU, Basic | 7-5 |
| eConnect PDU, Metered | 7-8 |
| eConnect PDU, Monitored | 7-11 |
| eConnect PDU, Monitored Pro | 7-14 |
| eConnect PDU, Switched | 7-20 |
| eConnect PDU, Switched Pro | 7-23 |
| Filler Panels | 1-13 |
| Hardware Kits | 1-44 |
| Lock Kits | 1-9, 7-25 |
| Lockable Storage Drawer | 1-45 |
| One Mounting Hole Terminal Block | 5-8 |

Power Management Products

| | |
|----------------------------|------|
| Basic eConnect PDU | 7-5 |
| Metered eConnect PDU | 7-8 |
| Monitored eConnect PDU | 7-11 |
| Monitored Pro eConnect PDU | 7-14 |
| Switched eConnect PDU | 7-20 |
| Switched Pro eConnect PDU | 7-23 |
| Horizontal eConnect PDUs | 7-23 |

Power Management Accessories

| | |
|------------------------------------|------|
| Environmental Probe & Sensor | 7-23 |
| Power IQ, eConnect | 7-24 |
| Power Strips, Basic, International | 7-29 |
| Power Cords, IEC C20 PDU | 7-33 |

| Description | Page # |
|--|-----------|
| Power Management Accessories | |
| PDU Mounting Bracket | 7-33 |
| RFID Electronic Locking Kit | 1-9, 7-25 |
| Rack Systems | |
| Adjustable 4-Post Rack AQR/ASR | 8-11 |
| Adjustable Rail 4-Post Rack ARQR/ARSR | 8-8 |
| Universal Rack | 8-3 |
| QuadraRack 4-Post Frame | 8-16 |
| QuadraRack Server Frame | 8-15 |
| SeismicFrame 2-Post Rack | 9-4 |
| Standard Rack, 3" | 8-6 |
| Rack System Accessories | |
| Equipment Rail | 8-10 |
| Hardware Kits | 8-15 |
| Rack Installation Kits | 8-26 |
| Rack Channel Standoffs | 8-32 |
| Shelves | 8-18 |
| Top-Mount Cable Waterfall Tray | 8-10 |
| Remote Infrastructure Management | |
| Remote Infrastructure Mgmt (RIM-750) | 4-3 |
| Remote Infrastructure Mgmt (RIM-1000) | 4-7 |
| Remote Infrastructure Mgmt, Protocol Converter | 4-9 |
| Sensors, RIM-750 | 4-4 |
| Sensors, RIM-1000 | 4-8 |
| RMR Industrial Enclosures | |
| RMR Disconnect Floor-Mount 4/4X | 6-33 |
| RMR Disconnect Floor-Mount 4/4X SS | 6-33 |
| RMR Disconnect Free-Standing 4/4X | 6-35 |
| RMR Disconnect Free-Standing 4/4X SS | 6-35 |
| RMR Disconnect Wall-Mount 4/4X | 6-37 |
| RMR Disconnect Wall-Mount 4/4X SS | 6-37 |
| RMR Fixed Wall-Mount Enclosure | 6-15 |
| RMR Floor Mount, Type 12 | 6-21 |
| RMR Floor Mount, Type 4 | 6-22 |
| RMR Floor Mount, Type 12 SS | 6-21 |
| RMR Floor Mount, Type 4X SS | 6-22 |
| RMR Free-Standing, Type 12 | 6-24 |
| RMR Free-Standing, Type 4 | 6-26 |
| RMR Free-Standing, Type 4 & 12 | 6-27 |
| RMR Free-Standing, Type 12 SS | 6-24 |
| RMR Free-Standing, Type 4X | 6-25 |
| RMR Standard Wall-Mount, Type 4 & 12 | 6-29 |
| RMR Standard Wall-Mount, Type 12 | 6-30 |
| RMR Standard Wall-Mount, Type 4 | 6-31 |
| RMR Standard Wall-Mount, Type 4X | 6-29 |
| RMR Standard Wall-Mount, Type 12 SS | 6-30 |
| RMR Standard Wall-Mount, Type 4X | 6-31 |
| RMR Swing Wall-Mount Enclosure | 6-13 |
| RMR Industrial Enclosure Accessories | |
| Bracket Kit, Mounting Plate | 6-7 |
| Brush Cable Entry Grommet, RMR Wall | 6-19 |
| Closed Loop Cooling | 6-33 |
| Dual PDU Bracket Kit | 6-10 |
| Enclosure Busbar Kit | 6-19 |
| Enclosure Plinth Base, RMR | 6-8 |
| LED Light Kit | 6-29 |

| Description | Page # |
|--|--------|
| RMR Enclosure Accessories | |
| Mounting Plates, RMR Wall | 6-16 |
| Ring Cable Manager, RMR | 6-10 |
| RMR EPDM Snap-In Grommet | 6-34 |
| Roxtec Sealing Systems, RMR | 6-34 |
| Runway Products | |
| Adjustable Cable Runway | 3-4 |
| Universal Cable Runway | 3-3 |
| UL Classified Cable Runway | 3-3 |
| Runway Accessories | |
| 45° Runway Splice Kit | 3-13 |
| 90° Runway Splice Kit | 3-13 |
| Adjustable Cable Runway Grounding Strap | 3-5 |
| Butt Splice Kit | 3-11 |
| Cable Runway Center Support | 3-25 |
| Cable Runway Corner Bracket | 3-12 |
| Cable Runway Dividers | 3-9 |
| Cable Runway Elevation Kit | 3-17 |
| Cable Runway Movable Cross Member | 3-8 |
| Cable Runway Radius Bend | 3-10 |
| Cable Runway Radius Drop | 3-8 |
| Ceiling Support Bracket | 3-23 |
| Channel-To-Rack Mtg Plate, 3" | 3-15 |
| Cross Member Hardware Kit | 3-6 |
| Heavy-Duty Butt-Splice Kit | 3-11 |
| Hex Cap Bolts | 3-29 |
| J-Bolt Kit | 3-19 |
| Junction-Splice Kit | 3-12 |
| L Bracket | 3-26 |
| PatchRack for Runway | 3-6 |
| Runway Support Brackets | 3-237 |
| Standoff Support Kit | 3-18 |
| Threaded Ceiling Kit | 3-20 |
| Tool-less Pathway Dividers | 3-5 |
| Wall Angle Support Kit | 3-19 |
| Seismic Systems | |
| SeismicFrame 2-Post Rack | 9-4 |
| Cable Management Fingers Kit | 9-4 |
| Duplex Electrical Outlet Box | 9-5 |
| Universal Earthquake Bracing Kit | 9-6 |
| Rack Seismic Gusset Kit | 9-7 |
| Z4-Series SeismicFrame Cabinet System | 9-10 |
| Shelves, Cabinets | 1-39 |
| Wall-Mount Enclosures | |
| CUBE-iT Wall Mount Cabinet | 10-12 |
| CUBE-iT Wall Mount Floor-Supported Cabinet | 10-15 |
| EasySwing Wall-Mount Rack | 10-5 |
| Fixed Wall-Mount Equipment Rack | 10-7 |
| Heavy-Duty Wall-Mount Equipment Rack | 10-6 |
| Standard Swing Gate Wall Rack | 10-4 |
| Standard Wall Mount Cabinet | 10-9 |
| ThinLine II Wall-Mount Cabinet | 10-19 |
| Wire Cage Enclosures | 1-60 |
| Wireless, Ceiling Enclosure | 11-11 |
| Wireless Access Point Enclosures | 11-10 |
| Zone, Basic Enclosures | 11-8 |

CPI SOLUTIONS GUIDE

chatsworth.com
techsupport@chatsworth.com

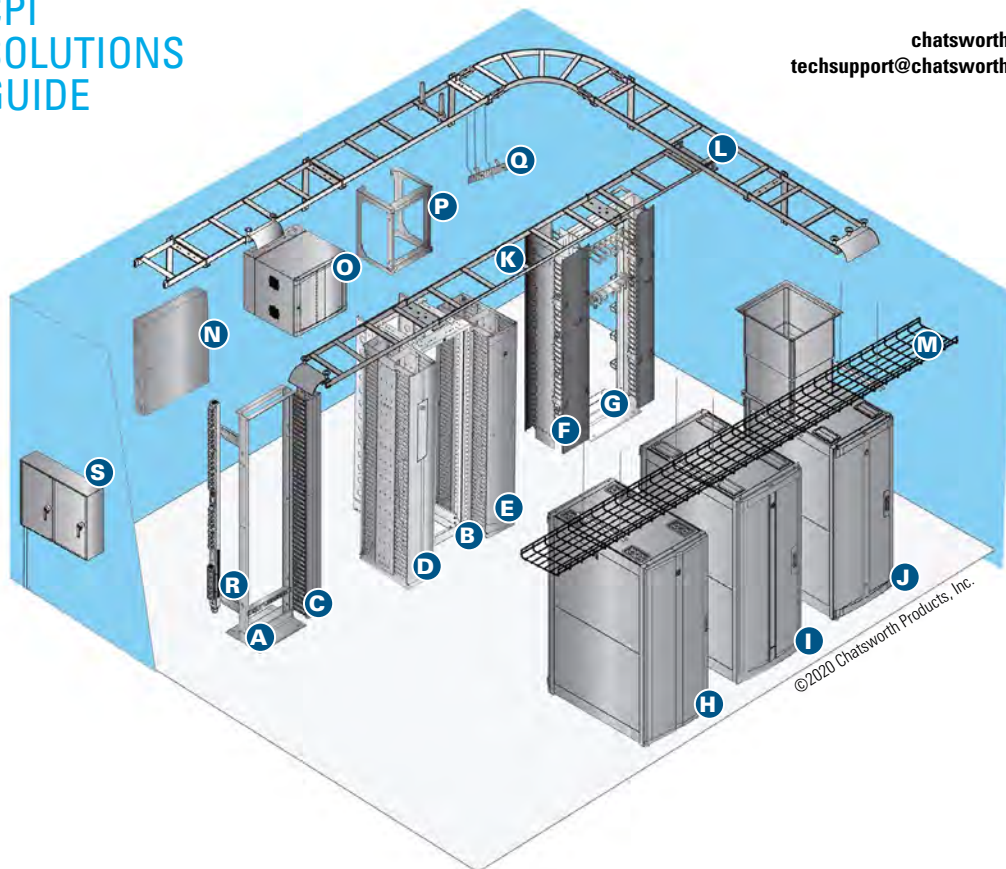

©2020 Chatsworth Products, Inc.

Rack Systems

- A – Two-Post Standard Rack
- B – Adjustable Rail Server Rack

Wall-Mount Rack

- P – Standard Swing Gate Wall Rack

Cabinets

- H – GF-Series GlobalFrame® Gen 2
- I – F-Series TeraFrame® Gen 3
- J – F-Series TeraFrame Gen 3 with Vertical Exhaust Duct

Cable Management

- C – Velocity® Cable Management
- D – Motive® Cable Management
- E – Evolution® Cable Management
- F – MCS Master Cabling Section
- G – CCS Combination Cabling Section

Cable Pathway

- K – Adjustable Cable Runway
- L – Universal Cable Runway
- M – PEMSA® Rejiband® Wire Mesh Cable Tray

Wall-Mount Cabinets

- N – ThinLine II Wall-Mount Cabinet
- O – CUBE-it™ Wall-Mount Cabinet

Grounding and Bonding

- Q – Primary and Secondary Busbars

Power

- R – eConnect® PDUs

Industrial Enclosures

- S – RMR® Enclosures



CHATSWORTH
PRODUCTS

United States & Canada

Agoura Hills, CA
800-834-4969
Toronto, Ontario, Canada
+905-850-7770
chatsworth.com

Latin America

+52-55-5203-7525
Toll Free within Mexico
01-800-201-7592
chatsworth.com.co

Europe

+44-1628-524-834
chatsworth.com

Middle East & Africa

Dubai, UAE
+971-4-2602125
Qatar
+974-4-4267422
chatsworth.com

Asia Pacific

+86 21 6880-0266
chatsworth.com.cn

Find more information
about CPI solutions at:
chatsworth.com

+1-800-834-4969 (U.S. & Canada)
or techsupport@chatsworth.com

Catalog Includes

- Cabinet & Aisle Containment Systems
- Cable Management Products
- Cable Runway & Tray Products
- Environmental Monitoring & Security Systems
- Bonding & Grounding Products
- Industrial Enclosure Systems
- Power Management Products
- Rack Systems
- Seismic Protection Systems
- Wall-Mount Systems
- Zone Cabling & Wireless Enclosures

Manufacturing Capability and Global Availability

Headquartered in the United States, CPI operates from multiple sites worldwide, including offices in Mexico, Canada, China, the Middle East and the United Kingdom. CPI's manufacturing facilities are located in the United States, Asia and Europe.

Standard products are readily available through a global network of industry-leading distributors. With stock availability, and CPI's consistently short factory lead times, you can be assured that CPI solutions will be accessible to meet your project scheduling needs.



All products quoted are subject to availability based on manufacturing capacity and shipping dates should be considered estimates only. While every effort has been made to ensure the accuracy of all information, CPI does not accept liability for any errors or omissions and reserves the right to change information and descriptions of listed services and products.

©2020 Chatsworth Products, Inc. All rights reserved. Chatsworth Products, Click-Nut, CPI, CPI Passive Cooling, eConnect, Evolution, GlobalFrame, MegaFrame, Motive, QuadraRack, RMR, Saf-T-Grip, Secure Array, SeismicFrame, SlimFrame, TeraFrame and Velocity are federally registered trademarks of Chatsworth Products. CUBE-IT, EuroFrame and Simply Efficient are trademarks of Chatsworth Products. All other trademarks belong to their respective companies. Published 03/20 MKT-60020-734

